

Edinburgh Mathematical Society.

LIST OF MEMBERS.

EIGHTEENTH SESSION 1899-1900.

- 1 V. RAMASWAMI AIYAR, M.A., Prob. Dy. Collector, Trichinopoly, India.
JOHN ALISON, M.A., F.R.S.E., George Watson's College, Edinburgh.
ERNEST M. ANDERSON, M.A., B.Sc., Ewart High School, Newton Stewart.
JAMES ARCHIBALD, M.A., Castlehill School, Edinburgh (*Honorary Treasurer*).
- 5 PAUL AUBERT, Professeur au Collège Stanislas, Paris.
A. J. GUNION BARCLAY, M.A., F.R.S.E., High School, Glasgow.
E. P. BARRETT, B.A., Marling School, Stroud.
J. C. BEATTIE, D.Sc., F.R.S.E., Professor of Applied Mathematics and Experimental Physics, South African College, Cape Town.
ROBT. J. T. BELL, M.A., B.Sc., Portland Park, Hamilton.
- 10 PETER BENNETT, Glasgow and West of Scotland Technical College, Glasgow.
JAMES BOLAM, Government Navigation School, Leith.
HENRY A. BRAINE, M.A., Headmaster, Castle Douglas.
A. BROWN, M.A., B.Sc., Gonville and Caius College, Cambridge.
H. H. BROWNING, B.D., 128 Byres' Road, Glasgow.
- 15 J. BRUCE-KINGSMILL, R.A., 15 Kyle Park, Uddingston.
JAMES BUCHANAN, M.A., 9 St. Andrew Square, Edinburgh.
J. R. BURGESS, M.A., Merchiston Castle, Edinburgh.
J. W. BUTTERS, M.A., B.Sc., F.R.S.E., Rector, The Academy, Ardrossan (*Vice-President*).
HORATIO S. CARSLAW, M.A., D.Sc., Lecturer in Mathematics, University, Glasgow.

- 20 CHARLES CHREE, M.A., D.Sc., F.R.S., 25 Mount Ararat Road, Richmond, Surrey.
 GEORGE CHRYSTAL, M.A., LL.D., F.R.S.E., Professor of Mathematics, University, Edinburgh (*Hon. Member*).
 J. B. CLARK, M.A., F.R.S.E., George Heriot's School, Edinburgh.
 S. H. COWAN, R.E., Morebattle, Kelso.
 G. E. CRAWFORD, M.A., Wykeham House, Manilla Road, Clifton, Bristol.
- 25 LAWRENCE CRAWFORD, M.A., D.Sc., Professor of Mathematics, South African College, Cape Town.
 G. A. DAVIES, Edinburgh.
 R. F. DAVIS, M.A., 447 High Road, Chiswick, London.
 J. D. HAMILTON DICKSON, M.A., F.R.S.E., Peterhouse, Cambridge.
 J. MACALISTER DODDS, M.A., Peterhouse, Cambridge.
- 30 CHAS. S. DOUGALL, M.A., High School, Newton Stewart.
 JOHN DOUGALL, M.A., Kippen, Stirlingshire.
 DAVID DRYSDALE, M.A., George Heriot's School, Edinburgh.
 GEORGE DUTHIE, M.A., F.R.S.E., The Academy, Edinburgh.
 JAMSHEDJI EDALJI, Professor, Gujarat College, Ahmedabad.
- 35 GEORGE EDNIE, M.A., B.Sc., Allan Glen's School, Glasgow.
 ALEX. EDWARD, M.A., Harris Academy, Dundee.
 ARCH. C. ELLIOT, D.Sc., C.E., Professor of Engineering, University College, Cardiff.
 R. M. FERGUSON, Ph.D., LL.D., F.R.S.E., 3 Learmonth Terrace, Edinburgh.
 JAMES FINDLAY, 4 Craiglea Drive, Edinburgh.
- 40 MARGARET FORREST, 1 Magdala Crescent, Edinburgh.
 Rev. NORMAN FRASER, B.D., Saffronhall Manse, Hamilton.
 E. P. FREDERICK, M.A., Routenburn School, Largs, Ayrshire.
 GEORGE A. GIBSON, M.A., F.R.S.E., Professor of Mathematics, Glasgow and West of Scotland Technical College, Glasgow.
 JAMES GOODWILLIE, M.A., B.Sc., Liberton, Edinburgh.
- 45 W. J. GREENSTREET, M.A., Headmaster, Marling School, Stroud.
 RODOLPHO GUIMARÃES, 55 Rue Nova da Piedade, Lisbõa, Portugal.
 P. S. HARDIE, M.A., B.Sc., Sharp's Institution, Perth.
 R. P. HARDIE, M.A., Assistant to the Professor of Logic, University, Edinburgh.
 WILLIAM HARVEY, B.A., LL.B., 53 Castle Street, Edinburgh.

- 50 DAVID H. HENDERSON, Vice-Principal, Boys' School, Kimberley, Cape Colony.
 ALEX. HOLM, M.A., Girls' High School, Glasgow.
 JAMES HORNE, M.A., George Watson's College, Edinburgh.
 JOHN JACK, M.A., Professor of Mathematics, Wilson College, Bombay.
 Rev. FRANK H. JACKSON, M.A., R.N., Chaplain and Naval Instructor, H.M.S. Dido, Mediterranean.
- 55 LORD KELVIN, LL.D., D.C.L., F.R.S., F.R.S.E., etc., Glasgow (*Hon. Member*).
 JOHN W. KIPPEN, Blackness Public School, Dundee.
 CARGILL G. KNOTT, D.Sc., F.R.S.E., Lecturer on Applied Mathematics, University, Edinburgh (*Co-Editor of Proceedings*).
 DANIEL LAMONT, M.A., F.C. Training College, Lynedoch Street, Glasgow.
 P. R. SCOTT LANG, M.A., B.Sc., F.R.S.E., Professor of Mathematics, University, St Andrews.
- 60 GEORGE LAWSON, M.A., George Watson's College, Edinburgh.
 ROBERT LEES, M.A., B.Sc., George Watson's College, Edinburgh.
 WM. A. LINDSAY, M.A., Free Church Training College, Cowcaddens, Glasgow (*Co-Editor of Proceedings*).
 J. BARRIE LOW, M.A., Wrenschtown House, Observatory Road, Cape Town.
 E. O. LOVETT, Professor of Mathematics, Princeton University, New Jersey, U.S.A.
- 65 JOHN M'COWAN, M.A., D.Sc., University College, Dundee.
 JAS. M'CUBBIN, B.A., F.R.S.E., Rector, The Academy, Kilsyth.
 WM. M'UTCHEON, B.Sc., Symington, Kilmarnock.
 JAS. A. MACDONALD, M.A., B.Sc., F.R.S.E., Rector, The Academy, Leith.
 JOHN MACDONALD, M.A., B.Sc., Ph.D., Rector, High School, Dunfermline.
- 70 W. J. MACDONALD, M.A., F.R.S.E., Daniel Stewart's College, The Dean, Edinburgh.
 D. C. McINTOSH, M.A., Ladies' College, Queen Street, Edinburgh (*Honorary Secretary*).
 Rev. JOHN MACK, B.D., Douglas Cottage, Baillieston, Glasgow.
 ALEX. C. MACKAY, M.A., B.Sc., Rector, High School, Falkirk.
 J. S. MACKAY, M.A., LL.D., F.R.S.E., The Academy, Edinburgh (*Hon. Member*).

- 75 Rev. JOHN MACKENZIE, M.A., Professor, F.C. College, Madras.
 P. MACKINLAY, M.A., Rector, Church of Scotland Training
 College, Edinburgh.
 ANGUS M'LEAN, B.Sc., C.E., Principal, Technical College, Paisley.
 DONALD MACMILLAN, M.A., Clifton Bank School, St Andrews.
 J. CHRYSAL MACMILLAN, M.A., B.Sc., Corstorphine Hill House,
 Edinburgh.
- 80 ARTEMAS MARTIN, M.A., Ph.D., LL.D., U.S. Coast Survey
 Office, Washington, D.C., U.S.A.
 J. B. MEIKLEJOHN, M.A., High School, Dundee.
 JOHN MILLAR, M.A., West of Scotland Technical College,
 Glasgow.
 W. J. MILLAR, C.E., late Secretary, Instit. Engineers and Ship-
 builders in Scotland, 31 Marine Place, Rothesay.
 T. HUGH MILLER, M.A., Training College, Isleworth, near
 London.
- 85 ARCHIBALD MILNE, M.A., 5 Elgin Terrace, Edinburgh.
 A. C. MITCHELL, D.Sc., F.R.S.E., Principal, Maharajah's
 College, Trevandrum, Travancore, India.
 HUGH MITCHELL, High Losset Farm, Machrihanish.
 JAS. MITCHELL, M.A., B.Sc., Waid Academy, Anstruther.
 JAS. MITCHELL, M.A., Headmaster, Public School, Burntisland.
- 90 GEORGE L. MOFFAT, M.A., The Academy, Glasgow.
 ALEXANDER MORGAN, M.A., D.Sc., F.R.S.E., Church of Scotland
 Training College, Edinburgh.
 J. T. MORRISON, M.A., B.Sc., F.R.S.E., Professor of Physics,
 Stellenbosch, Cape Colony.
 THOMAS MUIR, M.A., LL.D., F.R.S.E., Director-General of
 Education for Cape Colony, Cape Town.
 R. FRANKLIN MUIRHEAD, M.A., B.Sc., 24 Kerrsland Street,
 Hillhead, Glasgow (*President*).
- 95 ASUTOSH MUKHOPADHYAY, M.A., LL.D., F.R.A.S., F.R.S.E.,
 Professor of Mathematics, Bhowanipore, Calcutta.
 CHARLES NIVEN, M.A., D.Sc., F.R.S., Professor of Natural
 Philosophy, University, Aberdeen (*Hon. Member*).
 THOMAS NISBET, M.A., 4 Nisbet Street, Parkhead, Glasgow.
 F. GRANT OGILVIE, M.A., B.Sc., F.R.S.E., Principal, Heriot-
 Watt College, Edinburgh.
 R. T. OMOND, F.R.S.E., 1 Newbattle Terrace, Edinburgh.
- 100 JOHN T. PEACE, B.A., Science College, Leith.

- WILLIAM PEDDIE, D.Sc., F.R.S.E., Lecturer on Natural Philosophy, University, Edinburgh.
- DAVID L. PHEASE, M.A., Rector, Miller Institution, Thurso.
- WM. EDWARD PHILIP, M.A., The University, Glasgow.
- ROBERT PHILP, M.A., Hutcheson's Grammar School, Glasgow.
- 105 PETER PINKERTON, M.A., Royal Academical Institution, Belfast.
- R. H. PINKERTON, M.A., University College, Cardiff.
- Rev. GEORGE PIRIE, M.A., LL.D., Professor of Mathematics, University, Aberdeen.
- A. J. PRESSLAND, M.A., F.R.S.E., The Academy, Edinburgh.
- J. R. PULLAR, M.A., The Academy, Montrose.
- 110 HARRY RAINY, M.A., M.D., F.R.S.E., 25 George Square, Edinburgh.
- THOS. T. RANKIN, C.E., B.Sc., Principal, Technical School and Mining College, Coatbridge.
- DAVID RENNET, LL.D., 12 Golden Square, Aberdeen.
- JAMES RENNIE, B.Sc., Gordon's College, Aberdeen.
- WILLIAM RITCHIE, F.R.A.S., City Observatory, Calton Hill, Edinburgh.
- 115 ROBT. ROBERTSON, M.A., F.R.S.E., Headmaster, Ladies' College, Queen Street, Edinburgh.
- ALEX. D. RUSSELL, B.Sc., High School, Falkirk.
- A. RITCHIE SCOTT, B.Sc., The Academy, Alloa.
- CHARLOTTE ANGAS SCOTT, D.Sc., Professor of Mathematics, Bryn Mawr College, Pennsylvania, U.S.A.
- R. F. SCOTT, M.A., St John's College, Cambridge.
- 120 ALEX. SHAND, Natural Philosophy Laboratory, University, Edinburgh.
- ROBERT T. SKINNER, M.A., Headmaster, Donaldson's Hospital, Edinburgh.
- EDWARD SMART, B.A., B.Sc., The Academy, Perth.
- E. JOHNSTON SMITH, M.A., Royal High School, Edinburgh.
- FRANK SPENCE, M.A., B.Sc., F.R.S.E., Free Church Training College, Edinburgh.
- 125 T. B. SPAGUE, M.A., LL.D., F.R.S.E., 29 Buckingham Terrace, Edinburgh.
- J. E. A. STEGGALL, M.A., Professor of Mathematics, University College, Dundee.
- ADAM B. STEWART, M.A., School of Agriculture, Ghizeh, Cairo, Egypt.

- J. B. SIMPSON STORREY, Queen's Service College, 61 Chancery Lane, London.
- WALTER STOTT, 4 Grasmere Drive, Sea View Road, Liscard.
- 130 JAMES STRACHAN, M.A., 137 Warrender Park Rd., Edinburgh.
P. G. TAIT, M.A., D.Sc., Sec. R.S.E., Professor of Natural Philosophy, University, Edinburgh (*Hon. Member*).
JAMES TAYLOR, M.A., F.R.S.E., The Academy, Edinburgh.
W. S. TEMPLETON, M.A., B.Sc., Allan Glen's School, Glasgow.
J. A. THIRD, M.A., D.Sc., Spier's School, Beith.
- 135 GEORGE THOM, M.A., LL.D., The Institution, Dollar.
ANDREW THOMSON, M.A., D.Sc., F.R.S.E., The Academy, Perth.
WM. THOMSON, M.A., B.Sc., F.R.S.E., Registrar to the Cape University, Cape Colony.
W. L. THOMSON, M.A., George Heriot's School, Edinburgh.
ROBERT TUCKER, M.A., Hon. Sec. London Mathematical Society, 24 Hillmarton Road, London, N.
- 140 JOHN TURNER, M.A., B.Sc., Royal High School, Edinburgh.
CHARLES TWEEDIE, M.A., B.Sc., F.R.S.E., Lecturer in Mathematics, University, Edinburgh (*Co-Editor of Proceedings*).
DAVID TWEEDIE, M.A., B.Sc., Ras-el-Tin Government School, Alexandria, Egypt.
SAMUEL WALKER, M.A., B.Sc., George Heriot's School, Edinburgh.
A. G. WALLACE, M.A., Headmaster, Central Public School, Aberdeen.
- 145 W. WALLACE, M.A., F.R.S.E., Principal, Southern Higher Grade School, Leeds.
W. G. WALTON, F.F.A., Scottish Provident Office, 6 St Andrew Square, Edinburgh.
T. P. WATSON, M.A., B.Sc., F.R.S.E., George Watson's College, Edinburgh.
JOHN C. WATT, M.A., Jesus College, Cambridge.
JAMES MACPHERSON WATTIE, M.A., B.A., H.M.I.S., Earlsmount, Fife-Keith, Banffshire.
- 150 JOHN WEIR, M.A., Professor of Mathematics, Mysore, India.
WILLIAM WELSH, M.A., Jesus College, Cambridge.
JOHN W. WHITE, Lorne Street Public School, Leith.
WILLIAM WYPER, C.E., 10 Highburgh Terrace, Dowanhill, Glasgow.
W. YOUNG, F.F.A., 19 George Street, Edinburgh.

The following Presents to the Library have been received, for which the Society tenders its grateful thanks.

1. **Proceedings of the London Mathematical Society.**
Vol. xxx.—Nos. 672-702.
Vol. xxxi.—Nos. 703-709.
2. **Memoirs and Proceedings of the Manchester Literary and Philosophical Society.**
Vol. xliii.—Parts 4-5.
Vol. xliv.—Parts 1-3.
3. **Proceedings of the Cambridge Philosophical Society.**
Vol. x.—Parts 3-4.
4. **Bulletin of the American Mathematical Society.**
Second Series—Vol. v.—Nos. 9-10. Vol. vi.—Nos. 1-9.
5. **American Journal of Mathematics.** Published under the auspices of the Johns Hopkins University.
Vol. xx.—No. 3. Vol. xxi.—Nos. 1-2. Vol. xxii.—Nos. 1-2.
6. **Transactions of the American Mathematical Society.**
Vol. i. No. 1.
7. **Annals of Mathematics.** Published under the auspices of the University of Virginia.
Vol. xii.—No. 6. Vol. i. of Second Series. Nos. 1-3.
8. **Proceedings of the American Philosophical Society (Philadelphia).**
Vol. xxxviii.—No. 159.
9. **The Kansas University Quarterly.**
Vol. viii.—Nos. 2-3 (Series A).
10. **Mathematical Gazette.** Nos. 19-22.
11. **Annales de la Faculté des Sciences de Marseille.**
Tome x.—Fasc. 1-6.
12. **Bulletin de la Société Mathématique de France.**
Vol. xxvii.—Nos. 2-4.
Vol. xxviii.—Nos. 1-2.

13. **Journal de Mathématiques Élémentaires.**
Publié par M. H. VUIBERT.
Nos. 1-19. 1899-1900.
14. **Journal de Mathématiques Élémentaires.**
Publié sous la direction de M. GEORGES MARIAUD.
Nos. 10-11—1898-99. Nos. 1-9—1899-1900.
15. **Journal de Mathématiques Spéciales.**
Publié sous la direction de M. GEORGES MARIAUD.
Nos. 10-12—1898-99. Nos. 1-9—1899-1900.
16. **Il Pitagora, Gioronale di Matematica.**
Anno 6. Nos. 1-8.
17. **Mathematisch-naturwissenschaftliche Mitteilungen im Auftrag des
mathematisch-naturwissenschaftlichen Vereins in Württemberg.**
Zweite Serie. Zweiter Band. Zweites Heft.
18. **Revue Semestrielle des Publications Mathématiques. Published
under the auspices of the Mathematical Society of Amsterdam.**
Vol. VIII.—Part 1.
19. **New Laboratorum et Museum.** Berlin. 1900. Nos. 1-2.
20. **Mémoires de la Société Royale des Sciences de Liège.**
Second Series. Tom. I.
21. **Nieuw Archief voor Wiskunde.**
Tweede Reeks.—Deel IV., 2-3.
22. **Jornal de Sciencias Mathematicas e Astronomicas.**
Publicado pelo Dr F. GOMES TEIXEIRA.
Vol. XIII.—No. 6.
Vol. XIV.—No. 1.
23. **Rendiconti del Circolo Mathematico di Palermo.**
Tomo XIV.—Fasc. 1-4.
24. **Bulletino dell' Associazione " Mathesis " fra gl'insegnanti di Matema-
tica delle Scuole Medie.**
Nos. 1-6. 1899-1900.
25. **Multihomogeneous Theorem by Moromoto Nishi, Tokyo, Japan.**
26. **Communications de la Société Mathématique de Kharkow.**
Vol. VI.—No. 5 and 6. (Second Series).

Fig. 1.

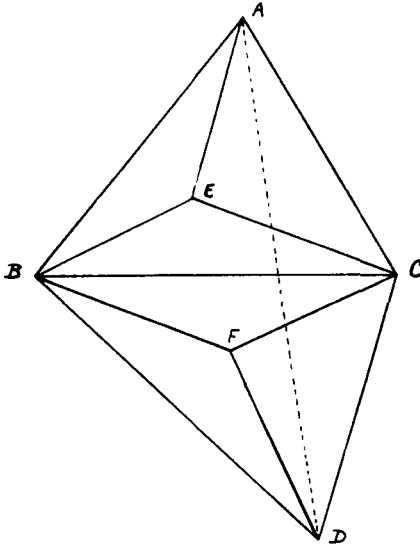

Fig. 2.

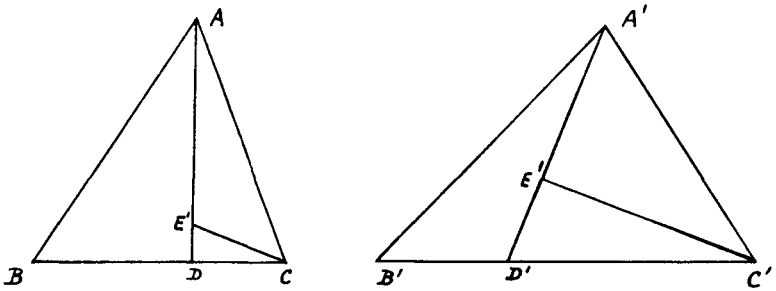

Fig. 3.

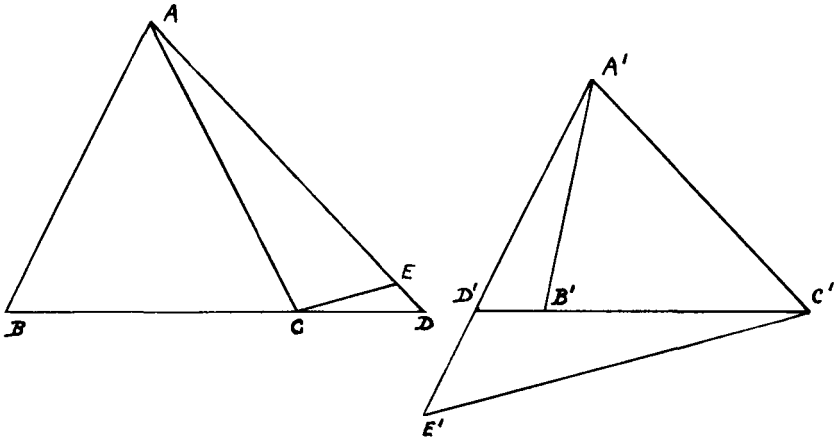

Fig. 4.

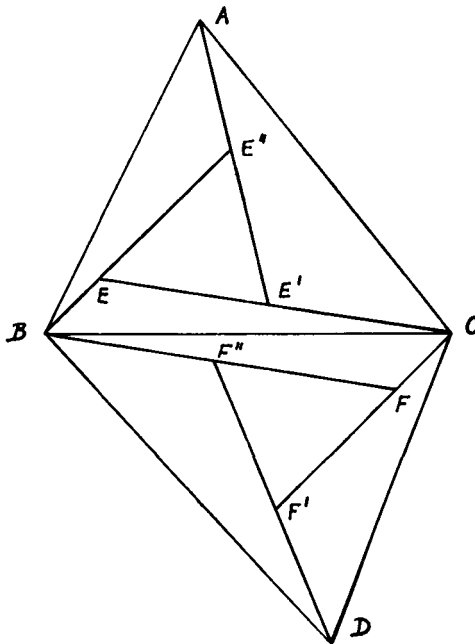

Fig. 4

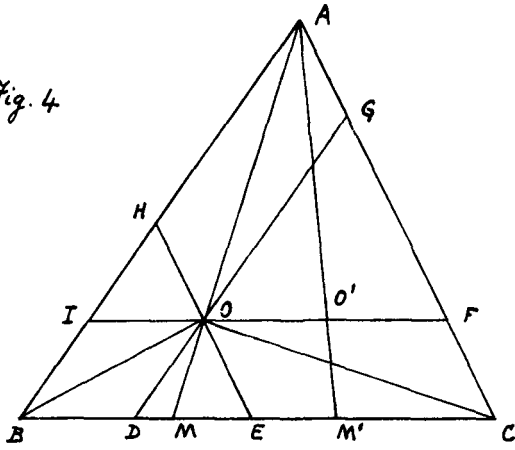

Fig. 5

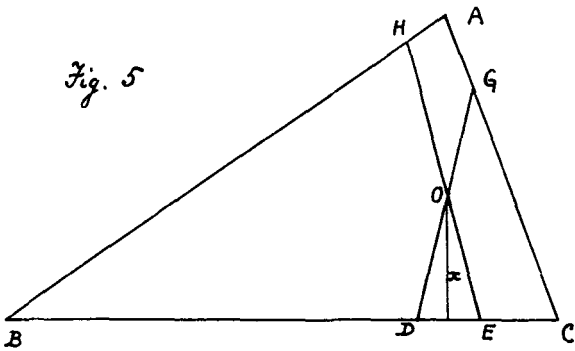

Fig. 6

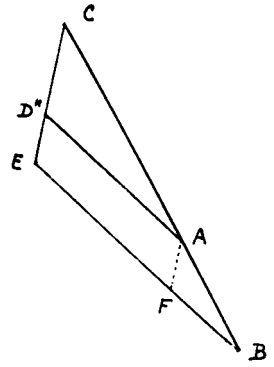
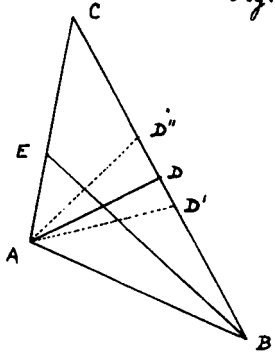
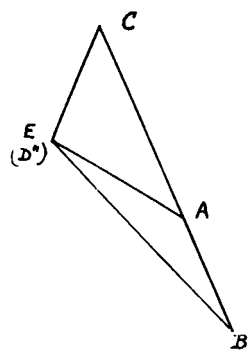
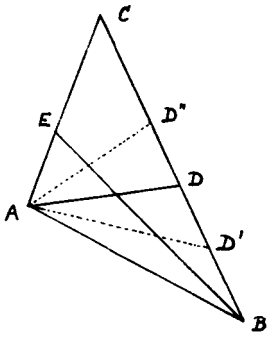

Fig. 7



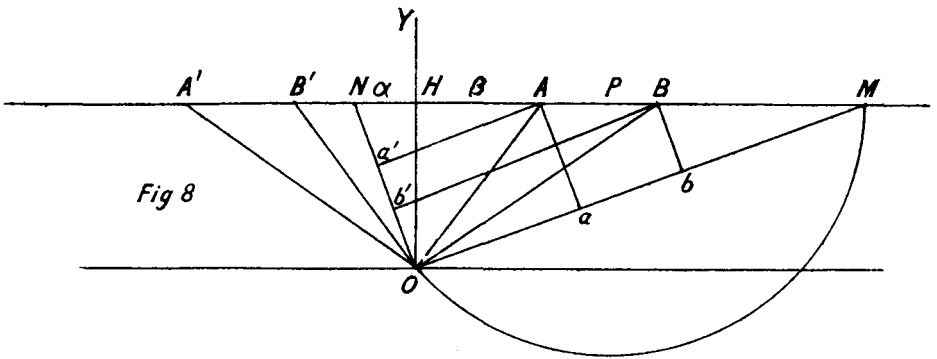

Fig 8

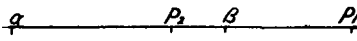

Fig 9

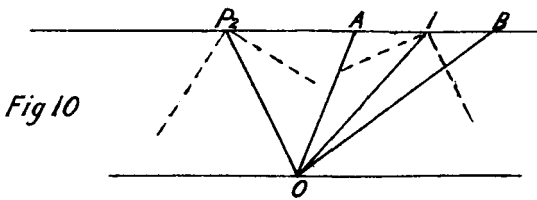

Fig 10

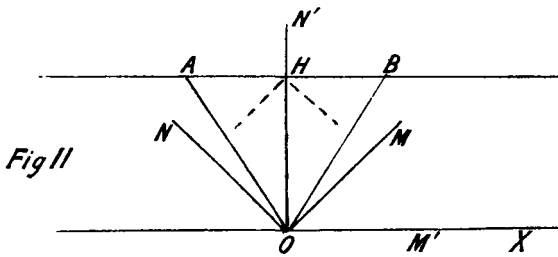

Fig 11

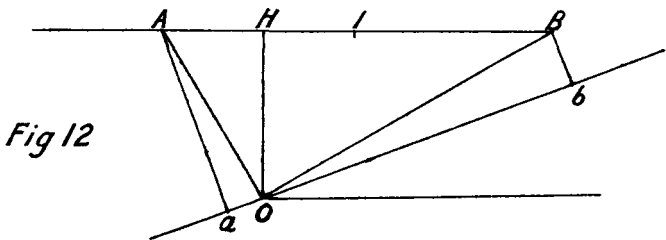

Fig 12

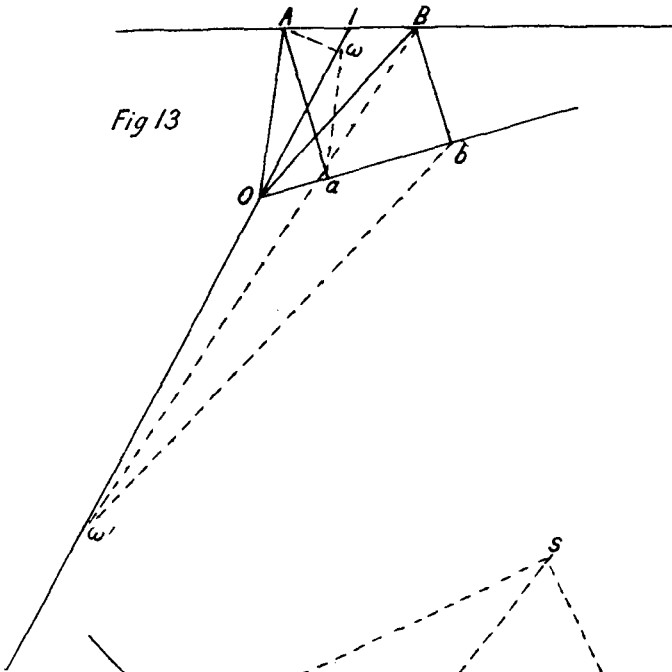

Fig 13

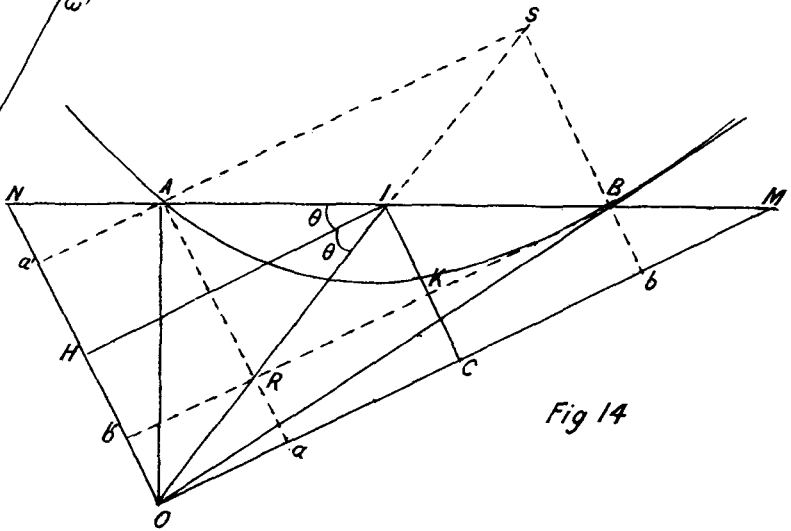

Fig 14

Fig. 13.

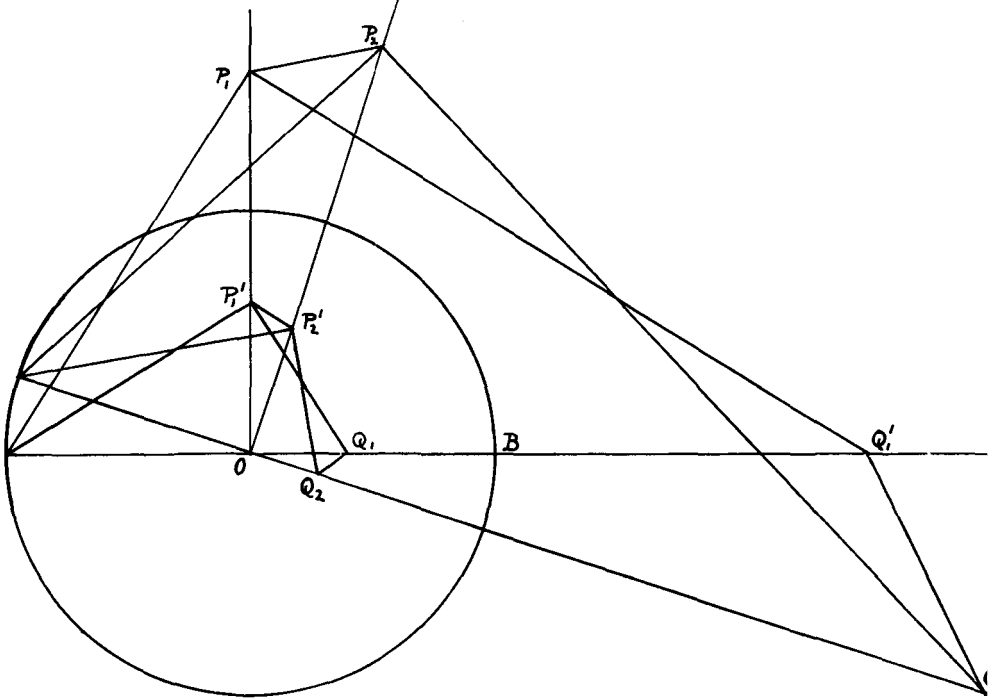

Fig. 14.

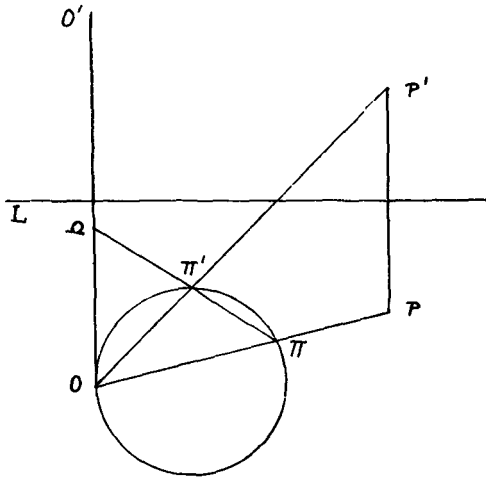

Fig. 15.

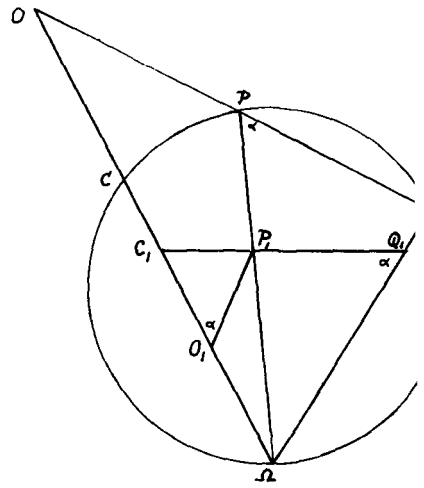

Fig. 16.

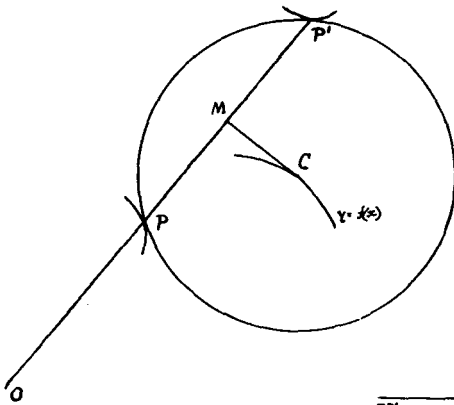

Fig. 17.

