

3 The power of mathematics

JOHN CONWAY

This is a lecture about the power of simple ideas in mathematics.

What I like doing is taking something that other people thought was complicated and difficult to understand, and finding a simple idea, so that any fool – and, in this case, you – can understand the complicated thing.

These simple ideas can be astonishingly powerful, and they are also astonishingly difficult to find. Many times it has taken a century or more for someone to have the simple idea; in fact it has often taken 2000 years, because often the Greeks could have had that idea, and they didn't.

People often have the misconception that what someone like Einstein did is complicated. No, the truly earth-shattering ideas are simple ones. But these ideas often have a subtlety of some sort, which stops people from thinking of them. The simple idea involves a question nobody had thought of asking.

Consider, for example, the question of whether the Earth is a sphere or a plane. Did the ancients sit down and think 'now let's see – which is it, a sphere or a plane?'" No, I think the true situation was that no-one could *conceive* the idea that the earth was spherical – until someone, noticing that the stars seemed to go down in the West and then twelve hours later come up in the East, had the idea that everything might be *going round* – which is difficult to reconcile with the accepted idea of a flat earth.

Another funny idea is the idea of 'up'. Is 'up' an absolute concept? It was, in Aristotelian physics. Only in Newtonian physics was it realised that 'up' is a local concept – that one person's 'up' can be another person's 'down' (if the first is in Cambridge and the second is in Australia, say). Einstein's discovery of relativity depended on a similar realisation about the nature of time: that one person's time can be another person's sideways.

Power, edited by Alan Blackwell and David MacKay. Published by Cambridge University Press.
© Darwin College 2005.

Well, let's get back to basics. I'd like to take you through some simple ideas relating to squares, to triangles, and to knots.

Squares

Let's start with a new proof of an old theorem. The question is: 'is the diagonal of a square commensurable with the side?' Or to put it in modern terminology: 'Is the square root of 2 a ratio of two whole numbers?' This question led to a great discovery, credited to the Pythagoreans, the discovery of irrational numbers.

Let's put the question another way. Could there be two squares with sides equal to a whole number, n , whose total area is identical to that of a single square with sides equal to another whole number, m ?

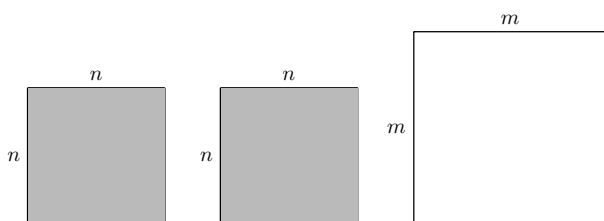

FIGURE 3.1 If m and n are whole numbers, can the two grey $n \times n$ squares have the same area as the white $m \times m$ square?

This damn nearly happens for 12 by 12 squares: 12 times 12 is 144; and 144 plus 144 equals 288, which does not *actually* equal 289, which is 17 times 17. So $17/12 = 1.41666\dots$ is very close to $\sqrt{2} = 1.41421\dots$ – it's only out by two parts in a thousand.

But we're not asking whether you can find whole numbers m and n that *roughly* satisfy $m^2 = 2n^2$. We want to establish whether it can be done *exactly*.

Well, let's assume that it *can* be done. Then there must be a *smallest* whole number m for which it can be done. Let's draw a picture using that smallest possible m .

Let's stick the two small grey squares in the top right and bottom left corners of the big square.

Now, part of the big square is covered twice, and part of the big square isn't covered at all, by the smaller squares. The part that's covered twice is shown in dark grey, and the bits that are not covered are shown in white. Since the

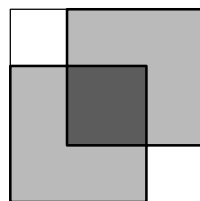

area of the original big white square is exactly equal to the total area of the light grey squares, the area of the bit that's covered twice must be exactly equal to the area of the bits that are not covered.

Now, what are the sizes of these three areas? The dark grey bit is a square, and the size of that square is a whole number, equal to $2n - m$; and the two white areas are also squares, with sides equal to $m - n$. So, starting from the alleged smallest possible whole number m , such that m^2 is twice the square of a whole number, we've found that there is an even *smaller* whole number $(2n - m)$ having this property. *So there can be no smallest solution.* Remember, if there are any solutions, one of them must be the smallest. So we conclude that there are *no* solutions.

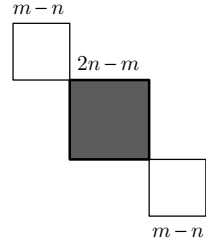

This result has tremendous intellectual consequences. Not all real numbers are the ratio of whole numbers.

This new proof was created by a friend of mine called Stanley Tennenbaum, who has since dropped out of mathematics.

Triangles

Take a triangle, any triangle you like, and trisect each of its angles. That means, cut each angle into three pieces, all the same size.

Extend the trisectors until they meet at three points.

Then a rather remarkable theorem by Frank Morley says that the triangle formed by these points is *equilateral*. And this is true for any starting triangle.

Morley's theorem is renowned as being a theorem that's really hard to prove. Very simple to state, but very hard to prove. Morley stated the result in about 1900, and the first published proof didn't come till about 15 years later. However, I found a simple proof, aided by my friend Peter Doyle. Let me show you.

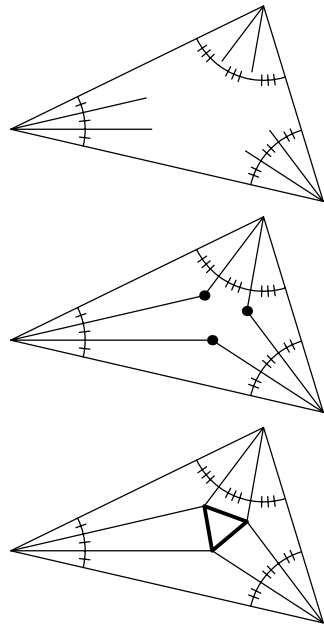

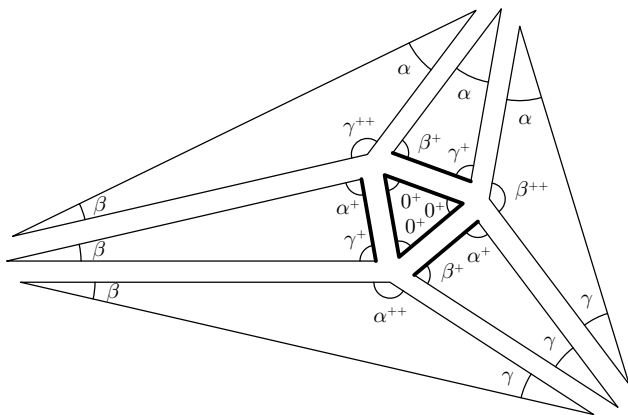

First, please tell me the three angles A, B, C , of your original triangle. Remember they have to add up to 180 degrees. Here's the plan. I'm going to *start* from an equilateral triangle of some size and build up six other triangles around it, and glue them together to create a triangle that has angles A, B , and C , just like yours; so for some choice of the size of the equilateral triangle, my construction will exactly reproduce your original triangle; furthermore the method of construction will prove that if you trisect your triangle's angles, you'll find my equilateral triangle in the middle. The diagram above shows the six triangular pieces that we will build around the equilateral triangle. This picture looks like a shattered version of the triangle we drew a moment ago, and indeed we'll in due course glue the pieces together to create that triangle; but to understand the proof correctly, you must think of the six new triangles as pieces that we are going to *define*, starting from my equilateral triangle, with the help of the values of A, B and C that you supplied. The previous page's figure is our destination, not our starting point.

We construct the six new triangles by first defining their shapes, then defining their sizes. To define the shapes of the six triangles, we fix their angles as shown in the diagram above. We define $\alpha = A/3, \beta = B/3$, and $\gamma = C/3$. We introduce a piece of notation for angles: for any angle θ , we define θ^+ to denote $\theta + 60$ and θ^{++} to denote $\theta + 120$. So, for example, the three interior angles in the equilateral triangle (which are all 60 degrees) may be marked 0^+ . (You may check that the angles in each triangle sum to 180.) Next, we fix the size of each triangle that abutts onto the equilateral triangle by making the length of one

side equal that of the equilateral. These equal sides are shown by bold lines on the first diagram.

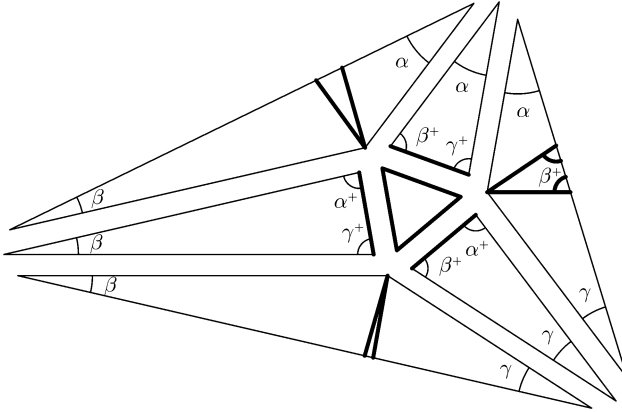

Next we fix the sizes of the three obtuse triangles; I'll show you how we fix the right-hand obtuse triangle, and you can use an analogous method to fix the other two. We introduce two lines that meet the long side at an angle of β^+ (a bit like dropping perpendiculars), and fix the size of the triangle so that both those lines have the same length as the side of the equilateral triangle.

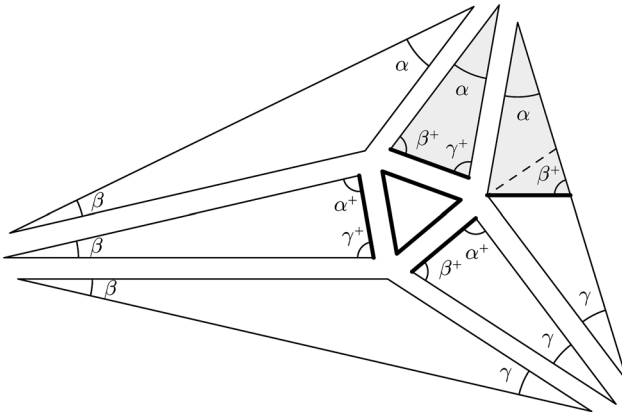

Now, having defined the sizes of all the triangles in this way, I claim that the two shaded triangles are identical – one is the mirror image of the other. We can see that this is so, because they have two identical angles (the α s and the β^+ s); and they have one identical side (the highlighted sides, which are equal

to the equilateral's side). Therefore the adjacent edges of those two triangles are identical in length.

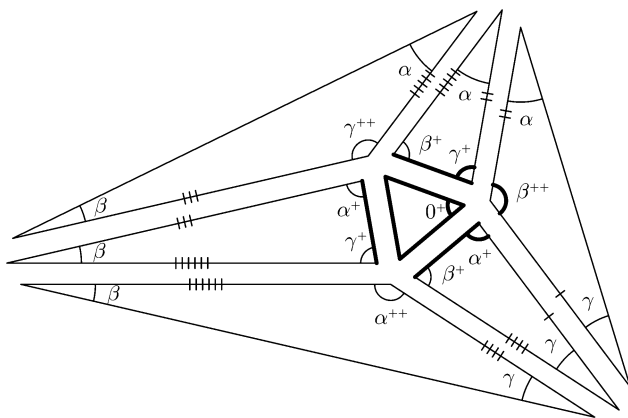

Applying the same argument six times over, we have shown that all the adjacent edges in the figure are identical to each other, and thus established that these six triangles will fit snugly around my equilateral triangle, as long as the angles around any one internal vertex sum to 360 degrees. The sum around a typical internal vertex is $\alpha^+ + \beta^{++} + \gamma^+ + 0^+$; that's five +s, which are worth 300 degrees, plus $\alpha + \beta + \gamma$, which gives a total of 360.

Thus, gluing the seven pieces together, I've made a triangle with your angles, for which Morley's theorem is true. Therefore, Morley's theorem is true for your triangle, and for any triangle you could have chosen.

Knots

Finally, I would like to tell you a little bit about knot theory, and about a simple idea I had when I was a high school kid in Liverpool many years ago.

First, what's the big deal about knots? Knots don't seem especially mathematical. Well, the first thing that's hard about knots is the question: 'Are there any?'

To put it another way, can this knot be undone? (It's conventional, by the way, to attach the two free ends of a knot to each other, so that the rope forms a closed loop.) The fact that no-one's undone it doesn't mean you necessarily can't do it. It might just mean that people are stupid. Remember, there are simple ideas that no-one had for 2000 years, then Einstein came along and had them!



Now, when we fiddle around with a piece of string, changing one configuration into another, there are three basic things that can happen. These are called the Reidemeister moves, after the German professor of geometry, Kurt Reidemeister. We'll call these moves R_1 , R_2 and R_3 .

R_1 involves twisting or untwisting a single loop, leaving everything else unchanged.

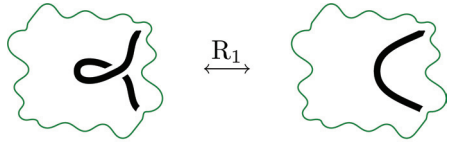

R_2 takes a loop and pokes it under an adjacent piece of rope.

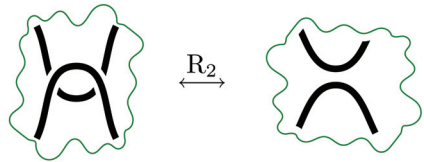

R_3 is the slide move, which passes one piece of rope across the place where two other segments cross each other.

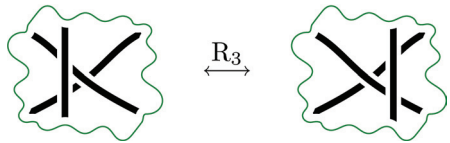

All knot deformations can be reduced to a sequence of these three moves.

Now, is there a sequence of these moves that will enable you to start with the knot on the left and end with the 'unknot' on the right? You can perhaps imagine applying a sequence of moves until it really looks rather messy – imagine a picture like this, but with maybe a million crossings in it:

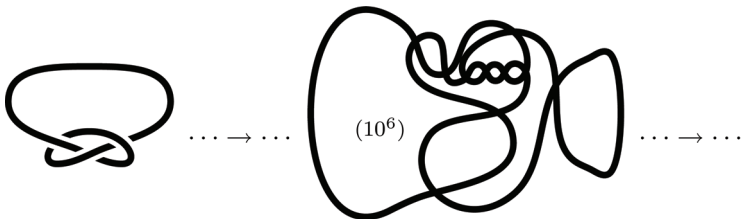
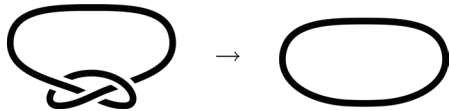

And maybe eventually, if I'm lucky, another million moves would bring me to the unknot.



Can you disprove this story?

It is quite hard to disprove it. I believe no one has ever tried going out to all the mindbogglingly large number of million-crossing configurations and checking what happens in each case. And the difficult challenge is, if we want to prove that a knot exists, we must show that *no* such sequence of moves exists.

What I'm going to do is introduce what I call a *knumbering* of knots. To make a knumbering, you assign a little number to any visible piece of string; and in a place where one piece disappears under another, the two numbers associated with the *lower* piece of string must be related to each other in a way that depends on the number on the *upper* piece of string. Namely, if the number on the upper piece is b , and the lower piece's numbers on either side of the upper piece are a and c , then ' a, b, c ' must be an *arithmetic progression*. That means the amount by which you go up from a to b has to be exactly the amount by which you go up from b to c .

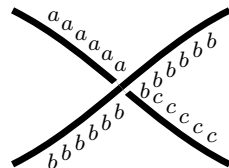

For example, if a is 13 and b is 16, then c had better be 19.

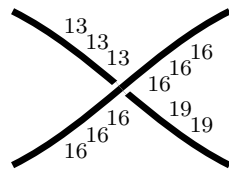

Now, what is the relevance of these numbers? Well, let's first see if we can make a knumbering. Let's take our old friend, the trefoil knot, and work our way round the knot, assigning numbers to its different segments, and see if we can satisfy the arithmetic progression condition at every crossing. How should we start? One thing worth noticing about the arithmetic progression condition is that it is *invariant*: I can shove all the numbers a, b and c up or down by any amount I like, and they will still satisfy the arithmetic progression condition. So we may as well start by assigning the labels 0 and 1 to a couple of edges here, then we can propagate the consequences of those choices around the rest of the knot. We'll mark each crossing as we apply its rule.



So far, so good. . .

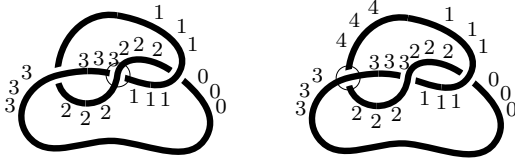

Oh dear, there is a problem on the top edge, namely that 4 isn't equal to 1, and they should be equal, because there's a 4 and a 1 both on the same piece of rope. However, one of the great powers of the mathematical method is that I can define things however I like; so I'm now going to define **4** to be **equal to 1**. (Mathematicians call this kind of equality 'congruence modulo 3'.) So, phew! I cured that problem.

There is a similar contradiction on the bottom segment: this edge is labelled both '3' and '0'. But if 4 is equal to 1, then 3 is equal to 0. So everything is all right.

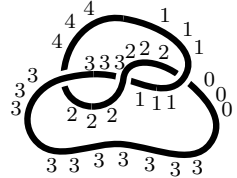

We have got a knumbering.

Now, what's the point of these knumberings? It is very beautiful. Look at what happens when we take a knumbered knot and apply the three Reidemeister moves to it. Can we take the left-hand knumbering and obtain a right-hand knumbering?

The answer is yes, any valid knumbering for the left-hand figure can be copied into a valid knumbering for the right-hand figure, and vice versa. This is quite easy to confirm for the first two moves.

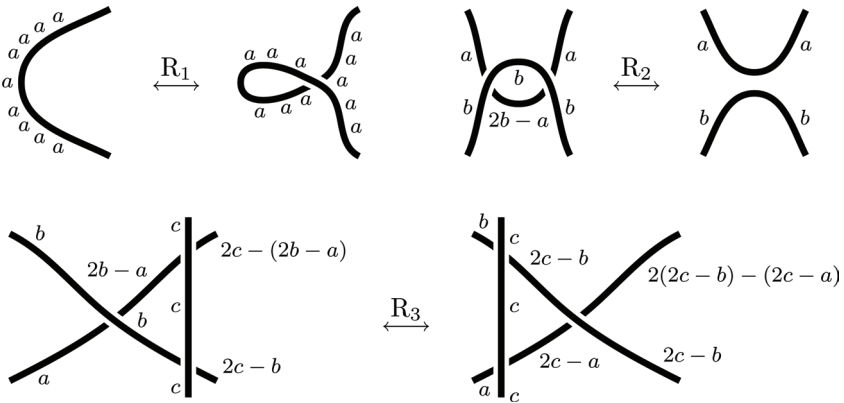

For the third move, we have to confirm that $2(2c - b) - (2c - a) = 4c - 2b - (2c - a) = 2c - (2b - a)$.

We find that we can do any of the three moves without messing up the rest of the knumbering.

The fact that any valid knumbering remains a valid knumbering when a move is made or unmade implies that the *number of possible knumberings* of the left-hand picture is exactly equal to the *number of knumberings* of the right-hand picture.

Now, let's return to the question of whether the trefoil knot can be transformed into the unknot. Well, there are just three knumberings of the unknot.

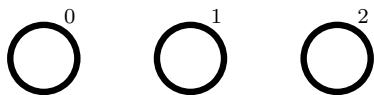

Whereas the trefoil knot has at least four knumberings: the all-0, all-1, and all-2 knumberings, *and* this one.

So now, we can prove that *the trefoil knot cannot be undone*, because it has a different number of knumberings from the unknot. If the trefoil knot and the unknot were related by a sequence of Reidemeister moves, they would have the same number of knumberings.

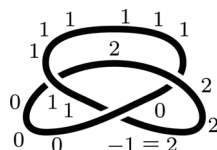

This proves that knots *do* exist.

Tangles

I often do a little conjuring trick which consists of tying knots. Tangles are bits of knottiness with four ends coming out, and they have an unexpected connection to arithmetic.

Tangles are best displayed by four square-dancers. Two dancers hold the ends of one rope, and two dancers hold the ends of the other rope. We can manipulate the tangle by using two moves, called *twist 'em up* and *turn 'em roun'*.

When we *twist 'em up*, the two dancers on the right-hand side exchange places, the lower dancer going *under* the rope of the upper dancer. Now, we're going to assert that each tangle has a value, and that 'twist 'em up' changes the value of the tangle from t to $t + 1$. (These values aren't related to knumberings; you can forget about knumberings now.)

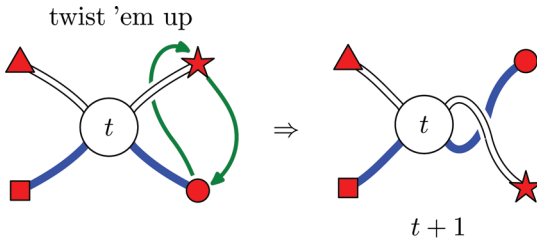

When we *turn 'em roun'*, all four dancers move one place clockwise. 'Turn 'em roun' changes the value of a tangle from t to $-1/t$.

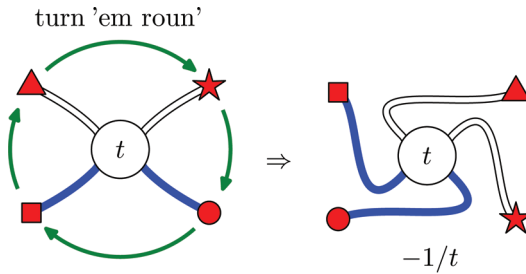

To get us started, the tangle shown below is given the value $t = 0$.

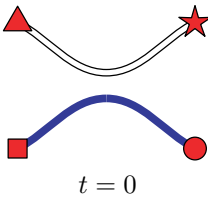

Is everything clear? Then let's go!

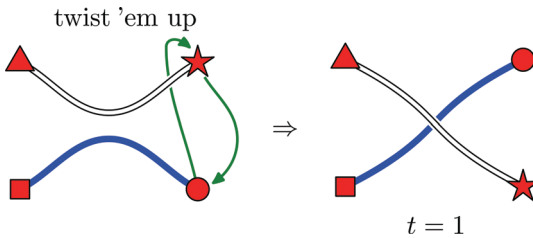

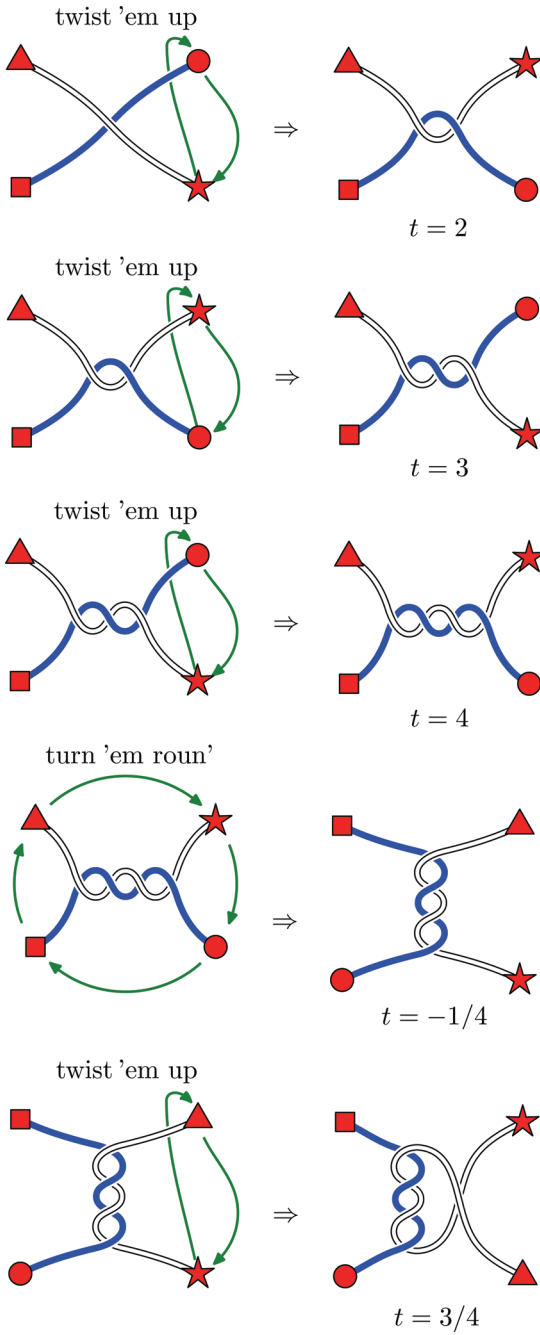

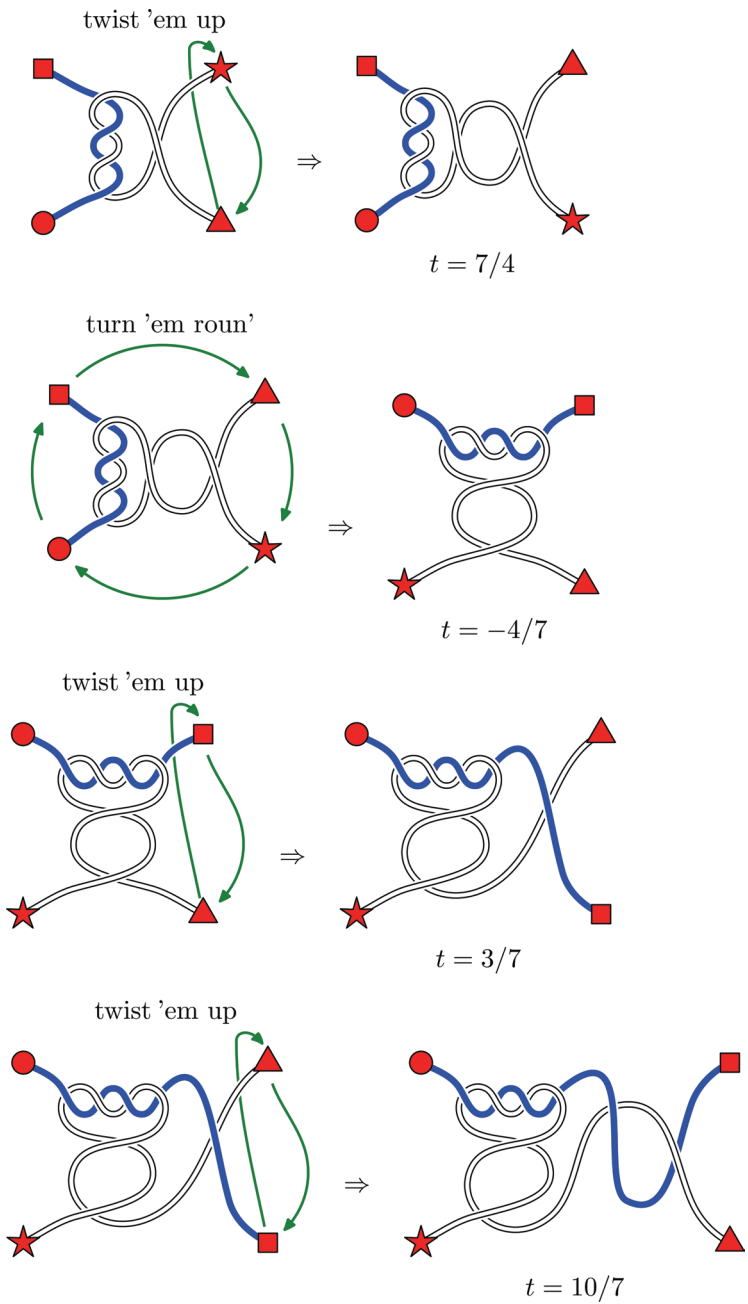

turn 'em roun'

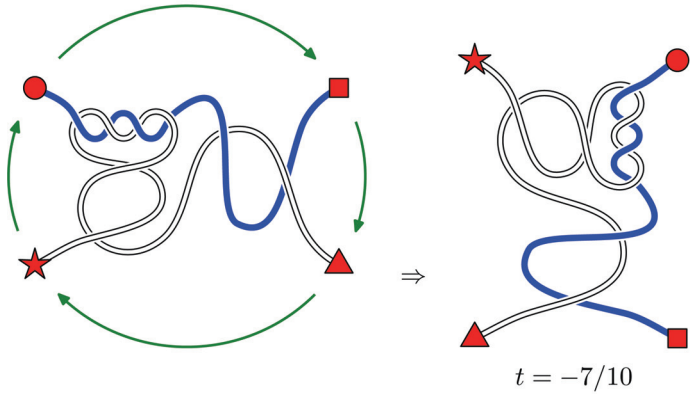

twist 'em up

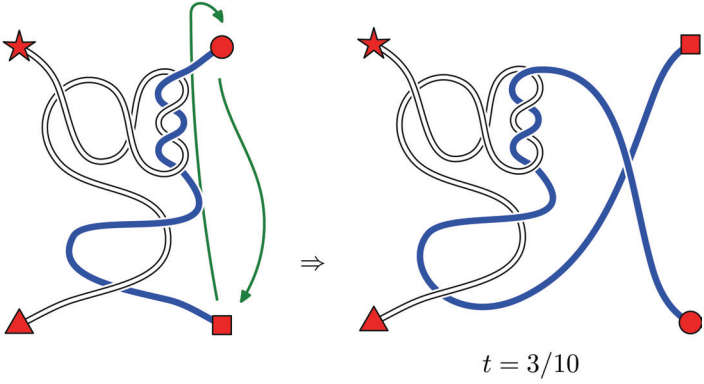

twist 'em up

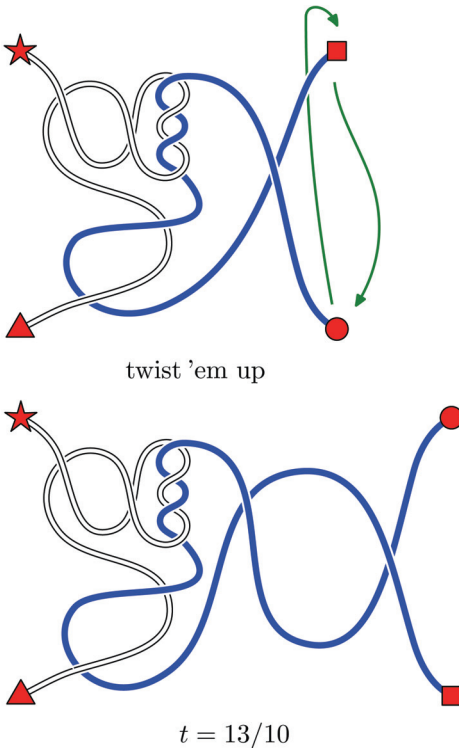

Now, it is your job, dear reader, to get the dancers back to zero. But you are only allowed to do the two moves I've spoken of. Do you want to twist or do you want to turn?

What you'll find is that if you use your knowledge of arithmetic to get the value back to zero, *the tangle will indeed become undone*. It's magic! [The sequence chosen by the audience in Cambridge was: $13/10 \xrightarrow{r} -10/13 \xrightarrow{u} 3/13 \xrightarrow{r} -13/3 \xrightarrow{u} -10/3 \xrightarrow{u} -7/3 \xrightarrow{u} -4/3 \xrightarrow{u} -1/3 \xrightarrow{r} 3 \xrightarrow{u} 4 \xrightarrow{r} -1/4 \xrightarrow{u} 3/4 \xrightarrow{r} -4/3 \xrightarrow{u} -1/3 \xrightarrow{u} 2/3 \xrightarrow{r} -3/2 \xrightarrow{u} -1/2 \xrightarrow{u} 1/2 \xrightarrow{r} -2 \xrightarrow{u} -1 \xrightarrow{u} t = 0$, with twist 'em up and turn 'em roun' abbreviated to \xrightarrow{u} and \xrightarrow{r} , respectively.]

This is an example of a very simple idea. We already knew some arithmetic – but only in the context of numbers; and we didn't realise it applies to knots. So in fact this little branch of knot theory is really just arithmetic.

Having found this unexpected connection, let's finish with something fun. Start from $t = 0$, and turn 'em roun'. What do we get?

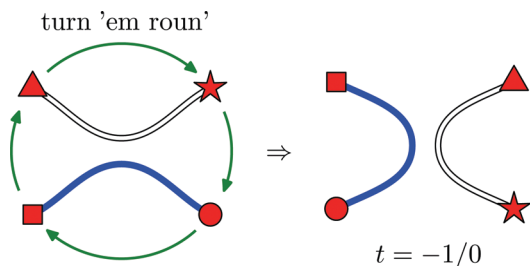

Hmm! Now we've got $-1/0$, isn't that some sort of infinity, or minus infinity?

Let's see what you get when you add one to infinity. Does adding one to infinity make any difference? Twist 'em up!

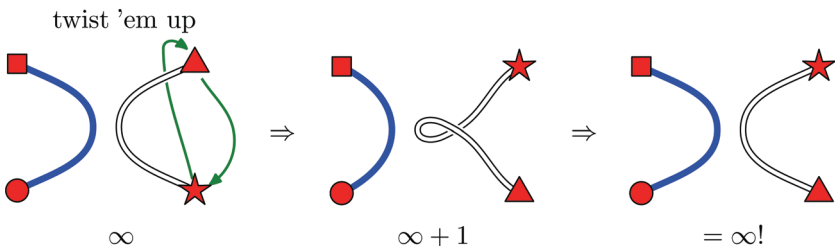

Isn't that nice? We add one to infinity, and we get infinity again.

So, this is a powerful idea that we mathematicians use: you take something you've learnt in one place, and apply it to something else, somewhere where it's not obvious that there is any mathematics, and there *is*.