

FIG. 1

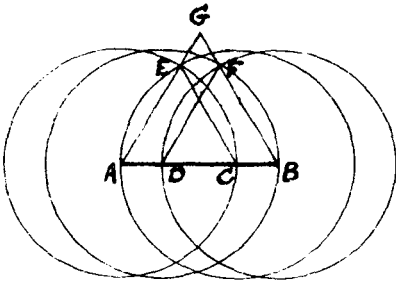

FIG. 2

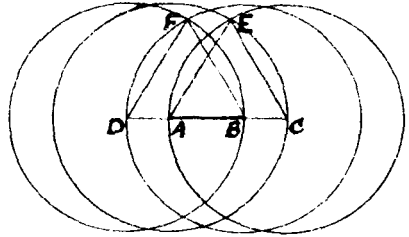

FIG. 3

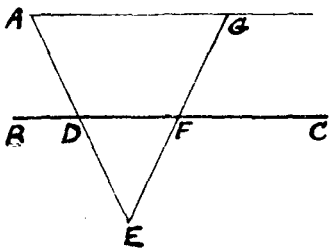

FIG. 4

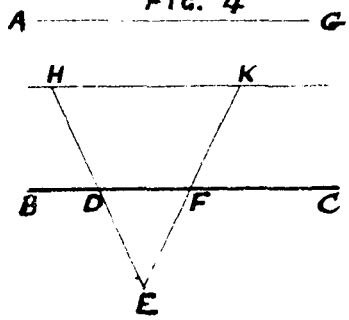

FIG. 5

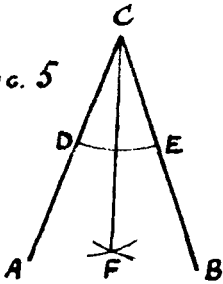

FIG. 6

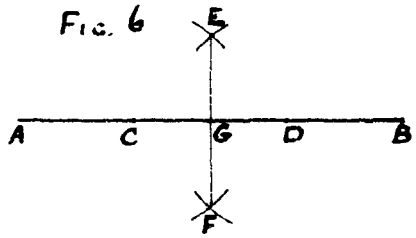

FIG. 7

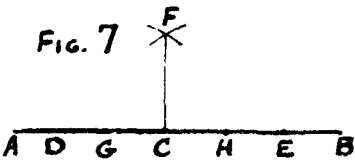
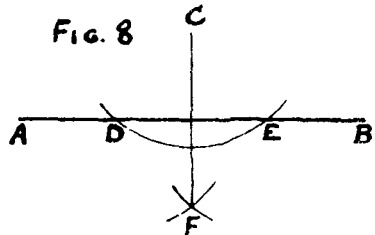
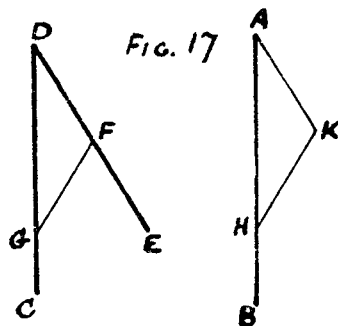
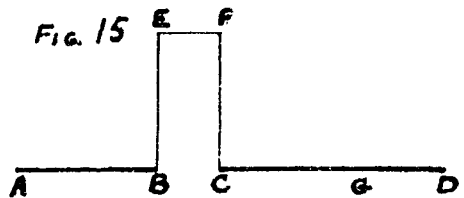
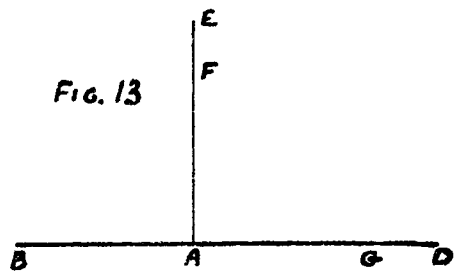
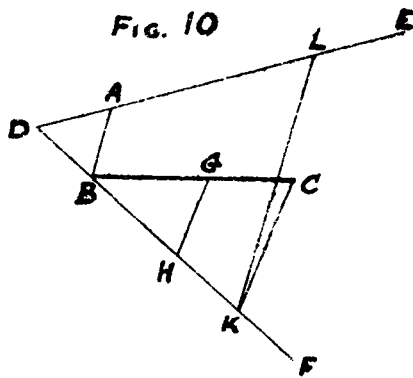
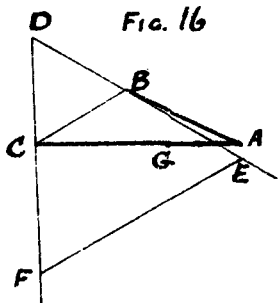
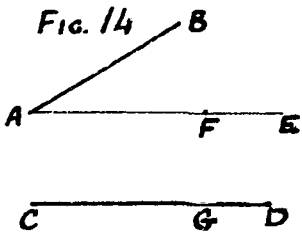
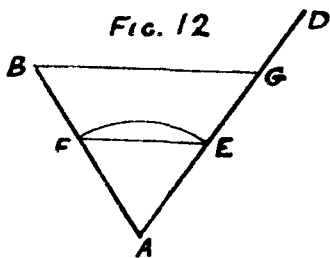
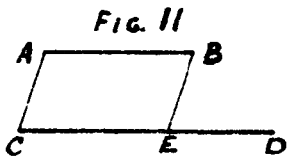
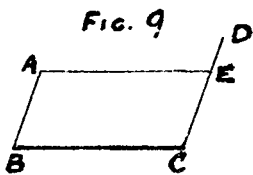

FIG. 8





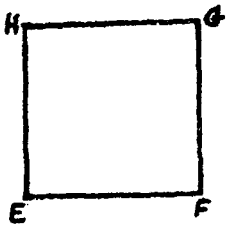

Fig. 18

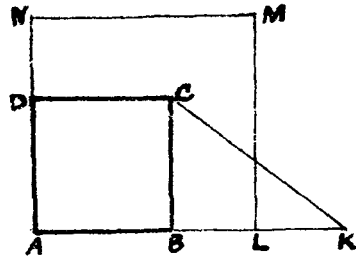

Fig. 20

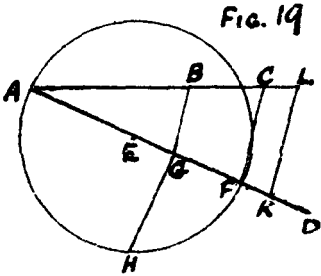

Fig. 19

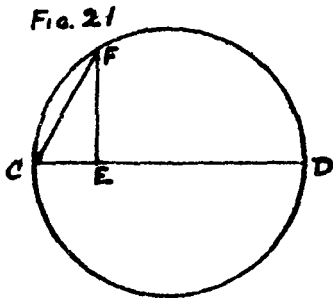
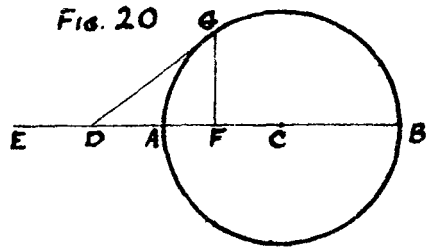

Fig. 21

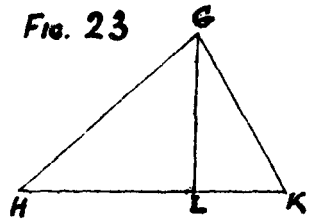

Fig. 23

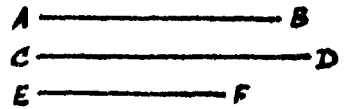
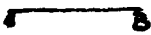
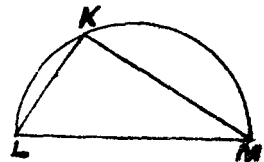
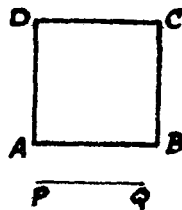
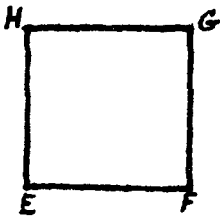

Fig. 22



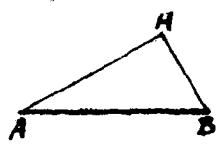
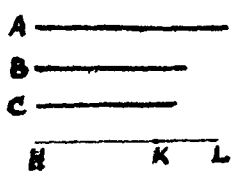
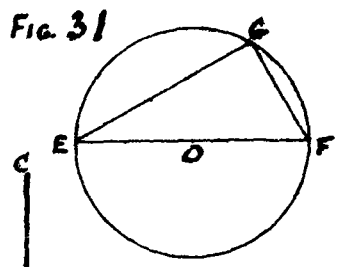
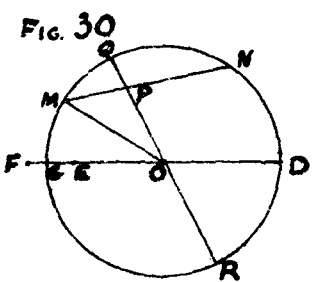
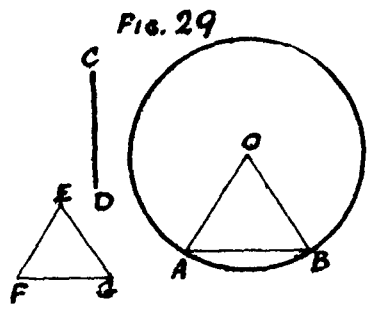
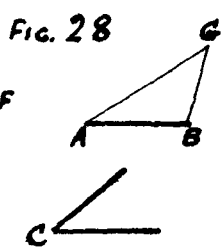
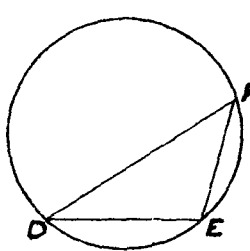
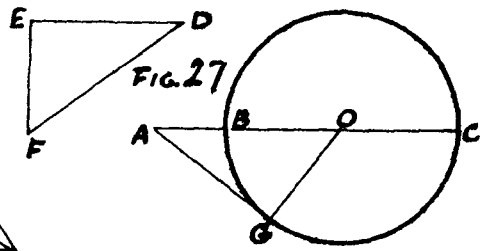
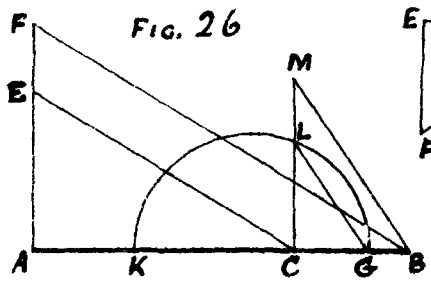
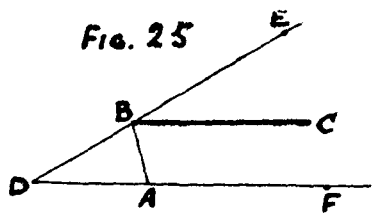
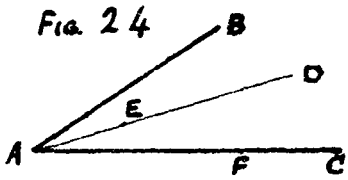

Fig. 32

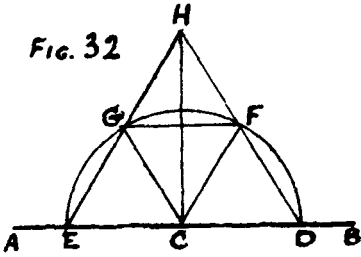

Fig. 33

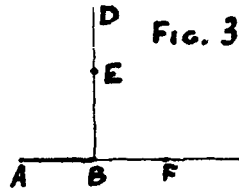

Fig. 34

Fig. 35

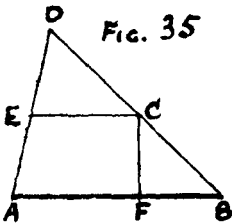

Fig. 36

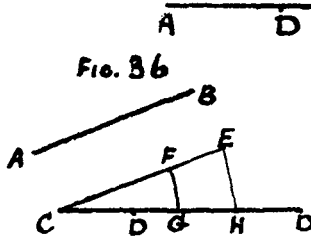

Fig. 37

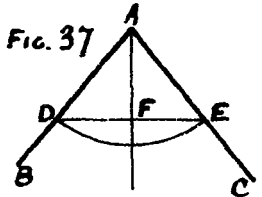

Fig. 39

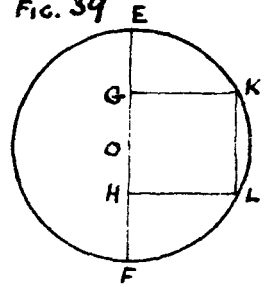

Fig. 38

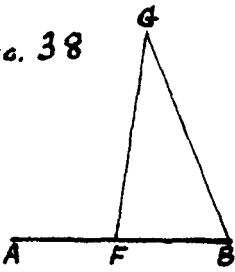
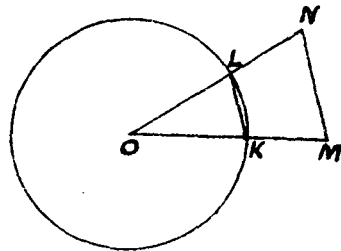
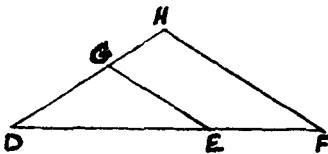
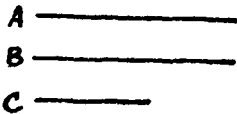

Fig. 40



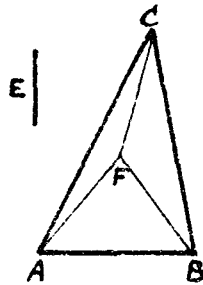
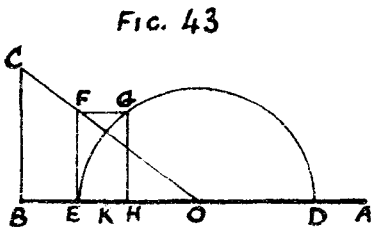
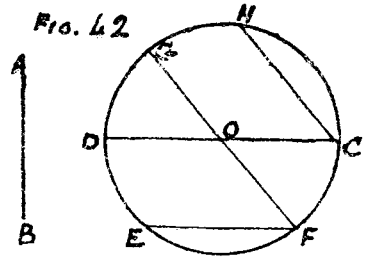
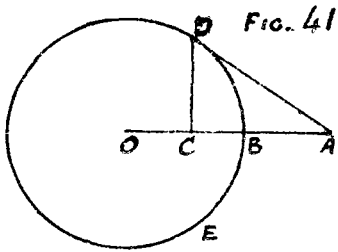

FIG. 45

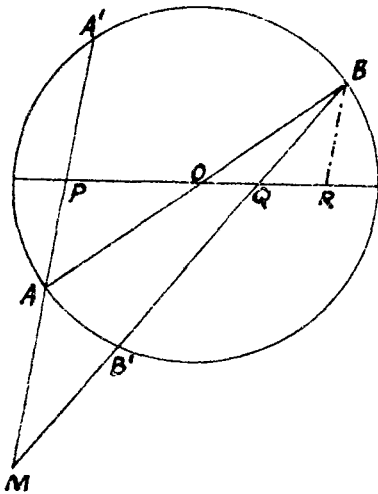

FIG. 46

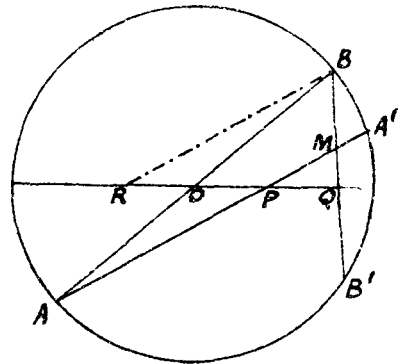

Fig. 47

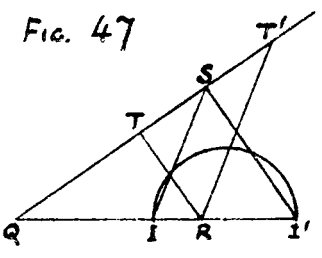

Fig. 48

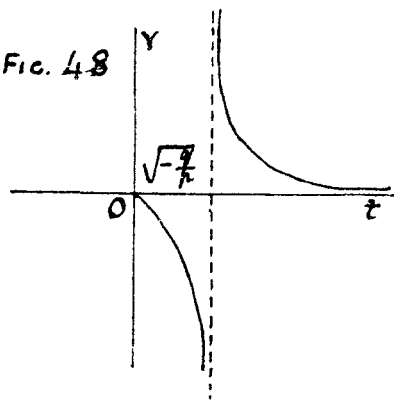

Fig. 49

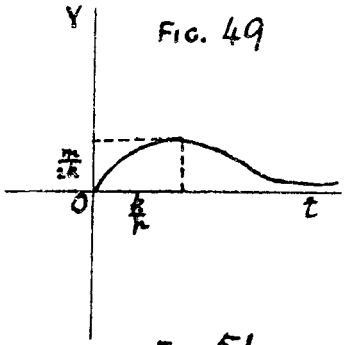

Fig. 50

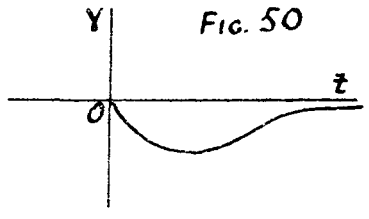

Fig. 51

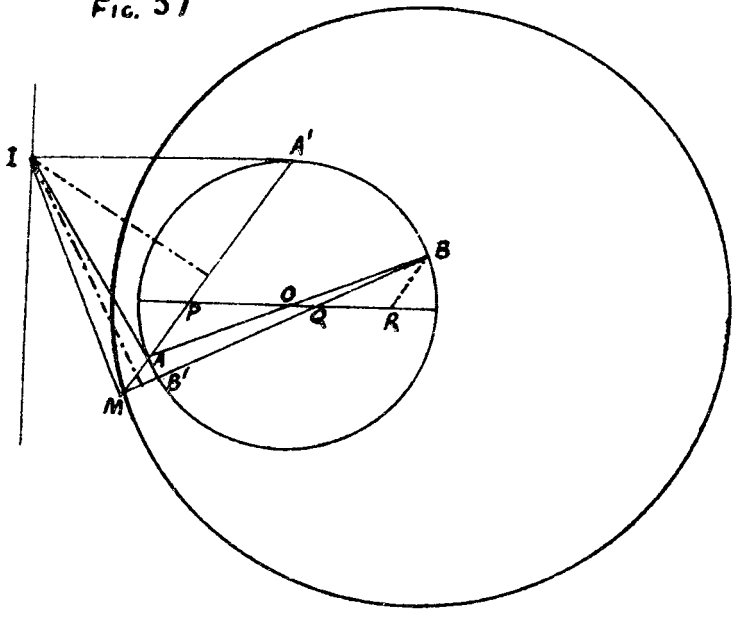

FIG. 52



FIG. 53

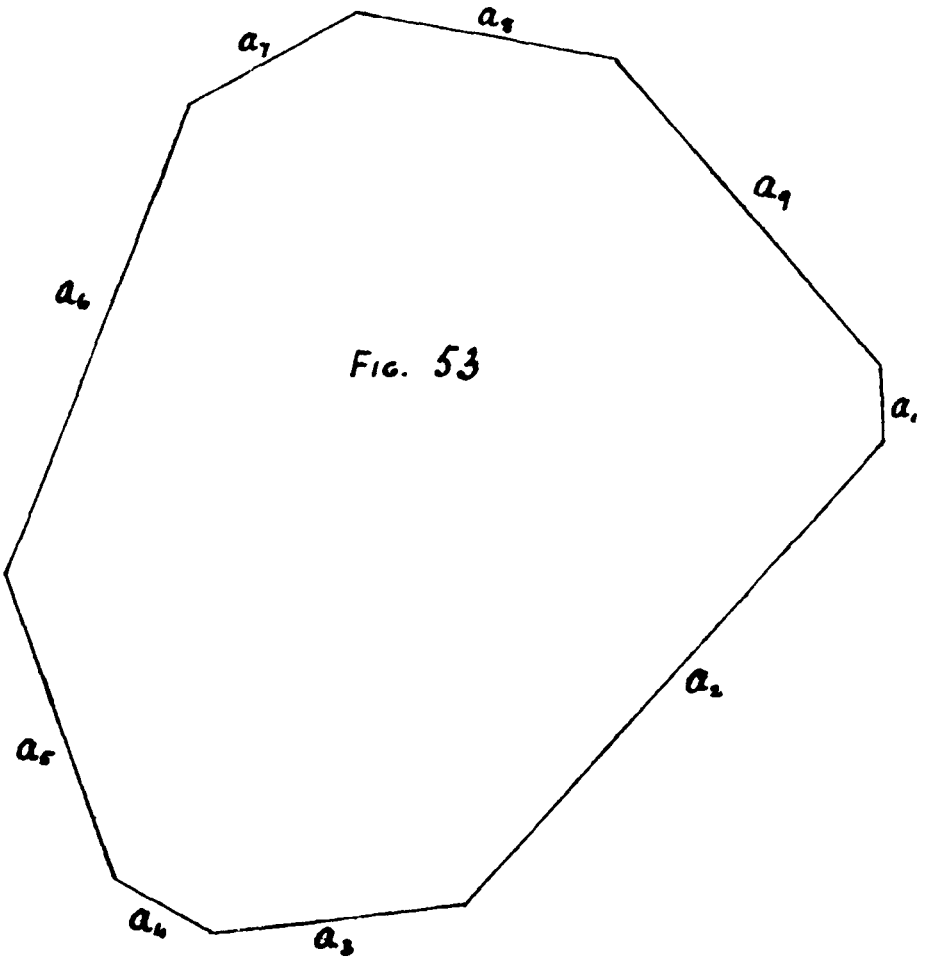



FIG. 54

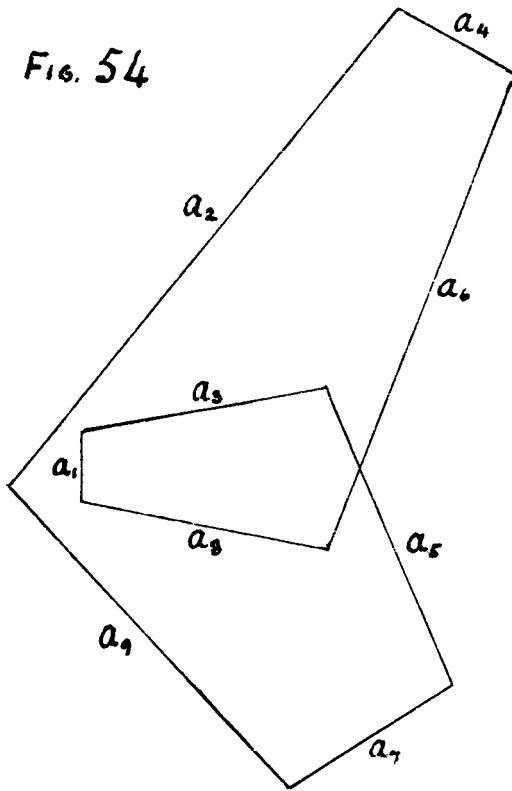
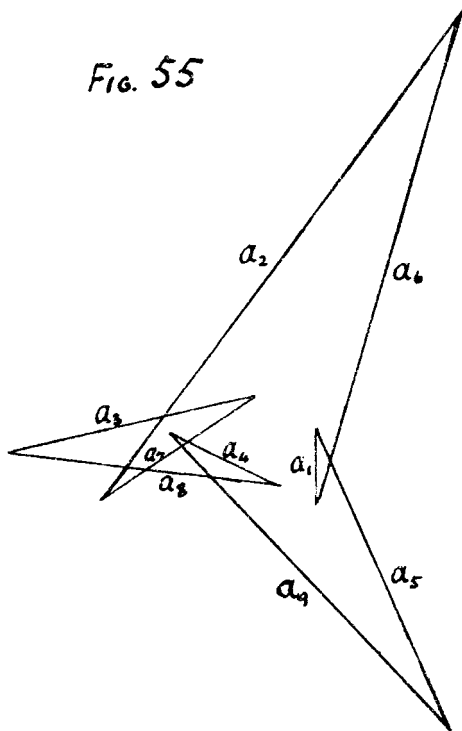
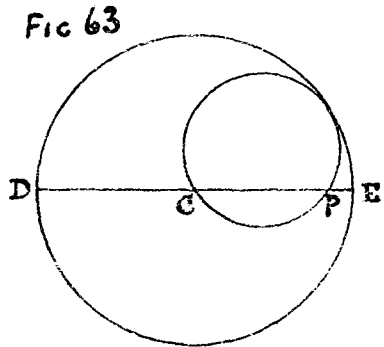
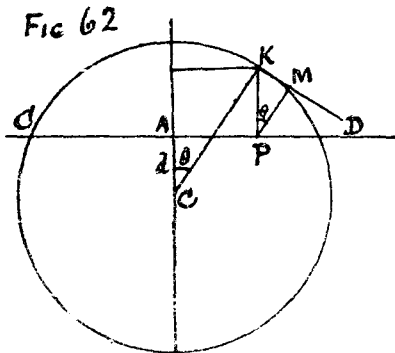
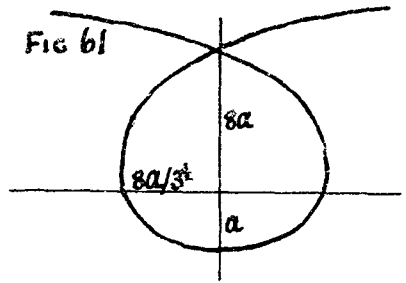
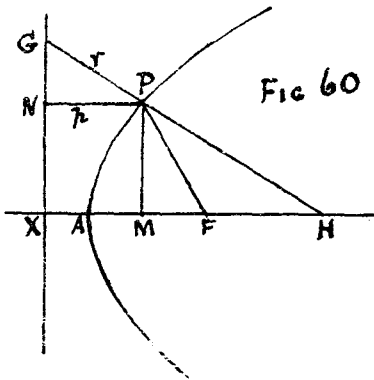
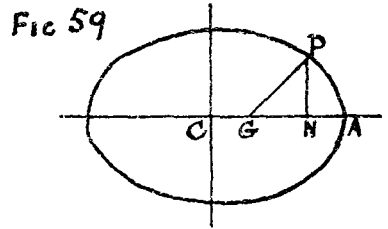
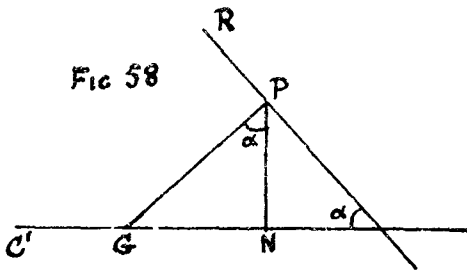
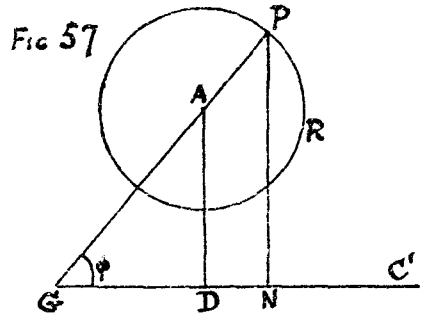
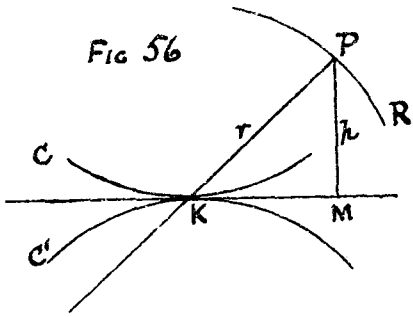

Fig. 55





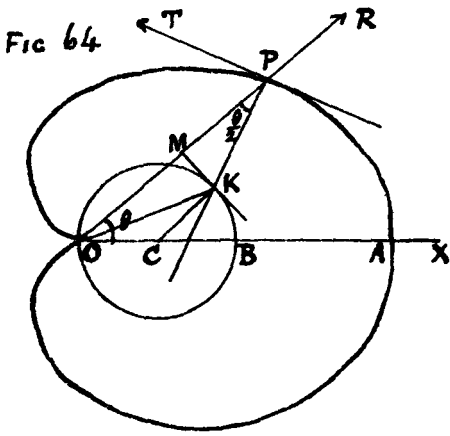

Fig 65

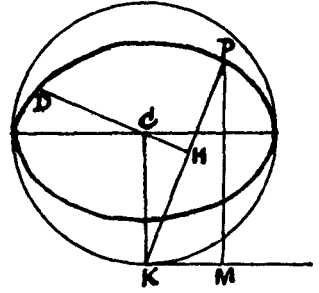

Fig 66

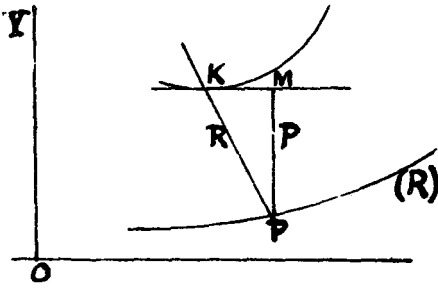

Fig 67

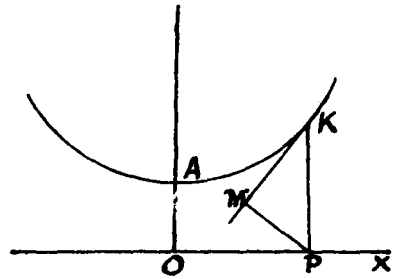

Fig 68

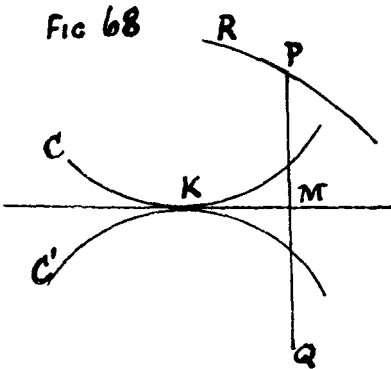

Fig 69

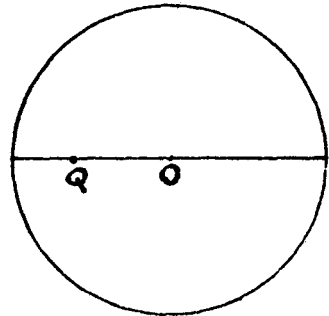



FIG 72

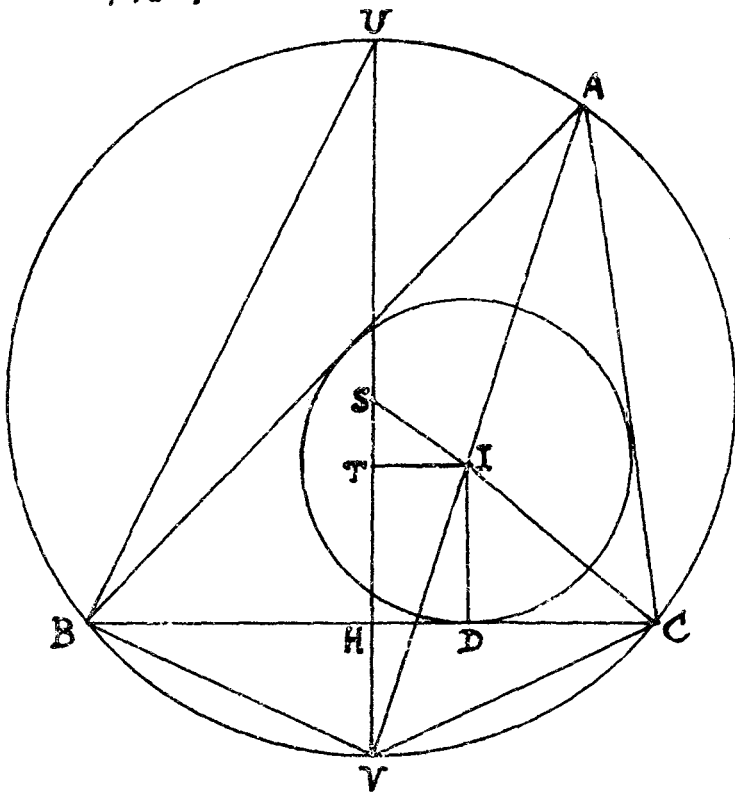
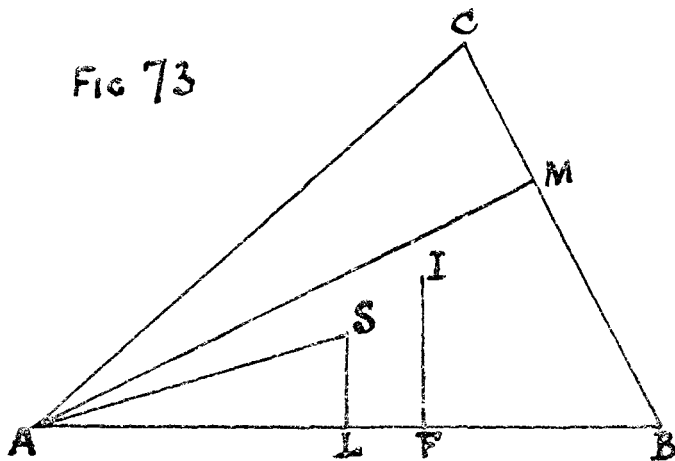
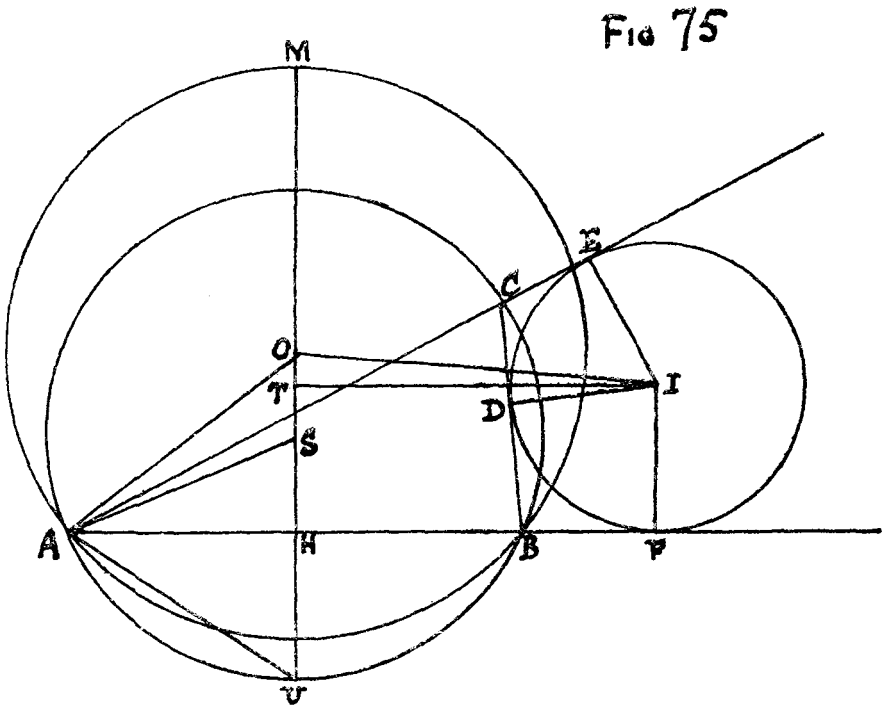
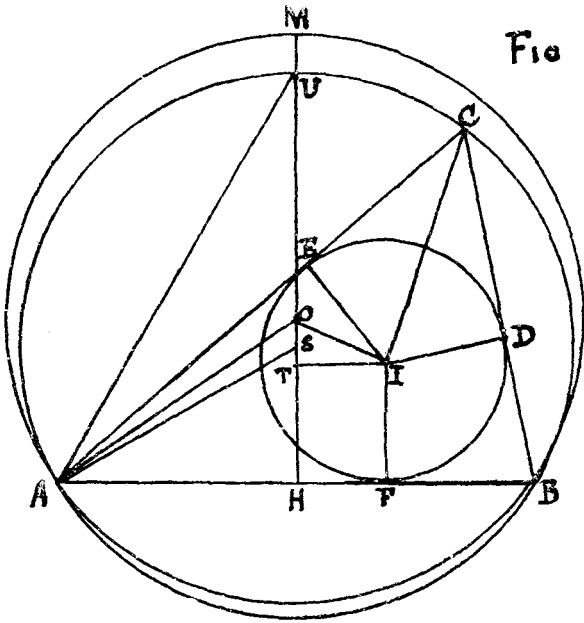

FIG 73





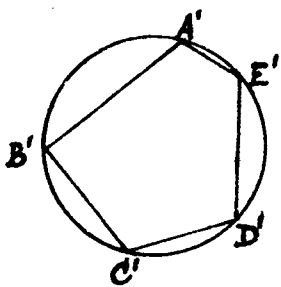

FIG 76

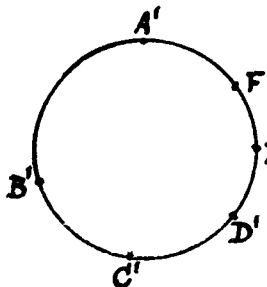
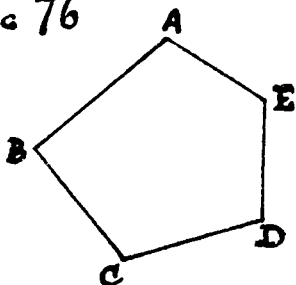

FIG 77

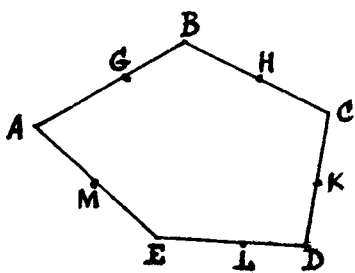
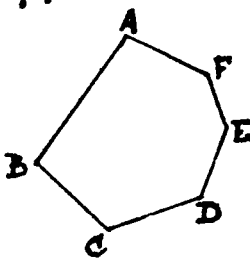

FIG 78

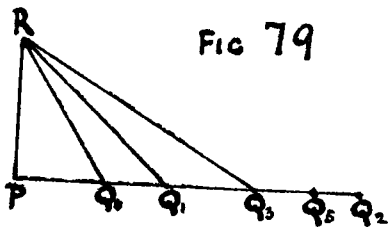
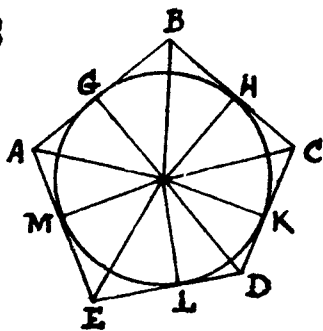

FIG 79

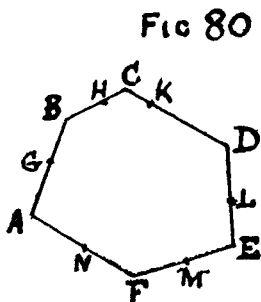

FIG 80



FIG 81.

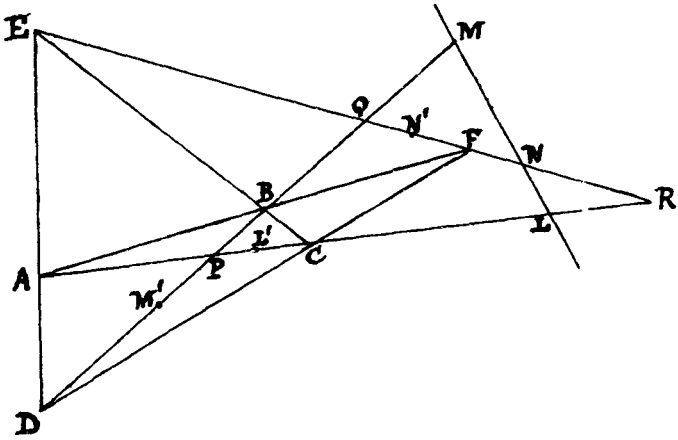
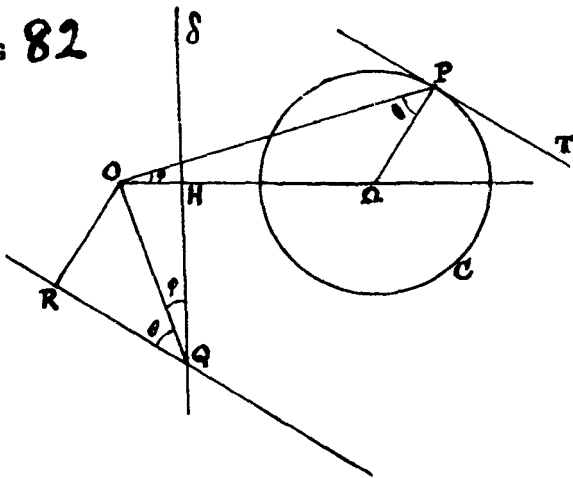

FIG 82



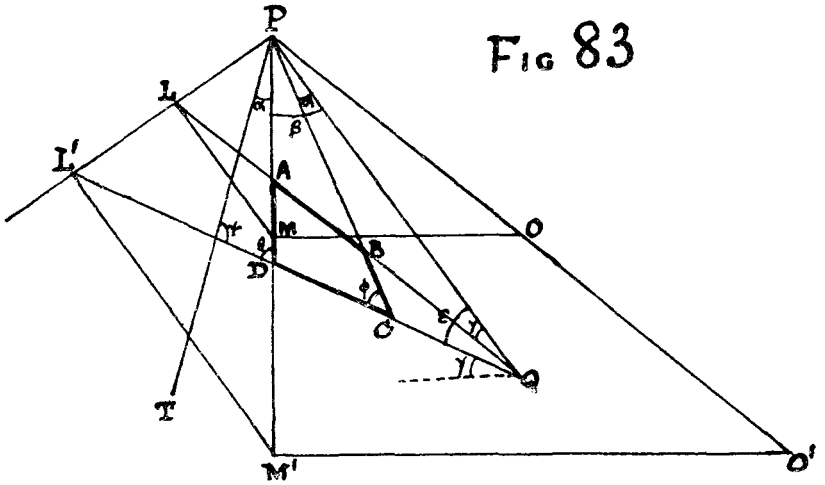

FIG 83

FIG 85

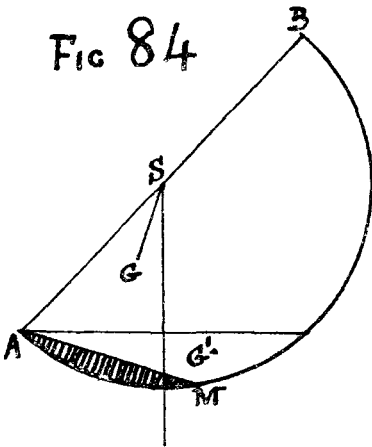

FIG 84

