



RESEARCH ARTICLE

Homological properties of 0-Hecke modules for dual immaculate quasisymmetric functions

Seung-Il Choi¹, Young-Hun Kim², Sun-Young Nam³ and Young-Tak Oh⁴

¹Center for quantum structures in modules and spaces, Seoul National University, 1 Gwanak-ro, Gwanak-gu, Seoul, 08826, Republic of Korea; E-mail: ignatioschoi@snu.ac.kr.

²Center for quantum structures in modules and spaces, Seoul National University, 1 Gwanak-ro, Gwanak-gu, Seoul, 08826, Republic of Korea; E-mail: ykim.math@gmail.com.

³Department of Mathematics, Sogang University, 35 Baekbeom-ro, Mapo-gu, Seoul, 04107, Republic of Korea; E-mail: synam.math@gmail.com.

⁴Department of Mathematics, Sogang University, 35 Baekbeom-ro, Mapo-gu, Seoul, 04107, Republic of Korea; E-mail: ytoh@sogang.ac.kr.

Received: 30 January 2022; Revised: 23 July 2022; Accepted: 9 September 2022

2020 Mathematics Subject Classification: Primary – 20C08; Secondary – 05E05, 05E10

Abstract

Let n be a nonnegative integer. For each composition α of n , Berg, Bergeron, Saliola, Serrano and Zabrocki introduced a cyclic indecomposable $H_n(0)$ -module \mathcal{V}_α with a dual immaculate quasisymmetric function as the image of the quasisymmetric characteristic. In this paper, we study \mathcal{V}_α s from the homological viewpoint. To be precise, we construct a minimal projective presentation of \mathcal{V}_α and a minimal injective presentation of \mathcal{V}_α as well. Using them, we compute $\text{Ext}_{H_n(0)}^1(\mathcal{V}_\alpha, \mathbf{F}_\beta)$ and $\text{Ext}_{H_n(0)}^1(\mathbf{F}_\beta, \mathcal{V}_\alpha)$, where \mathbf{F}_β is the simple $H_n(0)$ -module attached to a composition β of n . We also compute $\text{Ext}_{H_n(0)}^i(\mathcal{V}_\alpha, \mathcal{V}_\beta)$ when $i = 0, 1$ and $\beta \leq_l \alpha$, where \leq_l represents the lexicographic order on compositions.

Contents

1	Introduction	2
2	Preliminaries	4
2.1	Compositions and their diagrams	5
2.2	The 0-Hecke algebra and the quasisymmetric characteristic	5
2.3	Projective modules of the 0-Hecke algebra	6
2.4	The $H_n(0)$ -action on standard immaculate tableaux	7
3	A minimal projective presentation of \mathcal{V}_α and $\text{Ext}_{H_n(0)}^1(\mathcal{V}_\alpha, \mathbf{F}_\beta)$	8
4	A minimal injective presentation of \mathcal{V}_α and $\text{Ext}_{H_n(0)}^1(\mathbf{F}_\beta, \mathcal{V}_\alpha)$	10
5	$\text{Ext}_{H_n(0)}^i(\mathcal{V}_\alpha, \mathcal{V}_\beta)$ with $i = 0, 1$	15
6	Proof of Theorems	20
6.1	Proof of Theorem 3.3	20
6.2	Proof of Theorem 4.1	24
6.3	Proof of Theorem 4.3	26
7	Further avenues	35

1. Introduction

The first systematic work on the representation theory of the 0-Hecke algebras was made by Norton [25], who completely classified all projective indecomposable modules and simple modules, up to isomorphism, for all 0-Hecke algebras of finite type. In the case where $H_n(0)$, the 0-Hecke algebra of type A_{n-1} , they are naturally parametrised by compositions of n . For each composition α of n , let us denote by \mathbf{P}_α and \mathbf{F}_α the projective indecomposable module and the simple module corresponding α , respectively (see Subsection 2.3). These modules were again studied intensively in the 2000s (for instance, see [13, 19, 20]). In particular, Huang [20] studied the induced modules \mathbf{P}_α of projective indecomposable modules by using the combinatorial objects called *standard ribbon tableaux*, where α in bold-face ranges over the set of generalised compositions.

In [15, 22], it was shown that the representation theory of the 0-Hecke algebras of type A has a deep connection to the ring QSym of quasisymmetric functions. Letting $\mathcal{G}_0(H_n(0))$ be the Grothendieck group of the category of finitely generated $H_n(0)$ -modules, their direct sum over all $n \geq 0$ endowed with the induction product is isomorphic to QSym via the *quasisymmetric characteristic*

$$\text{ch} : \bigoplus_{n \geq 0} \mathcal{G}_0(H_n(0)) \rightarrow \text{QSym}, \quad [\mathbf{F}_\alpha] \mapsto F_\alpha.$$

Here, for a composition α of n , $[\mathbf{F}_\alpha]$ is the equivalence class of \mathbf{F}_α inside $\mathcal{G}_0(H_n(0))$, and F_α is the fundamental quasisymmetric function attached to α (for more information; see Subsection 2.2).

Suppose that α ranges over the set of all compositions of n . In the mid-2010s, Berg, Bergeron, Salola, Serrano and Zabrocki [4] introduced the *immaculate functions* \mathfrak{S}_α by applying noncommutative Bernstein operators to the constant power series 1, the identity of the ring NSym of noncommutative symmetric functions. These functions form a basis of NSym . Then the authors defined the *dual immaculate function* \mathfrak{S}_α^* as the quasisymmetric function dual to \mathfrak{S}_α under the appropriate pairing between QSym and NSym ; thus \mathfrak{S}_α^* s also form a basis of QSym . Due to their nice properties, the immaculate and dual immaculate functions have since drawn the attention of many mathematicians (see [6, 7, 10, 11, 17, 18, 24]). In a subsequent paper [5], the same authors successfully construct a cyclic indecomposable $H_n(0)$ -module \mathcal{V}_α with $\text{ch}(\mathcal{V}_\alpha) = \mathfrak{S}_\alpha^*$ by using combinatorial objects called *standard immaculate tableaux*. Although several notable properties have recently been revealed in [12, 21], the structure of \mathcal{V}_α is not yet well known, especially compared to \mathfrak{S}_α^* .

The studies of the 0-Hecke algebras from the homological viewpoint can be found in [9, 14, 16]. For type A , Duchamp, Hivert and Thibon [14, Section 4] construct all nonisomorphic 2-dimensional indecomposable modules and use this result to calculate $\text{Ext}_{H_n(0)}^1(\mathbf{F}_\alpha, \mathbf{F}_\beta)$ for all compositions α, β of n .

Moreover, when $n \leq 4$, they show that its Poincaré series is given by the (α, β) entry of the inverse of $(-q)$ -Cartan matrix. For all finite types, Fayers [16, Section 5] shows that $\dim \text{Ext}_{H_n(0)}^1(M, N) = 1$ or 0 for all simple modules M and N . He also classifies when the dimension equals 1. However, to the best knowledge of the authors, little is known about Ext -groups other than simple (and projective) modules.

In this paper, we study homological properties of \mathcal{V}_α s. To be precise, we explicitly describe a minimal projective presentation and a minimal injective presentation of \mathcal{V}_α . By employing these presentations, we calculate

$$\text{Ext}_{H_n(0)}^1(\mathcal{V}_\alpha, \mathbf{F}_\beta) \quad \text{and} \quad \text{Ext}_{H_n(0)}^1(\mathbf{F}_\beta, \mathcal{V}_\alpha).$$

In addition, we calculate

$$\text{Hom}_{H_n(0)}(\mathcal{V}_\alpha, \mathcal{V}_\beta) \quad \text{and} \quad \text{Ext}_{H_n(0)}^1(\mathcal{V}_\alpha, \mathcal{V}_\beta)$$

for all $\beta \leq_l \alpha$, where \leq_l represents the lexicographic order on compositions. In the following, let us explain our results in more detail.

Let $\alpha = (\alpha_1, \alpha_2, \dots, \alpha_{\ell(\alpha)})$ be a composition of n . The first main result concerns a minimal projective presentation of \mathcal{V}_α . The projective cover $\Phi : \mathbf{P}_\alpha \rightarrow \mathcal{V}_\alpha$, of \mathcal{V}_α has already been provided in

[12, Theorem 3.2]. Let $\mathcal{I}(\alpha) := \{1 \leq i \leq \ell(\alpha) - 1 \mid \alpha_{i+1} \neq 1\}$, and for each $i \in \mathcal{I}(\alpha)$, let $\alpha^{(i)}$ be the generalised composition

$$(\alpha_1, \alpha_2, \dots, \alpha_{i-1}, \alpha_i + 1, \alpha_{i+1} - 1) \oplus (\alpha_{i+2}, \alpha_{i+3}, \dots, \alpha_{\ell(\alpha)}).$$

Then we construct a \mathbb{C} -linear map

$$\partial_1 : \bigoplus_{i \in \mathcal{I}(\alpha)} \mathbf{P}_{\alpha^{(i)}} \longrightarrow \mathbf{P}_{\alpha},$$

which turns out to be an $H_n(0)$ -module homomorphism. Additionally, we show that

$$\ker(\Phi) = \text{Im}(\partial_1) \quad \text{and} \quad \ker(\partial_1) \subseteq \text{rad}\left(\bigoplus_{i \in \mathcal{I}(\alpha)} \mathbf{P}_{\alpha^{(i)}}\right).$$

Hence we obtain the following minimal projective presentation of \mathcal{V}_{α}

$$\bigoplus_{i \in \mathcal{I}(\alpha)} \mathbf{P}_{\alpha^{(i)}} \xrightarrow{\partial_1} \mathbf{P}_{\alpha} \xrightarrow{\Phi} \mathcal{V}_{\alpha} \longrightarrow 0,$$

which enables us to derive that

$$\text{Ext}_{H_n(0)}^1(\mathcal{V}_{\alpha}, \mathbf{F}_{\beta}) \cong \begin{cases} \mathbb{C} & \text{if } \beta \in \mathcal{J}(\alpha), \\ 0 & \text{otherwise} \end{cases}$$

with $\mathcal{J}(\alpha) := \bigcup_{i \in \mathcal{I}(\alpha)} [\alpha^{(i)}]$. Here, given a generalised composition $\alpha = \alpha^{(1)} \oplus \alpha^{(2)} \oplus \dots \oplus \alpha^{(p)}$, we are using the notation $[\alpha]$ to denote the set of all compositions of the form

$$\alpha^{(1)} \square \alpha^{(2)} \square \dots \square \alpha^{(p)},$$

where \square is the concatenation \cdot or near concatenation \odot (Theorem 3.3).

The second main result concerns a minimal injective presentation of \mathcal{V}_{α} . Since $H_n(0)$ is a Frobenius algebra, every finitely generated injective $H_n(0)$ -module is projective. But unlike the projective cover of \mathcal{V}_{α} , there are no known results for an injective hull of \mathcal{V}_{α} . We consider the generalised composition

$$\underline{\alpha} := (\alpha_{k_1} - 1) \oplus (\alpha_{k_2} - 1) \oplus \dots \oplus (\alpha_{k_{m-1}} - 1) \oplus (\alpha_{k_m}, 1^{\ell(\alpha)-1}),$$

where

$$\{k_1 < k_2 < \dots < k_m\} = \{1 \leq i \leq \ell(\alpha) : \alpha_i > 1\}.$$

Then we construct an injective $H_n(0)$ -module homomorphism $\epsilon : \mathcal{V}_{\alpha} \rightarrow \mathbf{P}_{\underline{\alpha}}$ and prove that it is an injective hull of \mathcal{V}_{α} , equivalently, $\text{soc}(\mathbf{P}_{\underline{\alpha}}) \subseteq \epsilon(\mathcal{V}_{\alpha})$ (Theorem 4.1). The next step is to find a map $\partial^1 : \mathbf{P}_{\underline{\alpha}} \rightarrow \mathbf{I}$ with \mathbf{I} injective such that

$$0 \longrightarrow \mathcal{V}_{\alpha} \xrightarrow{\epsilon} \mathbf{P}_{\underline{\alpha}} \xrightarrow{\partial^1} \mathbf{I}$$

is a minimal injective presentation. To do this, to each index $1 \leq j \leq m$, we assign the generalised composition

$$\underline{\alpha}_{(j)} := \begin{cases} (\alpha_{k_1} - 1) \oplus \dots \oplus (\alpha_{k_j} - 2) \oplus \dots \oplus (\alpha_{k_m}, 1^{\ell(\alpha)-k_j+1}) \oplus (1^{k_j-1}) & \text{if } 1 \leq j < m, \\ (\alpha_{k_1} - 1) \oplus \dots \oplus (\alpha_{k_{m-1}} - 1) \oplus ((\alpha_{k_m} - 1, 1^{\ell(\alpha)-k_j+1}) \cdot (1^{k_j-1})) & \text{if } j = m. \end{cases}$$

Then we construct a \mathbb{C} -linear map

$$\partial^1 : \mathbf{P}_{\underline{\alpha}} \longrightarrow \mathbf{I} := \bigoplus_{1 \leq j \leq m} \mathbf{P}_{\underline{\alpha}_{(j)}},$$

which turns out to be an $H_n(0)$ -module homomorphism. We also show that

$$\text{Im}(\epsilon) = \ker(\partial^1) \quad \text{and} \quad \text{soc}(\mathbf{I}) \subseteq \text{Im}(\partial^1).$$

Hence we have the following minimal injective presentation of \mathcal{V}_{α} :

$$0 \longrightarrow \mathcal{V}_{\alpha} \xrightarrow{\epsilon} \mathbf{P}_{\underline{\alpha}} \xrightarrow{\partial^1} \mathbf{I}$$

Let $\Omega^{-1}(\mathcal{V}_{\alpha})$ be the *cosyzygy module* of \mathcal{V}_{α} , the cokernel of ϵ . Applying the formula $\text{Ext}_{H_n(0)}^1(\mathbf{F}_{\beta}, \mathcal{V}_{\alpha}) \cong \text{Hom}_{H_n(0)}(\mathbf{F}_{\beta}, \Omega^{-1}(\mathcal{V}_{\alpha}))$ to this minimal injective presentation enables us to derive that

$$\text{Ext}_{H_n(0)}^1(\mathbf{F}_{\beta}, \mathcal{V}_{\alpha}) \cong \begin{cases} \mathbb{C}^{[\mathcal{L}(\alpha); \beta^r]} & \text{if } \beta^r \in \mathcal{L}(\alpha), \\ 0 & \text{otherwise,} \end{cases}$$

where $\mathcal{L}(\alpha)$ is the multiset $\bigcup_{1 \leq j \leq m} [\underline{\alpha}_{(j)}]$, β^r the reverse composition of β and $[\mathcal{L}(\alpha) : \beta^r]$ the multiplicity of β^r in $\mathcal{L}(\alpha)$ (Theorem 4.3).

The third main result concerns $\text{Ext}_{H_n(0)}^i(\mathcal{V}_{\alpha}, \mathcal{V}_{\beta})$ for $i = 0, 1$. We show that whenever $\beta \leq_l \alpha$,

$$\text{Ext}_{H_n(0)}^1(\mathcal{V}_{\alpha}, \mathcal{V}_{\beta}) = 0 \quad \text{and} \quad \text{Ext}_{H_n(0)}^0(\mathcal{V}_{\alpha}, \mathcal{V}_{\beta}) \cong \begin{cases} \mathbb{C} & \text{if } \beta = \alpha, \\ 0 & \text{otherwise.} \end{cases}$$

Given a finite-dimensional $H_n(0)$ -module M , we say that M is *rigid* if $\text{Ext}_{H_n(0)}^1(M, M) = 0$ and *essentially rigid* if $\text{Hom}_{H_n(0)}(\Omega(M), M) = 0$, where $\Omega(M)$ is the *syzygy module* of M . With this definition, we also prove that \mathcal{V}_{α} is essentially rigid for every composition α of n (Theorem 5.4). In the case where $\beta >_l \alpha$, the structure of $\text{Ext}_{H_n(0)}^i(\mathcal{V}_{\alpha}, \mathcal{V}_{\beta})$ for $i = 0, 1$ is still beyond our understanding.

For instance, each map in $\text{Ext}_{H_n(0)}^0(\mathcal{V}_{\alpha}, \mathcal{V}_{\beta})$ is completely determined by the value of a cyclic generator of \mathcal{V}_{α} . However, at the moment, it seems difficult to characterise all possible values the generator can have. Instead, we view $\text{Ext}_{H_n(0)}^0(\mathcal{V}_{\alpha}, \mathcal{V}_{\beta})$ as the set of $H_n(0)$ -module homomorphisms from \mathbf{P}_{α} to \mathcal{V}_{β} that vanish on $\Omega(\mathcal{V}_{\alpha})$. The most important reason for taking this view is that we know a minimal generating set of \mathcal{V}_{α} as well as a combinatorial description of $\dim_{\mathbb{C}} \text{Ext}_{H_n(0)}^0(\mathbf{P}_{\alpha}, \mathcal{V}_{\beta})$. An approach in this direction is given in Theorem 5.6.

This paper is organised as follows. In Section 2, we introduce the prerequisites on the 0-Hecke algebra, including the quasisymmetric characteristic, standard ribbon tableaux, standard immaculate tableaux and $H_n(0)$ -modules associated to such tableaux. In Section 3, we provide a minimal projective presentation of \mathcal{V}_{α} and $\text{Ext}_{H_n(0)}^1(\mathcal{V}_{\alpha}, \mathbf{F}_{\beta})$. And in Section 4, we provide a minimal injective presentation of \mathcal{V}_{α} and $\text{Ext}_{H_n(0)}^1(\mathbf{F}_{\beta}, \mathcal{V}_{\alpha})$. In Section 5, we investigate $\text{Ext}_{H_n(0)}^i(\mathcal{V}_{\alpha}, \mathcal{V}_{\beta})$ for $i = 0, 1$. Section 6 is devoted to proving the first and second main results of this paper. In the last section, we provide some future directions to pursue.

2. Preliminaries

In this section, n denotes a nonnegative integer. Define $[n]$ to be $\{1, 2, \dots, n\}$ if $n > 0$ or \emptyset otherwise. In addition, we set $[-1] := \emptyset$. For positive integers $i \leq j$, set $[i, j] := \{i, i + 1, \dots, j\}$.

2.1. Compositions and their diagrams

A composition α of a nonnegative integer n , denoted by $\alpha \models n$, is a finite ordered list of positive integers $(\alpha_1, \alpha_2, \dots, \alpha_k)$ satisfying $\sum_{i=1}^k \alpha_i = n$. For each $1 \leq i \leq k$, let us call α_i a *part* of α . And we call $k =: \ell(\alpha)$ the *length* of α and $n =: |\alpha|$ the *size* of α . For convenience, we define the empty composition \emptyset to be the unique composition of size and length 0. A *generalised composition* α of n is a formal sum $\alpha^{(1)} \oplus \alpha^{(2)} \oplus \dots \oplus \alpha^{(k)}$, where $\alpha^{(i)} \models n_i$ for positive integers n_i s with $n_1 + n_2 + \dots + n_k = n$.

For $\alpha = (\alpha_1, \alpha_2, \dots, \alpha_{\ell(\alpha)}) \models n$, we define the *composition diagram* $cd(\alpha)$ of α as a left-justified array of n boxes where the i th row from the top has α_i boxes for $1 \leq i \leq k$. We also define the *ribbon diagram* $rd(\alpha)$ of α by the connected skew diagram without 2×2 boxes, such that the i th column from the left has α_i boxes. Then for a generalised composition α of n , we define the *generalised ribbon diagram* $rd(\alpha)$ of α to be the skew diagram whose connected components are $rd(\alpha^{(1)})$, $rd(\alpha^{(2)})$, \dots , $rd(\alpha^{(k)})$ such that $rd(\alpha^{(i+1)})$ is strictly to the northeast of $rd(\alpha^{(i)})$ for $i = 1, 2, \dots, k - 1$. For example, if $\alpha = (3, 1, 2)$ and $\alpha = (2, 1) \oplus (1, 1)$, then

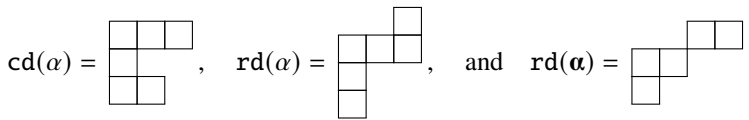

Given $\alpha = (\alpha_1, \alpha_2, \dots, \alpha_{\ell(\alpha)}) \models n$ and $I = \{i_1 < i_2 < \dots < i_k\} \subset [n - 1]$, let

$$\text{set}(\alpha) := \{\alpha_1, \alpha_1 + \alpha_2, \dots, \alpha_1 + \alpha_2 + \dots + \alpha_{\ell(\alpha)-1}\},$$

$$\text{comp}(I) := (i_1, i_2 - i_1, \dots, n - i_k).$$

The set of compositions of n is in bijection with the set of subsets of $[n - 1]$ under the correspondence $\alpha \mapsto \text{set}(\alpha)$ (or $I \mapsto \text{comp}(I)$). Let α^r denote the composition $(\alpha_{\ell(\alpha)}, \alpha_{\ell(\alpha)-1}, \dots, \alpha_1)$.

For compositions $\alpha = (\alpha_1, \alpha_2, \dots, \alpha_k)$ and $\beta = (\beta_1, \beta_2, \dots, \beta_l)$, let $\alpha \cdot \beta$ be the *concatenation* and $\alpha \odot \beta$ the *near concatenation* of α and β . In other words, $\alpha \cdot \beta = (\alpha_1, \alpha_2, \dots, \alpha_k, \beta_1, \beta_2, \dots, \beta_l)$ and $\alpha \odot \beta = (\alpha_1, \dots, \alpha_{k-1}, \alpha_k + \beta_1, \beta_2, \dots, \beta_l)$. For a generalised composition $\alpha = \alpha^{(1)} \oplus \alpha^{(2)} \oplus \dots \oplus \alpha^{(m)}$, define

$$[\alpha] := \{\alpha^{(1)} \square \alpha^{(2)} \square \dots \square \alpha^{(m)} \mid \square = \cdot \text{ or } \odot\}.$$

2.2. The 0-Hecke algebra and the quasisymmetric characteristic

The symmetric group Σ_n is generated by simple transpositions $s_i := (i \ i+1)$ with $1 \leq i \leq n - 1$. An expression for $\sigma \in \Sigma_n$ of the form $s_{i_1} s_{i_2} \dots s_{i_p}$ that uses the minimal number of simple transpositions is called a *reduced expression* for σ . The number of simple transpositions in any reduced expression for σ , denoted by $\ell(\sigma)$, is called the *length* of σ .

The 0-Hecke algebra $H_n(0)$ is the \mathbb{C} -algebra generated by $\pi_1, \pi_2, \dots, \pi_{n-1}$ subject to the following relations:

$$\pi_i^2 = \pi_i \quad \text{for } 1 \leq i \leq n - 1,$$

$$\pi_i \pi_{i+1} \pi_i = \pi_{i+1} \pi_i \pi_{i+1} \quad \text{for } 1 \leq i \leq n - 2,$$

$$\pi_i \pi_j = \pi_j \pi_i \quad \text{if } |i - j| \geq 2.$$

Pick up any reduced expression $s_{i_1} s_{i_2} \dots s_{i_p}$ for a permutation $\sigma \in \Sigma_n$. It is well known that the element $\pi_\sigma := \pi_{i_1} \pi_{i_2} \dots \pi_{i_p}$ is independent of the choice of reduced expressions and $\{\pi_\sigma \mid \sigma \in \Sigma_n\}$ is a basis for $H_n(0)$. For later use, set

$$\pi_{[i,j]} := \pi_i \pi_{i+1} \dots \pi_j \quad \text{and} \quad \pi_{[i,j]^r} := \pi_j \pi_{j-1} \dots \pi_i$$

for all $1 \leq i \leq j \leq n - 1$.

Let $\mathcal{R}(H_n(0))$ denote the \mathbb{Z} -span of (representatives of) the isomorphism classes of finite-dimensional representations of $H_n(0)$. The isomorphism class corresponding to an $H_n(0)$ -module M will be denoted by $[M]$. The Grothendieck group $\mathcal{G}_0(H_n(0))$ is the quotient of $\mathcal{R}(H_n(0))$ modulo the relations $[M] = [M'] + [M'']$ whenever there exists a short exact sequence $0 \rightarrow M' \rightarrow M \rightarrow M'' \rightarrow 0$. The equivalence classes of irreducible representations of $H_n(0)$ form a free \mathbb{Z} -basis for $\mathcal{G}_0(H_n(0))$. Let

$$\mathcal{G} := \bigoplus_{n \geq 0} \mathcal{G}_0(H_n(0)).$$

According to [25], there are 2^{n-1} distinct irreducible representations of $H_n(0)$. They are naturally indexed by compositions of n . Let \mathbf{F}_α denote the 1-dimensional \mathbb{C} -vector space corresponding to $\alpha \models n$, spanned by a vector v_α . For each $1 \leq i \leq n-1$, define an action of the generator π_i of $H_n(0)$ as follows:

$$\pi_i \cdot v_\alpha = \begin{cases} 0 & i \in \text{set}(\alpha), \\ v_\alpha & i \notin \text{set}(\alpha). \end{cases}$$

Then \mathbf{F}_α is an irreducible 1-dimensional $H_n(0)$ -representation.

In the following, let us review the connection between \mathcal{G} and the ring QSym of quasisymmetric functions. Quasisymmetric functions are power series of bounded degree in variables x_1, x_2, x_3, \dots with coefficients in \mathbb{Z} that are shift invariant in the sense that the coefficient of the monomial $x_1^{\alpha_1} x_2^{\alpha_2} \dots x_k^{\alpha_k}$ is equal to the coefficient of the monomial $x_{i_1}^{\alpha_1} x_{i_2}^{\alpha_2} \dots x_{i_k}^{\alpha_k}$ for any strictly increasing sequence of positive integers $i_1 < i_2 < \dots < i_k$ indexing the variables and any positive integer sequence $(\alpha_1, \alpha_2, \dots, \alpha_k)$ of exponents.

Given a composition α , the fundamental quasisymmetric function F_α is defined by $F_\emptyset = 1$ and

$$F_\alpha = \sum_{\substack{1 \leq i_1 \leq i_2 \leq \dots \leq i_k \\ i_j < i_{j+1} \text{ if } j \in \text{set}(\alpha)}} x_{i_1} x_{i_2} \dots x_{i_k}.$$

It is well known that $\{F_\alpha \mid \alpha \text{ is a composition}\}$ is a basis for QSym . In [15], Duchamp, Krob, Leclerc and Thibon show that, when \mathcal{G} is equipped with induction product, the linear map

$$\text{ch} : \mathcal{G} \rightarrow \text{QSym}, \quad [\mathbf{F}_\alpha] \mapsto F_\alpha,$$

called the *quasisymmetric characteristic*, is a ring isomorphism.

2.3. Projective modules of the 0-Hecke algebra

We begin this subsection by recalling that $H_n(0)$ is a Frobenius algebra. Hence it is self-injective, so that finitely generated projective and injective modules coincide (see [14, Proposition 4.1], [16, Proposition 4.1] and [3, Proposition 1.6.2]).

It was Norton [25] who first classified all projective indecomposable modules of $H_n(0)$ up to isomorphism that bijectively correspond to compositions of n . Later, Huang [20] provided a combinatorial description of these modules and their induction products as well by using standard ribbon tableaux of generalised composition shape. We review Huang’s description very briefly here.

Definition 2.1. For a generalised composition α of n , a *standard ribbon tableau* (SRT) of shape α is a filling of $\text{rd}(\alpha)$ with $\{1, 2, \dots, n\}$ such that the entries are all distinct, the entries in each row are increasing from left to right, and the entries in each column are increasing from top to bottom.

Let $\text{SRT}(\alpha)$ denote the set of all SRTx of shape α . For $T \in \text{SRT}(\alpha)$, let

$$\text{Des}(T) := \{i \in [n-1] \mid i \text{ appears weakly below } i+1 \text{ in } T\}.$$

Define an $H_n(0)$ -action on the \mathbb{C} -span of $\text{SRT}(\alpha)$ by

$$\pi_i \cdot T = \begin{cases} T & \text{if } i \notin \text{Des}(T), \\ 0 & \text{if } i \text{ and } i + 1 \text{ are in the same row of } T, \\ s_i \cdot T & \text{if } i \text{ appears strictly below } i + 1 \text{ in } T \end{cases} \tag{2.1}$$

for $1 \leq i \leq n - 1$ and $T \in \text{SRT}(\alpha)$. Here $s_i \cdot T$ is obtained from T by swapping i and $i + 1$. The resulting module is denoted by \mathbf{P}_α . It is known that the set $\{\mathbf{P}_\alpha \mid \alpha \models n\}$ forms a complete family of non-isomorphic projective indecomposable $H_n(0)$ -modules and $\mathbf{P}_\alpha/\text{rad}(\mathbf{P}_\alpha) \cong \mathbf{F}_\alpha$, where $\text{rad}(\mathbf{P}_\alpha)$ is the radical of \mathbf{P}_α (for details; see [20, 25]).

Remark 2.2. It should be pointed out that the ribbon diagram and $H_n(0)$ -action used here are slightly different from those in Huang’s work [20]. He describes the $H_n(0)$ -action on \mathbf{P}_α in terms of $\bar{\pi}_i$ s, where $\bar{\pi}_i = \pi_i - 1$. On the other hand, we use π_i s because the $H_n(0)$ -action on \mathcal{V}_α is described in terms of π_i s. This leads us to adjust Huang’s ribbon diagram to the form of $\text{rd}(\alpha)$.

Given any generalised composition α , let $T_\alpha \in \text{SRT}(\alpha)$ be the SRT obtained by filling $\text{rd}(\alpha)$ with entries $1, 2, \dots, n$ from top to bottom and from left to right. Since \mathbf{P}_α is cyclically generated by T_α , we call T_α the *source tableau* of \mathbf{P}_α . For any SRTT, let $\mathbf{w}(T)$ be the word obtained by reading the entries from left to right, starting with the bottom row. Using this reading, Huang [20] shows the following result.

Theorem 2.3 ([20, Theorem 3.3]). *Let α be a generalised composition of n . Then \mathbf{P}_α is isomorphic to $\bigoplus_{\beta \in [\alpha]} \mathbf{P}_\beta$ as an $H_n(0)$ -module.*

For later use, for every generalised composition α of n , we define a partial order \leq on $\text{SRT}(\alpha)$ by

$$T \leq T' \quad \text{if and only if} \quad T' = \pi_\sigma \cdot T \quad \text{for some } \sigma \in \Sigma_n.$$

As usual, whenever $T \leq T'$, the notation $[T, T']$ denotes the interval $\{U \in \text{SRT}(\alpha) \mid T \leq U \leq T'\}$.

2.4. The $H_n(0)$ -action on standard immaculate tableaux

Noncommutative Bernstein operators were introduced by Berg, Bergeron, Saliola, Serrano and Zabrocki [4]. Applied to the identity of the ring NSym of noncommutative symmetric functions, they yield the *immaculate functions*, which form a basis of NSym . Soon after, using the combinatorial objects called standard immaculate tableaux, they constructed indecomposable $H_n(0)$ -modules whose quasisymmetric characteristics are the quasisymmetric functions that are dual to immaculate functions (see [5]).

Definition 2.4. Let $\alpha \models n$. A *standard immaculate tableau* (SIT) of shape α is a filling \mathcal{T} of the composition diagram $\text{cd}(\alpha)$ with $\{1, 2, \dots, n\}$ such that the entries are all distinct, the entries in each row increase from left to right, and the entries in the first column increase from top to bottom.

We denote the set of all SITx of shape α by $\text{SIT}(\alpha)$. For $\mathcal{T} \in \text{SIT}(\alpha)$, let

$$\text{Des}(\mathcal{T}) := \{i \in [n - 1] \mid i \text{ appears strictly above } i + 1 \text{ in } \mathcal{T}\}.$$

Define an $H_n(0)$ -action on \mathbb{C} -span of $\text{SIT}(\alpha)$ by

$$\pi_i \cdot \mathcal{T} = \begin{cases} \mathcal{T} & \text{if } i \notin \text{Des}(\mathcal{T}), \\ 0 & \text{if } i \text{ and } i + 1 \text{ are in the first column of } \mathcal{T}, \\ s_i \cdot \mathcal{T} & \text{otherwise} \end{cases} \tag{2.2}$$

for $1 \leq i \leq n - 1$ and $\mathcal{T} \in \text{SIT}(\alpha)$. Here $s_i \cdot \mathcal{T}$ is obtained from \mathcal{T} by swapping i and $i + 1$. The resulting module is denoted by \mathcal{V}_α .

Let $\mathcal{T}_\alpha \in \text{SIT}(\alpha)$ be the SIT obtained by filling $\text{cd}(\alpha)$ with entries $1, 2, \dots, n$ from left to right and from top to bottom.

Theorem 2.5 ([5]). *For $\alpha \models n$, \mathcal{V}_α is a cyclic indecomposable $H_n(0)$ -module generated by \mathcal{T}_α whose quasisymmetric characteristic is the dual immaculate quasisymmetric function \mathfrak{S}_α^* .*

Convention. Regardless of a ribbon diagram or composition diagram, columns are numbered from left to right. To avoid possible confusion, we adopt the following notation:

- (i) Let T be a filling of the ribbon diagram $\text{rd}(\alpha)$.
 - T_j^i = the entry at the i th box from the top of the j th column
 - T_j^{-1} = the entry at the bottom-most box in the j th column
 - T_j^\bullet = the set of all entries in the j th column
- (ii) Let \mathcal{T} be a filling of the composition diagram $\text{cd}(\alpha)$.
 - $\mathcal{T}_{i,j}$ = the entry at the box in the i th row (from the top) and in the j th column

3. A minimal projective presentation of \mathcal{V}_α and $\text{Ext}_{H_n(0)}^1(\mathcal{V}_\alpha, \mathbf{F}_\beta)$

From now on, α denotes an arbitrarily chosen composition of n . We here construct a minimal projective presentation of \mathcal{V}_α . Using this, we compute $\text{Ext}_{H_n(0)}^1(\mathcal{V}_\alpha, \mathbf{F}_\beta)$ for each $\beta \models n$.

Firstly, let us introduce necessary terminologies and notation. Let A, B be finitely generated $H_n(0)$ -modules. A surjective $H_n(0)$ -module homomorphism $f : A \rightarrow B$ is called an *essential epimorphism* if an $H_n(0)$ -module homomorphism $g : X \rightarrow A$ is surjective whenever $f \circ g : X \rightarrow B$ is surjective. A *projective cover* of A is an essential epimorphism $f : P \rightarrow A$ with P projective that always exists and is unique up to isomorphism. It is well known that $f : P \rightarrow A$ is an essential epimorphism if and only if $\ker(f) \subset \text{rad}(P)$ (for instance, see [1, Proposition I.3.6]). For simplicity, when f is clear in the context, we just write $\Omega(A)$ for $\ker(f)$ and call it the *syzygy module* of A . An exact sequence

$$P_1 \xrightarrow{\partial_1} P_0 \xrightarrow{\epsilon} A \longrightarrow 0$$

with projective modules P_0 and P_1 is called a *minimal projective presentation* if the $H_n(0)$ -module homomorphisms $\epsilon : P_0 \rightarrow A$ and $\partial_1 : P_1 \rightarrow \Omega(A)$ are projective covers of A and $\Omega(A)$, respectively.

Next, let us review the projective cover of \mathcal{V}_α obtained in [12]. Given any $T \in \text{SRT}(\alpha)$, let \mathcal{T}_T be the filling of $\text{cd}(\alpha)$ given by $(\mathcal{T}_T)_{i,j} = T_i^j$. Then we define a \mathbb{C} -linear map $\Phi : \mathbf{P}_\alpha \rightarrow \mathcal{V}_\alpha$ by

$$\Phi(T) = \begin{cases} \mathcal{T}_T & \text{if } \mathcal{T}_T \text{ is an SIT,} \\ 0 & \text{otherwise.} \end{cases} \tag{3.1}$$

For example, if $\alpha = (1, 2, 2)$ and

$$T_1 = \begin{array}{|c|c|c|} \hline & & 4 \\ \hline 2 & 5 & \\ \hline 1 & 3 & \\ \hline \end{array} \in \text{SRT}(\alpha) \quad \text{and} \quad T_2 = \begin{array}{|c|c|c|} \hline & & 4 \\ \hline 1 & 5 & \\ \hline 2 & 3 & \\ \hline \end{array} \in \text{SRT}(\alpha),$$

then

$$\mathcal{T}_{T_1} = \begin{array}{|c|c|c|} \hline 1 & & \\ \hline 2 & 3 & \\ \hline 4 & 5 & \\ \hline \end{array} \in \text{SIT}(\alpha) \quad \text{and} \quad \mathcal{T}_{T_2} = \begin{array}{|c|c|c|} \hline 2 & & \\ \hline 1 & 3 & \\ \hline 4 & 5 & \\ \hline \end{array} \notin \text{SIT}(\alpha).$$

Therefore, $\Phi(T_1) = \mathcal{T}_{T_1}$ and $\Phi(T_2) = 0$.

Theorem 3.1 ([12, Theorem 3.2]). *For $\alpha \models n$, $\Phi : \mathbf{P}_\alpha \rightarrow \mathcal{V}_\alpha$ is a projective cover of \mathcal{V}_α .*

Now, let us construct a projective cover of $\Omega(\mathcal{V}_\alpha)$ for each $\alpha \models n$. To do this, we provide necessary notation. For each integer $0 \leq i \leq \ell(\alpha) - 1$, we set m_i to be $\sum_{j=1}^i \alpha_j$ for $i > 0$ and $m_0 = 0$. Let

$$\mathcal{I}(\alpha) := \{1 \leq i \leq \ell(\alpha) - 1 \mid \alpha_{i+1} \neq 1\}.$$

Given $i \in \mathcal{I}(\alpha)$, let

$$T_\alpha^{(i)} := \pi_{[m_{i-1}+1, m_i]} \cdot T_\alpha$$

and

$$\alpha^{(i)} := (\alpha_1, \alpha_2, \dots, \alpha_{i-1}, \alpha_i + 1, \alpha_{i+1} - 1) \oplus (\alpha_{i+2}, \alpha_{i+3}, \dots, \alpha_{\ell(\alpha)}).$$

Given an SRT τ of shape $\alpha^{(i)}$ ($i \in \mathcal{I}(\alpha)$), define $L(\tau)$ to be the filling of $\text{rd}(\alpha)$ whose entries in each column are increasing from top to bottom and whose columns are given as follows: for $1 \leq p \leq \ell(\alpha)$,

$$L(\tau)_p^\bullet = \begin{cases} \tau_i^\bullet \setminus \{\tau_i^1\} & \text{if } p = i, \\ \tau_{i+1}^\bullet \cup \{\tau_i^1\} & \text{if } p = i + 1, \\ \tau_p^\bullet & \text{otherwise.} \end{cases} \tag{3.2}$$

Example 3.2. For $\tau_1 = \begin{array}{|c|} \hline 3 \\ \hline 1 & 5 \\ \hline 2 \\ \hline \end{array}$ and $\tau_2 = \begin{array}{|c|} \hline 1 \\ \hline 2 & 5 \\ \hline 3 & 4 \\ \hline \end{array}$, we have $L(\tau_1) = \begin{array}{|c|} \hline 1 \\ \hline 3 & 4 \\ \hline 2 & 5 \\ \hline \end{array}$ and $L(\tau_2) = \begin{array}{|c|} \hline 1 \\ \hline 2 & 3 \\ \hline 4 & 5 \\ \hline \end{array}$.

For each $i \in \mathcal{I}(\alpha)$, we define a \mathbb{C} -linear map $\partial_1^{(i)} : \mathbf{P}_{\alpha^{(i)}} \rightarrow H_n(0) \cdot T_\alpha^{(i)}$ by

$$\partial_1^{(i)}(\tau) = \begin{cases} L(\tau) & \text{if } L(\tau) \in \text{SRT}(\alpha), \\ 0 & \text{otherwise.} \end{cases}$$

Then we define a \mathbb{C} -linear map $\partial_1 : \bigoplus_{i \in \mathcal{I}(\alpha)} \mathbf{P}_{\alpha^{(i)}} \rightarrow \mathbf{P}_\alpha$ by

$$\partial_1 := \sum_{i \in \mathcal{I}(\alpha)} \partial_1^{(i)}.$$

Theorem 3.3 (This will be proven in Subsection 6.1). *Let α be a composition of n .*

- (a) $\text{Im}(\partial_1) = \Omega(\mathcal{V}_\alpha)$ and $\partial_1 : \bigoplus_{i \in \mathcal{I}(\alpha)} \mathbf{P}_{\alpha^{(i)}} \rightarrow \Omega(\mathcal{V}_\alpha)$ is a projective cover of $\Omega(\mathcal{V}_\alpha)$.
- (b) Let $\mathcal{J}(\alpha) := \bigcup_{i \in \mathcal{I}(\alpha)} [\alpha^{(i)}]$. Then we have

$$\text{Ext}_{H_n(0)}^1(\mathcal{V}_\alpha, \mathbf{F}_\beta) \cong \begin{cases} \mathbb{C} & \text{if } \beta \in \mathcal{J}(\alpha), \\ 0 & \text{otherwise.} \end{cases}$$

Example 3.4. Let $\alpha = (1, 2, 1)$. Then we have that $\mathcal{I}(\alpha) = \{1\}$ and $\alpha^{(1)} = (2, 1) \oplus (1)$.

(a) The map $\partial_1 : \mathbf{P}_{(2,1) \oplus (1)} \rightarrow \mathbf{P}_{(1,2,1)}$ is illustrated in Figure 1, where the entries i in red in each SRT T are used to indicate that $\pi_i \cdot T = 0$.

(b) Note that $\mathcal{J}(\alpha) = [\alpha^{(1)}] = \{(2, 2), (2, 1, 1)\}$. By Theorem 3.3(b), we have

$$\dim \text{Ext}_{H_n(0)}^1(\mathcal{V}_{(1,2,1)}, \mathbf{F}_\beta) = \begin{cases} 1 & \text{if } \beta = (2, 2) \text{ or } (2, 1, 1), \\ 0 & \text{otherwise.} \end{cases}$$

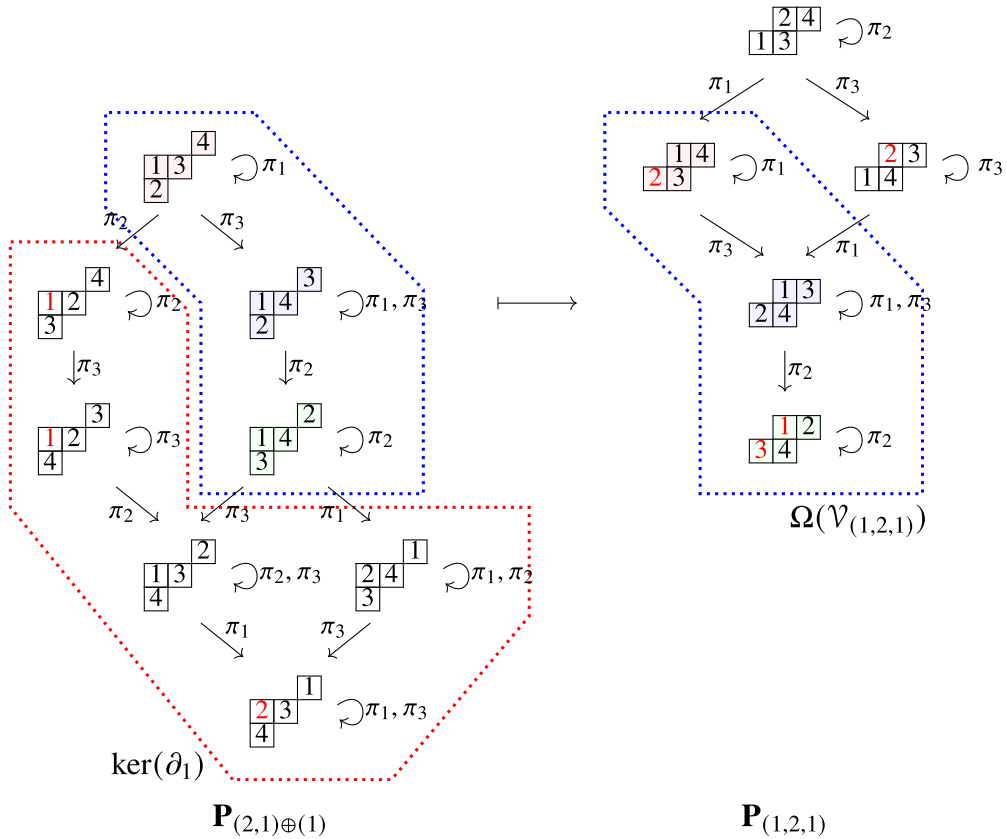

Figure 1. $\partial_1 : \mathbf{P}_{(2,1) \oplus (1)} \rightarrow \mathbf{P}_{(1,2,1)}$.

4. A minimal injective presentation of \mathcal{V}_α and $\text{Ext}_{H_n(0)}^1(\mathbf{F}_\beta, \mathcal{V}_\alpha)$

As before, α denotes an arbitrarily chosen composition of n . In this section, we construct a minimal injective presentation of \mathcal{V}_α . Using this, we compute $\text{Ext}_{H_n(0)}^1(\mathbf{F}_\beta, \mathcal{V}_\alpha)$ for each $\beta \vdash n$.

Let us introduce necessary terminologies and notation. Let M, N be finitely generated $H_n(0)$ -modules with $N \subseteq M$. We say that M is an *essential extension* of N if $X \cap N \neq 0$ for all nonzero submodules X of M . An injective $H_n(0)$ -module homomorphism $\iota : M \rightarrow \mathbf{I}$ with \mathbf{I} injective is called an *injective hull* of M if \mathbf{I} is an essential extension of $\iota(M)$ that always exists and is unique up to isomorphism. By [23, Theorem 3.30 and Exercise 3.6.12], it follows that \mathbf{I} is an injective hull of M if and only if $\iota(M) \supseteq \text{soc}(\mathbf{I})$. Here $\text{soc}(\mathbf{I})$ is the *socle* of \mathbf{I} : that is, the sum of all simple submodules of \mathbf{I} . When ι is clear in the context, we write $\Omega^{-1}(M)$ for $\text{Coker}(\iota)$ and call it the *cosyzygy module* of M . An exact sequence

$$0 \longrightarrow M \xrightarrow{\iota} \mathbf{I}_0 \xrightarrow{\partial^1} \mathbf{I}_1$$

with injective modules \mathbf{I}_0 and \mathbf{I}_1 is called a *minimal injective presentation* if the $H_n(0)$ -module homomorphisms $\iota : M \rightarrow \mathbf{I}_0$ and $\partial^1 : \Omega^{-1}(M) \rightarrow \mathbf{I}_1$ are injective hulls of M and $\Omega^{-1}(M)$, respectively.

We first describe an injective hull of \mathcal{V}_α . Let

$$\mathcal{K}(\alpha) := \{1 \leq i \leq \ell(\alpha) \mid \alpha_i > 1\} \cup \{0\}.$$

We write the elements of $\mathcal{K}(\alpha)$ as $k_0 := 0 < k_1 < k_2 < \dots < k_m$. Let

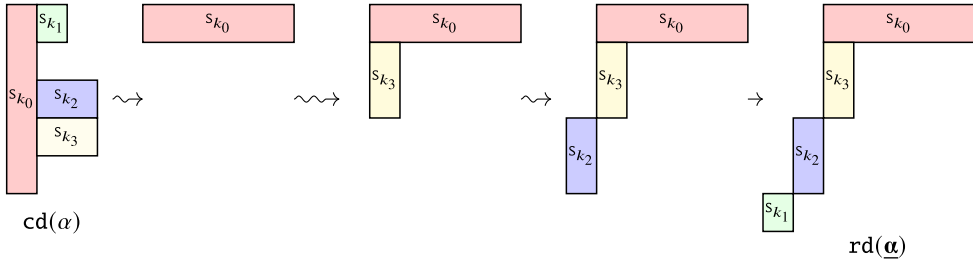

Figure 2. The construction of $\text{rd}(\underline{\alpha})$ when $\alpha = (2, 1, 3^2, 1)$.

$$\begin{aligned} \underline{\alpha} &:= (\alpha_{k_1} - 1) \oplus (\alpha_{k_2} - 1) \oplus \cdots \oplus \left((\alpha_{k_m} - 1) \odot (1^{\ell(\alpha)}) \right) \\ &= (\alpha_{k_1} - 1) \oplus (\alpha_{k_2} - 1) \oplus \cdots \oplus (\alpha_{k_{m-1}} - 1) \oplus (\alpha_{k_m}, 1^{\ell(\alpha)-1}). \end{aligned}$$

Let us depict $\text{rd}(\underline{\alpha})$ in a pictorial manner. When $j = 0$, we define S_{k_0} to be the vertical strip consisting of all the boxes in the first column of $\text{cd}(\alpha)$. For $1 \leq j \leq m$, we define S_{k_j} as the horizontal strip consisting of the boxes in the k_j th row of $\text{cd}(\alpha)$ (from the top), except for the leftmost box. Then $\underline{\alpha}$ is defined by the generalised composition obtained by placing $S_{k_0}, S_{k_1}, \dots, S_{k_m}$ in the following manner:

- (i) S_{k_0} is placed horizontally at the topmost row in the new diagram.
- (ii) S_{k_m} is placed vertically to the lower-left of S_{k_0} so that S_{k_0} and S_{k_m} are connected.
- (iii) For $j = m - 1, m - 2, \dots, 1$, place S_{k_j} vertically to the lower-left of $S_{k_{j+1}}$ so that they are not connected to each other.

Figure 2 illustrates the above procedure.

For simplicity, we introduce the following notation:

- For an SIT \mathcal{T} and a subdiagram S of shape of \mathcal{T} , we denote by $\mathcal{T}(S)$ the set of entries of \mathcal{T} in S .
- For an SRT T and a subdiagram S of shape of T , we denote by $T(S)$ the set of entries of T in S .

For $\mathcal{T} \in \text{SIT}(\alpha)$, let $T^{\mathcal{T}}$ be the tableau of $\text{rd}(\underline{\alpha})$ defined by

$$(T^{\mathcal{T}})(S_{k_j}) := \mathcal{T}(S_{k_j}) \quad \text{for } 0 \leq j \leq m.$$

Extending the assignment $\mathcal{T} \mapsto T^{\mathcal{T}}$ by linearity, we define the \mathbb{C} -linear map

$$\epsilon : \mathcal{V}_\alpha \rightarrow \mathbf{P}_{\underline{\alpha}}, \quad \mathcal{T} \mapsto T^{\mathcal{T}},$$

which is obviously injective.

Theorem 4.1 (This will be proven in Subsection 6.2). $\epsilon : \mathcal{V}_\alpha \rightarrow \mathbf{P}_{\underline{\alpha}}$ is an injective hull of \mathcal{V}_α .

For later use, we provide bases of $\epsilon(\mathcal{V}_\alpha)$ and $\Omega^{-1}(\mathcal{V}_\alpha)$. From the injectivity of ϵ , we derive that $\epsilon(\mathcal{V}_\alpha)$ is spanned by

$$\{T \in \text{SRT}(\underline{\alpha}) \mid T_j^{1+\delta_{j,m}} > T_{m+k_j-1}^1 \text{ for all } 1 \leq j \leq m\}$$

and $\Omega^{-1}(\mathcal{V}_\alpha)$ is spanned by $\{T + \epsilon(\mathcal{V}_\alpha) \mid T \in \Theta(\mathcal{V}_\alpha)\}$ with

$$\Theta(\mathcal{V}_\alpha) := \{T \in \text{SRT}(\underline{\alpha}) \mid T_j^{1+\delta_{j,m}} < T_{m+k_j-1}^1 \text{ for some } 1 \leq j \leq m\}. \tag{4.1}$$

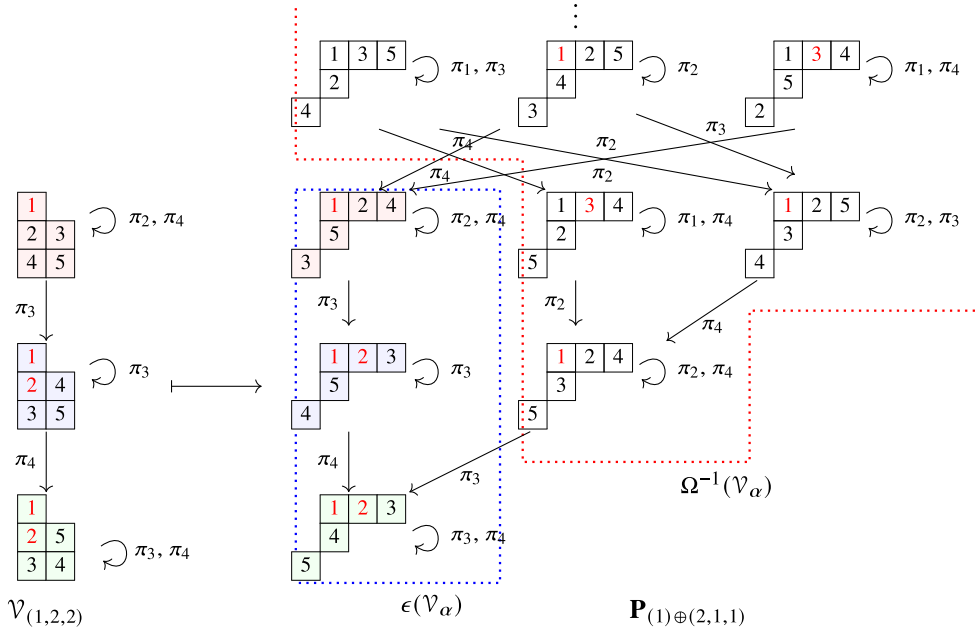

Figure 3. $\epsilon : \mathcal{V}_{(1,2,2)} \rightarrow \mathbf{P}_{(1) \oplus (2,1,1)}$.

Example 4.2. If $\alpha = (1, 2, 2) \models 5$, then $\mathcal{K}(\alpha) = \{0, 2, 3\}$ and $\underline{\alpha} = (1) \oplus (2, 1^2)$. For $\tau = \begin{matrix} 1 \\ 2 & 4 \\ 3 & 5 \end{matrix} \in \text{SIT}(\alpha)$,

one sees that $T^{\mathcal{F}} = \begin{matrix} 1 & 2 & 3 \\ 5 \\ 4 \end{matrix} \in \text{SRT}(\underline{\alpha})$. The map $\epsilon : \mathcal{V}_\alpha \rightarrow \mathbf{P}_{\underline{\alpha}}$ is illustrated in Figure 3, where the red entries i in tableaux are used to indicate that π_i acts on them as zero.

We next describe an injective hull of $\Omega^{-1}(\mathcal{V}_\alpha)$. To do this, we need an $H_n(0)$ -module homomorphism $\partial^1 : \mathbf{P}_{\underline{\alpha}} \rightarrow \mathbf{I}$ with \mathbf{I} an injective module satisfying that $\ker(\partial^1) = \epsilon(\mathcal{V}_\alpha)$.

First, we provide the required injective module \mathbf{I} . For $1 \leq j \leq m$, define $\underline{\alpha}_{(j)}$ to be the generalised composition

$$\underline{\alpha}_{(j)} := \begin{cases} (\alpha_{k_1} - 1) \oplus \cdots \oplus (\alpha_{k_j} - 2) \oplus \cdots \oplus (\alpha_{k_m}, 1^{\ell(\alpha) - k_j + 1}) \oplus (1^{k_j - 1}) & \text{if } 1 \leq j < m, \\ (\alpha_{k_1} - 1) \oplus \cdots \oplus (\alpha_{k_{m-1}} - 1) \oplus ((\alpha_{k_m} - 1, 1^{\ell(\alpha) - k_j + 1}) \cdot (1^{k_j - 1})) & \text{if } j = m. \end{cases}$$

Then we set

$$\mathbf{I} := \bigoplus_{1 \leq j \leq m} \mathbf{P}_{\underline{\alpha}_{(j)}}. \tag{4.2}$$

In the following, we provide a pictorial description of $\text{rd}(\underline{\alpha}_{(j)})$. We begin by recalling that $\text{rd}(\underline{\alpha})$ consists of the horizontal strip S_{k_0} and the vertical strips S_{k_1}, \dots, S_{k_m} . For each $-1 \leq r \leq m$, we denote by S'_{k_r} the connected horizontal strip of length

$$|S'_{k_r}| := \begin{cases} k_j - 1 & \text{if } r = -1, \\ \ell(\alpha) - k_j + 2 & \text{if } r = 0, \\ |S_{k_r}| - \delta_{r,j} & \text{if } 1 \leq r \leq m, \end{cases}$$

where $k_{-1} := -1$. With this preparation, $\underline{\alpha}_{(j)}$ is defined to be the generalised composition obtained by placing $S'_{k_{-1}}, S'_{k_0}, S'_{k_1}, \dots, S'_{k_m}$ in the following way:

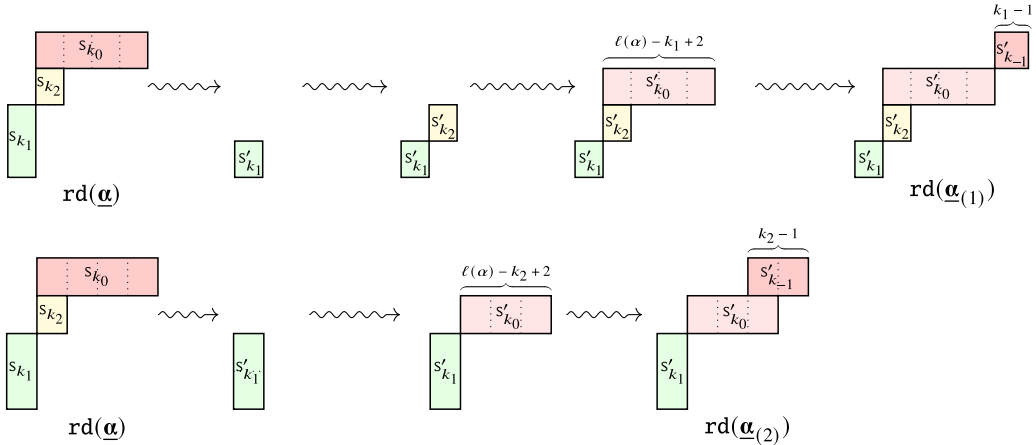

Figure 4. The construction of $\text{rd}(\underline{\alpha}_{(1)})$ and $\text{rd}(\underline{\alpha}_{(2)})$ when $\alpha = (1, 3, 2, 1)$.

- (i) S'_{k_1} is placed vertically to the leftmost column in the diagram we will create.
- (ii) For $j = 2, 3, \dots, m$, S'_{k_j} is placed vertically to the upper-right of $S'_{k_{j-1}}$ so that they are not connected to each other.
- (iii) S'_{k_0} is placed horizontally to S'_{k_m} so that they are connected.
- (iv) In the case where $j \neq m$, $S'_{k_{-1}}$ is placed horizontally to the upper-right of S'_{k_0} so that they are disconnected. In the case where $j = m$, $S'_{k_{-1}}$ is placed horizontally to the upper-right of S'_{k_0} so that they are connected.

Figure 4 illustrates the above procedure.

Now, let us construct $\partial^1 : \mathbf{P}_{\underline{\alpha}} \rightarrow \mathbf{I}$. Choose any tableau T in $\text{SRT}(\underline{\alpha})$. Recall that $\mathbf{w}(T)$ is the word obtained by reading the entries of T from left to right, starting with the bottom row. Let $\mathbf{w}(T) = w_1 w_2 \cdots w_n$. For each $1 \leq j \leq m$, we consider the subword $\mathbf{w}_{T;j}$ of $\mathbf{w}(T)$ defined by

$$\mathbf{w}_{T;j} := w_{u_1(j)} w_{u_2(j)} \cdots w_{u_j(j)}, \tag{4.3}$$

where the subscripts $u_i(j)$ s are defined via the following recursion:

$$u_1(j) = \sum_{1 \leq r \leq j} (\alpha_{k_r} - 1),$$

$$u_{i+1}(j) = \min\{u_i(j) < u \leq n - \ell(\alpha) \mid w_u < w_{u_i(j)}\} \quad (i \geq 1), \text{ and}$$

$$l_j := \max\{i \mid u_i(j) < \infty\}.$$

In the second identity, whenever $\{u_i(j) < u \leq n - \ell(\alpha) \mid w_u < w_{u_i(j)}\} = \emptyset$, we set $u_{i+1}(j) := \infty$. Henceforth we simply write u_i s for $u_i(j)$ s and thus $\mathbf{w}_{T;j} = w_{u_1} w_{u_2} \cdots w_{u_j}$. Given an arbitrary word w , we use $\text{end}(w)$ to denote the last letter of w . With the notations above, we introduce the following two sets:

$$\mathbf{A}_{T;j} := \{y \in T(S_{k_0}) \mid y > \text{end}(\mathbf{w}_{T;j})\},$$

$$\mathcal{P}(\mathbf{A}_{T;j}) := \{A \subseteq \mathbf{A}_{T;j} \mid |A| = \ell(\alpha) - k_j + 1\}.$$

For $A \in \mathcal{P}(\mathbf{A}_{T;j})$, we define $\tau_{T;j;A}$ to be an SRT of shape $\underline{\alpha}_{(j)}$ that is uniquely determined by the following conditions:

- (i) $\tau_{T;j;A}(S'_{k_{-1}}) = T(S_{k_0}) \setminus A$,
- (ii) $\tau_{T;j;A}(S'_{k_0}) = \{\text{end}(\mathbf{w}_{T;j})\} \cup A$,
- (iii) $\tau_{T;j;A}(S'_{k_r}) = T(S_{k_r})$ for $1 \leq r < j$,

- (iv) $\tau_{T;j;A}(S'_{k_j}) = T(S_{k_j}) \setminus \{w_{u_1}\}$, and
- (v) for $j < r \leq m$, $\tau_{T;j;A}(S'_{k_r})$ is obtained from $T(S_{k_r})$ by substituting w_{u_i} with $w_{u_{i-1}}$ for w_{u_i} ($1 < i \leq l_j$) contained in $T(S_{k_r})$.

We next explain the notion of the *signature* $\text{sgn}(A)$ of A . Enumerate the elements in $A_{T;j}$ in the increasing order

$$a_1 < a_2 < \dots < a_{|A_{T;j}|}.$$

Then let $A^1_{T;j}$ be the set of the consecutive $(\ell(\alpha) - k_j + 1)$ elements starting from the rightmost and moving to the left, precisely,

$$A^1_{T;j} = \{a_{|A_{T;j}| - \ell(\alpha) + k_j}, a_{|A_{T;j}| - \ell(\alpha) + k_j + 1}, \dots, a_{|A_{T;j}|}\}.$$

There is a natural right $\Sigma_{|A_{T;j}|}$ -action on $A_{T;j}$ given by

$$a_i \cdot \omega = a_{\omega^{-1}(i)} \text{ for } 1 \leq i \leq |A_{T;j}| \text{ and } \omega \in \Sigma_{|A_{T;j}|}. \tag{4.4}$$

We define $\text{sgn}(A) := (-1)^{\ell(\omega^1)}$, where ω^1 is any minimal length permutation in $\{\omega \in \Sigma_{|A_{T;j}|} \mid A = A^1_{T;j} \cdot \omega\}$.

For each $1 \leq j \leq m$, set

$$\tau_{T;j} := \sum_{A \in \mathcal{P}(A_{T;j})} \text{sgn}(A) \tau_{T;j;A},$$

where the summation in the right-hand side is zero in the case where $\mathcal{P}(A_{T;j}) = \emptyset$. Finally, we define a \mathbb{C} -linear map

$$\partial^1 : \mathbf{P}_{\underline{\alpha}} \rightarrow \mathbf{I}, \quad T \mapsto \sum_{1 \leq j \leq m} \tau_{T;j}$$

with \mathbf{I} in equation (4.2).

Theorem 4.3 (This will be proven in Subsection 6.3). *Let α be a composition of n .*

- (a) $\partial^1 : \mathbf{P}_{\underline{\alpha}} \rightarrow \mathbf{I}$ is an $H_n(0)$ -module homomorphism.
- (b) *The sequence*

$$\mathcal{V}_{\alpha} \xrightarrow{\epsilon} \mathbf{P}_{\underline{\alpha}} \xrightarrow{\partial^1} \mathbf{I}$$

is exact.

- (c) *The $H_n(0)$ -module homomorphism*

$$\overline{\partial^1} : \Omega^{-1}(\mathcal{V}_{\alpha}) \rightarrow \mathbf{I}, \quad T + \epsilon(\mathcal{V}_{\alpha}) \mapsto \partial^1(T) \quad (T \in \Theta(\mathcal{V}_{\alpha}))$$

induced from ∂^1 is an injective hull of $\Omega^{-1}(\mathcal{V}_{\alpha})$.

- (d) *Let $\mathcal{L}(\alpha) := \bigcup_{1 \leq j \leq m} [\underline{\alpha}_{(j)}]$, which is viewed as a multiset. Then we have*

$$\text{Ext}^1_{H_n(0)}(\mathbf{F}_{\beta}, \mathcal{V}_{\alpha}) \cong \begin{cases} \mathbb{C}^{[\mathcal{L}(\alpha) : \beta^r]} & \text{if } \beta^r \in \mathcal{L}(\alpha) \\ 0 & \text{otherwise,} \end{cases}$$

where $[\mathcal{L}(\alpha) : \beta^r]$ denotes the multiplicity of β^r in $\mathcal{L}(\alpha)$.

Example 4.4. Let $\alpha = (2, 1, 2, 3) \models 8$. Then $\mathcal{K}(\alpha) = \{0, 1, 3, 4\}$ and $\underline{\alpha} = (1) \oplus (1) \oplus (3, 1^3)$. By definition, we get

$$\begin{aligned} \underline{\alpha}_{(1)} &= (1) \oplus (3, 1^4), \\ \underline{\alpha}_{(2)} &= (1) \oplus (3, 1^2) \oplus (1^2), \\ \underline{\alpha}_{(3)} &= (1) \oplus (1) \oplus (2^2, 1^2). \end{aligned}$$

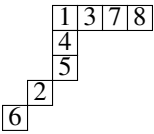
(a) Let $T =$ . Then one sees that

$$\begin{aligned} \mathbf{w}_{T;1} = 6 \quad 2 & \quad \text{end}(\mathbf{w}_{T;1}) = 2 \quad \mathbf{A}_{T;1} = \{3, 7, 8\} & \quad \mathcal{P}(\mathbf{A}_{T;1}) = \emptyset, \\ \mathbf{w}_{T;2} = 2 & \quad \text{end}(\mathbf{w}_{T;2}) = 2 \quad \mathbf{A}_{T;2} = \{3, 7, 8\} & \quad \mathcal{P}(\mathbf{A}_{T;2}) = \{\{3, 7\}, \{3, 8\}, \{7, 8\}\}, \\ \mathbf{w}_{T;3} = 4 & \quad \text{end}(\mathbf{w}_{T;3}) = 4 \quad \mathbf{A}_{T;3} = \{7, 8\} & \quad \mathcal{P}(\mathbf{A}_{T;3}) = \{\{7\}, \{8\}\}. \end{aligned}$$

Since

$$\begin{aligned} \tau_{T;2;\{3,7\}} &= \text{

it follows that$$

$$\tau_{T;1} = 0 \quad \tau_{T;2} = \tau_{T;2;\{3,7\}} - \tau_{T;2;\{3,8\}} + \tau_{T;2;\{7,8\}} \quad \tau_{T;3} = -\tau_{T;3;\{7\}} + \tau_{T;3;\{8\}}.$$

Therefore,

$$\partial^1(T) = (\tau_{T;2;\{3,7\}} - \tau_{T;2;\{3,8\}} + \tau_{T;2;\{7,8\}}) + (-\tau_{T;3;\{7\}} + \tau_{T;3;\{8\}}).$$

(b) Note that

$$\begin{aligned} [\underline{\alpha}_{(1)}] &= \{(1, 3, 1^4), (4, 1^4)\}, \\ [\underline{\alpha}_{(2)}] &= \{(1, 3, 1^4), (1, 3, 1, 2, 1), (4, 1^4), (4, 1, 2, 1)\}, \\ [\underline{\alpha}_{(3)}] &= \{(1^2, 2^2, 1^2), (1, 3, 2, 1^2), (2^3, 1^2), (4, 2, 1^2)\}. \end{aligned}$$

Theorem 4.3(d) implies that

$$\dim \text{Ext}_{H_n(0)}^1(\mathbf{F}_\beta, \mathcal{V}_\alpha) = \begin{cases} 1 & \text{if } \beta^r \in \mathcal{L}(\alpha) \setminus \{(1, 3, 1^4), (4, 1^4)\}, \\ 2 & \text{if } \beta^r \in \{(1, 3, 1^4), (4, 1^4)\}, \\ 0 & \text{otherwise.} \end{cases}$$

5. $\text{Ext}_{H_n(0)}^i(\mathcal{V}_\alpha, \mathcal{V}_\beta)$ with $i = 0, 1$

In the previous sections, we computed $\text{Ext}_{H_n(0)}^1(\mathcal{V}_\alpha, \mathbf{F}_\beta)$ and $\text{Ext}_{H_n(0)}^1(\mathbf{F}_\beta, \mathcal{V}_\alpha)$. In this section, we focus on $\text{Ext}_{H_n(0)}^1(\mathcal{V}_\alpha, \mathcal{V}_\beta)$ and $\text{Ext}_{H_n(0)}^0(\mathcal{V}_\alpha, \mathcal{V}_\beta) (= \text{Hom}_{H_n(0)}(\mathcal{V}_\alpha, \mathcal{V}_\beta))$.

Let M, N be finite-dimensional $H_n(0)$ -modules. Given a short exact sequence

$$0 \longrightarrow \Omega(M) \xrightarrow{\iota} P_0 \xrightarrow{\pi} M \longrightarrow 0$$

with (P_0, π) a projective cover of M , it is well known that

$$\text{Ext}_{H_n(0)}^1(M, N) \cong \frac{\text{Hom}_{H_n(0)}(\Omega(M), N)}{\text{Im } \iota^*},$$

where $\iota^* : \text{Hom}_{H_n(0)}(P_0, N) \rightarrow \text{Hom}_{H_n(0)}(\Omega(M), N)$ is given by composition with ι . The kernel of ι^* equals

$$\{f \in \text{Hom}_{H_n(0)}(P_0, N) \mid f|_{\Omega(M)} = 0\},$$

and therefore

$$\ker(\iota^*) \cong \text{Hom}_{H_n(0)}(P_0/\Omega(M), N) \cong \text{Hom}_{H_n(0)}(M, N). \tag{5.1}$$

This says that $\text{Ext}_{H_n(0)}^1(M, N) = 0$ if and only if, as \mathbb{C} -vector spaces,

$$\text{Hom}_{H_n(0)}(P_0, N) \cong \text{Hom}_{H_n(0)}(\Omega(M), N) \oplus \text{Hom}_{H_n(0)}(M, N). \tag{5.2}$$

Definition 5.1. Given a finite-dimensional $H_n(0)$ -module M , we say that M is *rigid* if $\text{Ext}_{H_n(0)}^1(M, M) = 0$ and *essentially rigid* if $\text{Hom}_{H_n(0)}(\Omega(M), M) = 0$.

Whenever M is essentially rigid, one has that $\text{Hom}_{H_n(0)}(P_0, M) \cong \text{End}_{H_n(0)}(M)$. Typical examples of essentially rigid $H_n(0)$ -modules are simple modules and projective modules. The syzygy and cosyzygy modules of a rigid module are also rigid since $\text{Ext}_{H_n(0)}^1(M, N) = \text{Ext}_{H_n(0)}^1(\Omega(M), \Omega(N))$ and $M \cong \Omega\Omega^{-1}(M) \oplus (\text{projective})$ (for example, see [3]).

Let us use \leq_l to represent the lexicographic order on compositions of n . Using the results in the preceding sections, we derive some interesting results on $\text{Ext}_{H_n(0)}^1(\mathcal{V}_\alpha, \mathcal{V}_\beta)$. To do this, we need the following lemmas.

Lemma 5.2 ([3, Lemma 1.7.6]). *Let M be a finite-dimensional $H_n(0)$ -module. Then $\dim \text{Hom}_{H_n(0)}(\mathbf{P}_\alpha, M)$ is the multiplicity of \mathbf{F}_α as a composition factors of M .*

Lemma 5.3 ([4, Proposition 3.37]). *The dual immaculate functions \mathfrak{S}_α^* are fundamental positive. Specifically, they expand as $\mathfrak{S}_\alpha^* = \sum_{\beta \leq_l \alpha} L_{\alpha, \beta} F_\beta$, where $L_{\alpha, \beta}$ denotes the number of standard immaculate tableaux \mathcal{T} of shape α and descent composition β : that is, $\text{comp}(\text{Des}(\mathcal{T})) = \beta$.*

We now state the main result of this section.

Theorem 5.4. *Let α be a composition of n .*

- (a) *For all $\beta \leq_l \alpha$, $\text{Ext}_{H_n(0)}^1(\mathcal{V}_\alpha, \mathcal{V}_\beta) = 0$. In particular, \mathcal{V}_α is essentially rigid.*
- (b) *For all $\beta \leq_l \alpha$, we have*

$$\text{Hom}_{H_n(0)}(\mathcal{V}_\alpha, \mathcal{V}_\beta) \cong \begin{cases} \mathbb{C} & \text{if } \beta = \alpha, \\ 0 & \text{otherwise.} \end{cases}$$

- (c) *Let M be any nonzero quotient of \mathcal{V}_α . Then $\text{End}_{H_n(0)}(M) \cong \mathbb{C}$.*

Proof. (a) Due to Theorem 3.3, there is a projective resolution of \mathcal{V}_α of the form

$$\cdots \longrightarrow \bigoplus_{i \in \mathcal{I}(\alpha)} \mathbf{P}_{\alpha^{(i)}} \longrightarrow \mathbf{P}_\alpha \longrightarrow \mathcal{V}_\alpha \longrightarrow 0.$$

Hence, for the assertion, it suffices to show that

$$\text{Hom}_{H_n(0)}\left(\bigoplus_{i \in \mathcal{I}(\alpha)} \mathbf{P}_{\alpha^{(i)}}, \mathcal{V}_\beta\right) = 0.$$

Observe that

$$\begin{aligned} \dim \text{Hom}_{H_n(0)}\left(\bigoplus_{i \in \mathcal{I}(\alpha)} \mathbf{P}_{\alpha^{(i)}}, \mathcal{V}_\beta\right) &= \sum_{\gamma \in \mathcal{J}(\alpha)} \dim \text{Hom}_{H_n(0)}(\mathbf{P}_\gamma, \mathcal{V}_\beta) \\ &= \sum_{\gamma \in \mathcal{J}(\alpha)} [\mathcal{V}_\beta : \mathbf{F}_\gamma] \quad (\text{by Lemma 5.2}). \end{aligned}$$

Here, $[\mathcal{V}_\beta : \mathbf{F}_\gamma]$ denotes the multiplicity of \mathbf{F}_γ as a composition factor of \mathcal{V}_β and thus equals the coefficient of F_γ in the expansion of \mathfrak{S}_β^* into fundamental quasisymmetric functions. From Lemma 5.3, it follows that this coefficient vanishes unless $\beta \geq_l \gamma$. Since $\alpha <_l \gamma$ for all $\gamma \in \mathcal{J}(\alpha)$, the assumption $\beta \leq_l \alpha$ yields the desired result.

(b) Combining equation (5.2) with (a) yields that

$$\text{Hom}_{H_n(0)}(\mathbf{P}_\alpha, \mathcal{V}_\beta) \cong \text{Hom}_{H_n(0)}(\Omega(\mathcal{V}_\alpha), \mathcal{V}_\beta) \oplus \text{Hom}_{H_n(0)}(\mathcal{V}_\alpha, \mathcal{V}_\beta).$$

But by Lemma 5.2 and Lemma 5.3, we see that

$$\dim \text{Hom}_{H_n(0)}(\mathbf{P}_\alpha, \mathcal{V}_\beta) = L_{\beta, \alpha} = \begin{cases} 1 & \text{if } \beta = \alpha \\ 0 & \text{otherwise.} \end{cases}$$

This justifies the assertion since $\dim \text{End}_{H_n(0)}(\mathcal{V}_\alpha) \geq 1$.

(c) Let $f : \mathbf{P}_\alpha \rightarrow M$ be a surjective $H_n(0)$ -module homomorphism. Then

$$\text{End}_{H_n(0)}(M) \cong \text{Hom}_{H_n(0)}(\mathbf{P}_\alpha / \ker(f), M),$$

and therefore

$$1 \leq \dim \text{End}_{H_n(0)}(M) \leq \dim \text{Hom}_{H_n(0)}(\mathbf{P}_\alpha, M) = [M : \mathbf{F}_\alpha].$$

Now the assertion follows from the inequality $[M : \mathbf{F}_\alpha] \leq [\mathcal{V}_\alpha : \mathbf{F}_\alpha] = L_{\alpha, \alpha} = 1$. □

Remark 5.5. To the best of the authors' knowledge, the classification or distribution of indecomposable rigid modules is completely unknown. For the reader's understanding, we provide some related examples.

- (a) Let $M := \mathbf{P}_{(1,2,2)}/H_5(0) \cdot \left\{ \begin{array}{|c|c|c|} \hline & & 4 \\ \hline 1 & 5 & \\ \hline 2 & 3 & \\ \hline \end{array} \right\}$. A simple computation shows that M is a rigid indecomposable module. But since $\dim \text{Hom}_{H_5(0)}(\Omega(M), M) = 1$, it is not essentially rigid.
- (b) Let $V := \mathbf{P}_{(1,2,2)}/H_5(0) \cdot \left\{ \begin{array}{|c|c|c|} \hline & & 3 \\ \hline 1 & 5 & \\ \hline 2 & 4 & \\ \hline \end{array} \right\}, \begin{array}{|c|c|c|} \hline & & 1 \\ \hline 3 & 4 & \\ \hline 2 & 5 & \\ \hline \end{array} \right\}$. By adding two V s appropriately, one can produce a nonsplit sequence

$$0 \longrightarrow V \longrightarrow M \longrightarrow V \longrightarrow 0.$$

Hence V is a nonrigid indecomposable module.

Theorem 5.4 (b) is no longer valid unless $\beta \leq_l \alpha$. In view of $\mathcal{V}_\alpha \cong \mathbf{P}_\alpha/\Omega(\mathcal{V}_\alpha)$, one can view $\text{Hom}_{H_n(0)}(\mathcal{V}_\alpha, \mathcal{V}_\beta)$ as the \mathbb{C} -vector space consisting of $H_n(0)$ -module homomorphisms from \mathbf{P}_α to \mathcal{V}_β that vanish on $\Omega(\mathcal{V}_\alpha)$. Therefore, to understand $\text{Hom}_{H_n(0)}(\mathcal{V}_\alpha, \mathcal{V}_\beta)$, it is indispensable to understand $\text{Hom}_{H_n(0)}(\mathbf{P}_\alpha, \mathcal{V}_\beta)$ first. To do this, let us fix a linear extension \leq_L^r of the partial order \leq^r on $\text{SIT}(\beta)$ given by

$$\tau' \leq_L^r \tau \quad \text{if and only if} \quad \tau' = \pi_\gamma \cdot \tau \text{ for some } \gamma \in \Sigma_n.$$

Given $f \in \text{Hom}_{H_n(0)}(\mathbf{P}_\alpha, \mathcal{V}_\beta)$, let $f(T_\alpha) = \sum_{\mathcal{T} \in \text{SIT}(\beta)} c_{f, \mathcal{T}} \mathcal{T}$. We define $\text{Lead}(f)$ to be the largest tableau in $\{\mathcal{T} \in \text{SIT}(\beta) : c_{f, \mathcal{T}} \neq 0\}$ with respect to \leq_L^r . When $f = 0$, $\text{Lead}(f)$ is set to be \emptyset .

Theorem 5.6. *Let α, β be compositions of n , and let \mathfrak{B} be the set of standard immaculate tableaux U of shape β with $\text{Des}(U) = \text{set}(\alpha)$.*

- (a) *For each standard immaculate tableau U of shape β with $\text{Des}(U) = \text{set}(\alpha)$, there exists a unique homomorphism $f_U \in \text{Hom}_{H_n(0)}(\mathbf{P}_\alpha, \mathcal{V}_\beta)$ such that $\text{Lead}(f) = U$, $c_{f, U} = 1$ and $c_{f, U'} = 0$ for all $U' \in \mathfrak{B} \setminus \{U\}$.*
- (b) *The dimension of $\text{Hom}_{H_n(0)}(\mathcal{V}_\alpha, \mathcal{V}_\beta)$ is the same as the dimension of*

$$\{(c_U)_{U \in \mathfrak{B}} \in \mathbb{C}^{|\mathfrak{B}|} : \sum_U c_U \pi_{[m_{i-1}+1, m_i]} \cdot f_U(T_\alpha) = 0 \text{ for all } i \in \mathcal{I}(\alpha)\}.$$

Proof. (a) Observe that every homomorphism in $\text{Hom}_{H_n(0)}(\mathbf{P}_\alpha, \mathcal{V}_\beta)$ is completely determined by the value at the source tableau T_α of \mathbf{P}_α . We claim that $\text{Des}(\text{Lead}(f)) = \text{set}(\alpha)$ for all nonzero $f \in \text{Hom}_{H_n(0)}(\mathbf{P}_\alpha, \mathcal{V}_\beta)$. To begin with, from the equalities $f(\pi_i \cdot T_\alpha) = f(T_\alpha)$ for all $i \notin \text{Des}(T_\alpha) = \text{set}(\alpha)$, we see that f satisfies the condition that $\text{Des}(\text{Lead}(f)) \subseteq \text{set}(\alpha)$. Recall that we set $m_i := \sum_{1 \leq k \leq i} \alpha_k$ for all $1 \leq i \leq \ell(\alpha)$ in Section 3. Suppose that there is an index j such that

$$m_j \in \text{set}(\alpha) \setminus \text{Des}(\text{Lead}(f)).$$

Then

$$m_{j-1} + 1, m_{j-1} + 2, \dots, m_{j+1} - 1 \in \text{set}(\alpha) \setminus \text{Des}(\text{Lead}(f)).$$

But this is absurd since

$$\pi_{[m_{j-1}+1, m_{j+1}-\alpha_j]}^r \cdots \pi_{[m_{j-1}, m_{j+1}-2]}^r \pi_{[m_j, m_{j+1}-1]}^r \cdot T_\alpha = 0,$$

whereas

$$\pi_{[m_{j-1}+1, m_{j+1}-\alpha_j]}^r \cdots \pi_{[m_{j-1}, m_{j+1}-2]}^r \pi_{[m_j, m_{j+1}-1]}^r \cdot \text{Lead}(f) = \text{Lead}(f).$$

So the claim is verified.

For each $U \in \mathfrak{B}$, consider the \mathbb{C} -vector space

$$H(U) := \{f \in \text{Hom}_{H_n(0)}(\mathbf{P}_\alpha, \mathcal{V}_\beta) : \text{Lead}(f) \leq_L^r U\}.$$

Write \mathfrak{B} as $\{U_1 \leq_L^r U_2 \leq_L^r \cdots \leq_L^r U_{l-1} \leq_L^r U_l\}$, where $l = |\mathfrak{B}|$. For any $f, g \in H(U_i)$, it holds that

$$c_{g, \text{Lead}(g)} f - c_{f, \text{Lead}(f)} g \in H(U_{i-1})$$

with $H(U_0) := 0$. This implies that $\dim H(U_i)/H(U_{i-1}) \leq 1$ for all $1 \leq i \leq l$.

Combining these inequalities with the equality $\dim \text{Hom}_{H_n(0)}(\mathbf{P}_\alpha, \mathcal{V}_\beta) = |\mathfrak{B}|$, we deduce that, for each $U \in \mathfrak{B}$, there exists a unique $f_U \in \text{Hom}_{H_n(0)}(\mathbf{P}_\alpha, \mathcal{V}_\beta)$ with the desired property.

(b) By (a), one sees that $\{f_U : U \in \mathfrak{B}\}$ forms a basis for $\text{Hom}_{H_n(0)}(\mathbf{P}_\alpha, \mathcal{V}_\beta)$. Since $\text{Hom}_{H_n(0)}(\mathcal{V}_\alpha, \mathcal{V}_\beta)$ is isomorphic to the \mathbb{C} -vector space consisting of $H_n(0)$ -module homomorphisms from \mathbf{P}_α to \mathcal{V}_β which

vanish on $\Omega(\mathcal{V}_\alpha)$, our assertion follows from Lemma 6.2, which says that $\{\pi_{[m_{i-1}+1, m_i]} \cdot T_\alpha : i \in \mathcal{I}(\alpha)\}$ is a generating set of $\Omega(\mathcal{V}_\alpha)$. □

Example 5.7. (a) Let $\alpha = (1, 1, 2, 1)$ and $\beta = (1, 2, 2)$. Then $\mathfrak{B} = \{U := \begin{bmatrix} 1 & & & \\ & 2 & 4 & \\ & 3 & 5 & \end{bmatrix}\}$ and

$$f_U(T_\alpha) = \begin{bmatrix} 1 & & & \\ & 2 & 4 & \\ & 3 & 5 & \end{bmatrix} - \begin{bmatrix} 1 & & & \\ & 2 & 5 & \\ & 3 & 4 & \end{bmatrix}.$$

Note that $\mathcal{I}(\alpha) = \{2\}$ and $m_1 = 1, m_2 = 2$. Since $\pi_2 \cdot f_U(T_\alpha) = 0$, it follows that $\text{Hom}_{H_n(0)}(\mathcal{V}_\alpha, \mathcal{V}_\beta)$ is 1-dimensional.

(b) Let $\alpha = (1, 1, 3, 2)$ and $\beta = (2, 3, 2)$. Then

$$\mathfrak{B} = \left\{ U_1 := \begin{bmatrix} 1 & 5 & & \\ & 2 & 4 & 7 \\ & 3 & 6 & \end{bmatrix}, U_2 := \begin{bmatrix} 1 & 7 & & \\ & 2 & 4 & 5 \\ & 3 & 6 & \end{bmatrix}, U_3 := \begin{bmatrix} 1 & 5 & & \\ & 2 & 6 & 7 \\ & 3 & 4 & \end{bmatrix} \right\}$$

and $f_{U_i}(T_\alpha) = U_i$ for $i = 1, 2, 3$. Note that $\mathcal{I}(\alpha) = \{2, 3\}$ and $m_1 = 1, m_2 = 2, m_3 = 5$. Since $\pi_2 \cdot f_{U_i}(T_\alpha) = 0$ for all $1 \leq i \leq 3$ and

$$\pi_{[3,5]} \cdot (c_1 f_{U_1}(T_\alpha) + c_2 f_{U_2}(T_\alpha) + c_3 f_{U_3}(T_\alpha)) = (c_1 + c_3) \begin{bmatrix} 1 & 6 & & \\ & 2 & 5 & 7 \\ & 3 & 4 & \end{bmatrix} + c_2 \begin{bmatrix} 1 & 7 & & \\ & 2 & 5 & 6 \\ & 3 & 4 & \end{bmatrix},$$

it follows that $\text{Hom}_{H_n(0)}(\mathcal{V}_\alpha, \mathcal{V}_\beta)$ is 1-dimensional.

We end up with an interesting consequence of Theorem 4.3, where we successfully compute $\text{Ext}_{H_n(0)}^1(\mathbf{F}_\beta, \mathcal{V}_\alpha)$ by constructing an injective hull of $\Omega^{-1}(\mathcal{V}_\alpha)$. To compute it in a different way, let us consider a short exact sequence

$$0 \longrightarrow \text{rad}(\mathbf{P}_\beta) \xrightarrow{\iota} \mathbf{P}_\beta \xrightarrow{\text{pr}} \mathbf{F}_\beta \longrightarrow 0.$$

Here, ι is the natural injection. Then we have

$$\text{Ext}_{H_n(0)}^1(\mathbf{F}_\beta, \mathcal{V}_\alpha) \cong \frac{\text{Hom}_{H_n(0)}(\text{rad}(\mathbf{P}_\beta), \mathcal{V}_\alpha)}{\text{Im } \iota^*}, \tag{5.3}$$

where $\iota^* : \text{Hom}_{H_n(0)}(\mathbf{P}_\beta, \mathcal{V}_\alpha) \rightarrow \text{Hom}_{H_n(0)}(\text{rad}(\mathbf{P}_\beta), \mathcal{V}_\alpha)$ is given by composition by with ι . By equation (5.1), one has that

$$\begin{aligned} \dim \text{Im } \iota^* &= \dim \text{Hom}_{H_n(0)}(\mathbf{P}_\beta, \mathcal{V}_\alpha) - \dim \text{Hom}_{H_n(0)}(\mathbf{F}_\beta, \mathcal{V}_\alpha) \\ &= [\mathcal{V}_\alpha : \mathbf{F}_\beta] - [\text{soc}(\mathcal{V}_\alpha) : \mathbf{F}_\beta] \\ &= L_{\alpha, \beta} - [[\underline{\alpha}] : \beta^f] \quad (\text{by Lemma 5.3 and Theorem 4.1}), \end{aligned}$$

where $[[\underline{\alpha}] : \beta^f]$ is the multiplicity of $\beta^f \in [\underline{\alpha}]$. Comparing Theorem 4.3 with equation (5.3) yields the following result.

Corollary 5.8. *Let α, β be compositions of n . Then we have*

$$\dim \text{Hom}_{H_n(0)}(\text{rad}(\mathbf{P}_\beta), \mathcal{V}_\alpha) = L_{\alpha, \beta} - [[\underline{\alpha}] : \beta^f] + [\mathcal{L}(\alpha) : \beta^f].$$

6. Proof of Theorems

6.1. Proof of Theorem 3.3

We first prove that $\Omega(\mathcal{V}_\alpha)$ is generated by $\{T_\alpha^{(i)} \mid i \in \mathcal{I}(\alpha)\}$. By the definition of Φ , one can easily derive that

$$\Omega(\mathcal{V}_\alpha) = \mathbb{C}\{T \in \text{SRT}(\alpha) \mid T_p^1 > T_{p+1}^1 \text{ for some } 1 \leq p < \ell(\alpha)\}.$$

Given $\sigma \in \Sigma_n$, let

$$\text{Des}_L(\sigma) := \{i \in [n - 1] \mid \ell(s_i\sigma) < \ell(\sigma)\} \text{ and } \text{Des}_R(\sigma) := \{i \in [n - 1] \mid \ell(\sigma s_i) < \ell(\sigma)\}.$$

The *left weak Bruhat order* \leq_L on Σ_n is the partial order on Σ_n whose covering relation \leq_L^c is defined as follows: $\sigma \leq_L^c s_i\sigma$ if and only if $i \notin \text{Des}_L(\sigma)$. It should be remarked that a word of length n can be confused with a permutation in Σ_n if each of $1, 2, \dots, n$ appears in it exactly once.

The following lemma plays a key role in proving Lemma 6.2.

Lemma 6.1 ([8, Proposition 3.1.2 (vi)]). *Suppose that $i \in \text{Des}_R(\sigma) \cap \text{Des}_R(\rho)$. Then $\sigma \leq_L \rho$ if and only if $\sigma s_i \leq_L \rho s_i$.*

Lemma 6.2. *For each $i \in \mathcal{I}(\alpha)$, $H_n(0) \cdot T_\alpha^{(i)} = \mathbb{C}\{T \in \text{SRT}(\alpha) \mid T_i^1 > T_{i+1}^1\}$. Thus, $\Omega(\mathcal{V}_\alpha) = \sum_{i \in \mathcal{I}(\alpha)} H_n(0) \cdot T_\alpha^{(i)}$.*

Proof. For simplicity, let $\text{SRT}(\alpha)^{(i)}$ be the set of SRTx of shape α such that the topmost entry in the i th column is greater than that in the $(i + 1)$ st column.

We first show that $H_n(0) \cdot T_\alpha^{(i)}$ is included in the \mathbb{C} -span of $\text{SRT}(\alpha)^{(i)}$, equivalently $\pi_\sigma \cdot T_\alpha^{(i)} \in \text{SRT}(\alpha)^{(i)} \cup \{0\}$ for all $\sigma \in \Sigma_n$. Suppose that there exists $\sigma \in \Sigma_n$ such that $\pi_\sigma \cdot T_\alpha^{(i)} \neq 0$ and $\pi_\sigma \cdot T_\alpha^{(i)} \notin \text{SRT}(\alpha)^{(i)}$. Let σ_0 be such a permutation with minimal length and j a left descent of σ_0 . By the minimality of σ_0 , we have $\pi_{s_j\sigma_0} \cdot T_\alpha^{(i)} \in \text{SRT}(\alpha)^{(i)}$, and therefore

$$(\pi_{s_j\sigma_0} \cdot T_\alpha^{(i)})_i^1 > (\pi_{s_j\sigma_0} \cdot T_\alpha^{(i)})_{i+1}^1.$$

By the definition of the π_j -action on $\text{SRT}(\alpha)$, we have

$$(\pi_j \cdot (\pi_{s_j\sigma_0} \cdot T_\alpha^{(i)}))_i^1 > (\pi_j \cdot (\pi_{s_j\sigma_0} \cdot T_\alpha^{(i)}))_{i+1}^1.$$

However, since $\pi_j \cdot (\pi_{s_j\sigma_0} \cdot T_\alpha^{(i)}) = \pi_{\sigma_0} \cdot T_\alpha^{(i)}$, this contradicts the assumption that $\pi_{\sigma_0} \cdot T_\alpha^{(i)} \notin \text{SRT}(\alpha)^{(i)}$.

We next show the opposite inclusion $\text{SRT}(\alpha)^{(i)} \subseteq H_n(0) \cdot T_\alpha^{(i)}$. Our strategy is to use [20, Theorem 3.3], which implicitly says that for $T_1, T_2 \in \text{SRT}(\alpha)$, $T_2 \in H_n(0) \cdot T_1$ if and only if $\mathbf{w}(T_1) \leq_L \mathbf{w}(T_2)$. Here, $\mathbf{w}(T_i)$ ($i = 1, 2$) denotes the word obtained from T_i by reading the entries from left to right starting with the bottom row. For each $T \in \text{SRT}(\alpha)^{(i)}$, we define τ_T to be the filling of $\text{rd}(\alpha^{(i)})$ whose entries in each column are increasing from top to bottom and whose columns are given as follows: for $1 \leq p \leq \ell(\alpha)$,

$$(\tau_T)_p^\bullet = \begin{cases} T_i^\bullet \cup \{T_{i+1}^1\} & \text{if } p = i, \\ T_{i+1}^\bullet \setminus \{T_{i+1}^1\} & \text{if } p = i + 1, \\ T_p^\bullet & \text{otherwise.} \end{cases} \tag{6.1}$$

The inequality $(\tau_T)_i^1 < (\tau_T)_{i+1}^{-1}$ shows that $\tau_T \in \text{SRT}(\alpha^{(i)})$. Combining

$$\mathbf{w}(\tau_T) = \mathbf{w}(T) s_{m_{i+1}-1} s_{m_{i+1}-2} \cdots s_{m_i}$$

with $\tau_{T_\alpha^{(i)}} = T_{\alpha^{(i)}}$ (=the source tableau of $\mathbf{P}_{\alpha^{(i)}}$) yields that $\mathbf{w}(\tau_{T_\alpha^{(i)}}) \leq_L \mathbf{w}(\tau_T)$ for $T \in \text{SRT}(\alpha)^{(i)}$. Moreover, for each $m_i \leq j < m_{i+1}$, it holds that

$$s_j \in \text{Des}_R(\mathbf{w}(\tau_{T_\alpha^{(i)}})s_{m_i}s_{m_i+1} \cdots s_{j-1}) \cap \text{Des}_R(\mathbf{w}(\tau_T)s_{m_i}s_{m_i+1} \cdots s_{j-1}). \tag{6.2}$$

Here, $s_{m_i}s_{m_i+1} \cdots s_{j-1}$ is regarded as the identity when $j = m_i$. Finally, applying Lemma 6.1 to equation (6.2) yields that $\mathbf{w}(T_\alpha^{(i)}) \leq_L \mathbf{w}(T)$, as required. \square

Combining Lemma 6.2 with the equalities $L(\tau)_i^1 = \tau_i^2$ and $L(\tau)_{i+1}^1 = \min(\tau_i^1, \tau_{i+1}^1)$, we derive that $\partial_1^{(i)}$ is well-defined.

Lemma 6.3. For $i \in \mathcal{I}(\alpha)$, $\partial_1^{(i)} : \mathbf{P}_{\alpha^{(i)}} \rightarrow H_n(0) \cdot T_\alpha^{(i)}$ is a surjective $H_n(0)$ -module homomorphism.

Proof. For each $T \in H_n(0) \cdot T_\alpha^{(i)}$, let τ_T be the filling of $\text{rd}(\alpha^{(i)})$ defined in equation (6.1). The surjectivity of $\partial_1^{(i)}$ is straightforward since $\tau_T \in \text{SRT}(\alpha^{(i)})$ and $L(\tau_T) = T$. Thus, to prove our assertion, it suffices to show that

$$\partial_1^{(i)}(\pi_k \cdot \tau) = \pi_k \cdot \partial_1^{(i)}(\tau)$$

for all $k = 1, 2, \dots, n - 1$ and $\tau \in \text{SRT}(\alpha^{(i)})$.

Case 1: $\pi_k \cdot \tau = \tau$. If $\partial_1^{(i)}(\tau) = 0$, then there is nothing to prove. Suppose that $\partial_1^{(i)}(\tau) \neq 0$: that is, $L(\tau) \in \text{SRT}(\alpha)$. We claim that $k \notin \text{Des}(L(\tau))$. If $k = \tau_i^1$ and $k + 1 = \tau_i^2$, then $k \in L(\tau)_{i+1}^\bullet$ and $k + 1 \in L(\tau)_i^\bullet$. If $k \in \tau_{i+1}^\bullet$ and $k + 1 = \tau_i^1$, then both k and $k + 1$ are in $L(\tau)_{i+1}^\bullet$. In the remaining cases, from the fact that k is weakly right of $k + 1$ in τ , it follows that k is weakly right of $k + 1$ in $L(\tau)$. For any cases, we can see that $k \notin \text{Des}(L(\tau))$.

Case 2: $\pi_k \cdot \tau = 0$. If $\partial_1^{(i)}(\tau) = 0$, then there is nothing to prove. Suppose that $\partial_1^{(i)}(\tau) \neq 0$. Since k and $k + 1$ are in the same row of τ , k is the top and $k + 1$ is the bottom for some two consecutive columns of τ . If $k \neq \tau_i^1$, then k and $k + 1$ are still in the same row of $L(\tau)$, so $\pi_k \cdot L(\tau) = \pi_k \cdot \partial_1^{(i)}(\tau) = 0$, as required. Assume that $k = \tau_i^1$. Note that $|\tau_i^\bullet| = \alpha_i + 1 \geq 2$ and τ_i^2 greater than both k and $k + 1$. By the definition of $L(\tau)$, we have that $L(\tau)_i^1 = \tau_i^2 > L(\tau)_{i+1}^{-1} = k + 1$. This implies that $\partial_1^{(i)}(\tau) = 0$, which contradicts our assumption $\partial_1^{(i)}(\tau) \neq 0$.

Case 3: $\pi_k \cdot \tau = s_k \cdot \tau$. First, consider the case where $\partial_1^{(i)}(\tau) = 0$: that is, $L(\tau) \notin \text{SRT}(\alpha)$. Then τ must satisfy either $\tau_i^2 > \tau_{i+1}^{-1}$ or $\min(\tau_i^1, \tau_{i+1}^1) > \tau_{i+2}^{-1}$. Thus, to $L(\pi_k \cdot \tau) \in \text{SRT}(\alpha)$, either $\tau_i^2 = k + 1$ and $\tau_{i+1}^{-1} = k$ or $\min(\tau_i^1, \tau_{i+1}^1) = k + 1$ and $\tau_{i+2}^{-1} = k$. However, these are absurd because k is strictly left of $k + 1$ in τ .

Next, consider the case where $\partial_1^{(i)}(\tau) \neq 0$: that is, $L(\tau) \in \text{SRT}(\alpha)$. Since $\pi_k \cdot \tau = s_k \cdot \tau$, k is strictly left of $k + 1$ in τ . Therefore, k is weakly left of $k + 1$ in $L(\tau)$ by the definition of $L(\tau)$. Hence if neither k and $k + 1$ are in the same column in $L(\tau)$, nor are they in the same row in $L(\tau)$, then $\pi_k \cdot L(\tau) = s_k \cdot L(\tau)$. Therefore, in such case, we have that

$$\pi_k \cdot \partial_1^{(i)}(\tau) = \pi_k \cdot L(\tau) = s_k \cdot L(\tau) = L(s_k \cdot \tau) = L(\pi_k \cdot \tau) = \partial_1^{(i)}(\pi_k \cdot \tau).$$

Suppose that k and $k + 1$ are in the same column in $L(\tau)$. This is possible only the case where $k = \tau_i^1$ and $k + 1 \in \tau_{i+1}^\bullet$ since k is strictly left of $k + 1$ in τ . Moreover, $k + 1 \neq \tau_{i+1}^{-1}$ since $\pi_k \cdot \tau = s_k \cdot \tau$. Hence $k + 1 = (\pi_k \cdot \tau)_i^1$ and $k \in (\pi_k \cdot \tau)_{i+1}^\bullet$, which implies that $L(\tau) = L(\pi_k \cdot \tau)$. Therefore, we have

$$\pi_k \cdot \partial_1^{(i)}(\tau) = \pi_k \cdot L(\tau) = L(\tau) = L(\pi_k \cdot \tau) = \partial_1^{(i)}(\pi_k \cdot \tau).$$

Here the second equality follows from the assumption that k and $k + 1$ are in the same column in $L(\tau)$.

Suppose that k and $k + 1$ are in the same row in $L(\tau)$. Then $\pi_k \cdot L(\tau) = 0$. In addition, since $\pi_k \cdot \tau = s_k \cdot \tau$, we have that either $L(\tau)_{i+1}^1 = k$ and $L(\tau)_{i+2}^{-1} = k + 1$, or $L(\tau)_i^1 = k$ and $L(\tau)_{i+1}^{-1} = k + 1$.

In the case where $L(\tau)_{i+1}^1 = k$ and $L(\tau)_{i+2}^{-1} = k + 1$, the assumption $\pi_k \cdot \tau = s_k \cdot \tau$ implies that $L(\pi_k \cdot \tau)_{i+1}^1 = k + 1$ and $L(\pi_k \cdot \tau)_{i+2}^{-1} = k$. Thus, $L(\pi_k \cdot \tau) \notin \text{SRT}(\alpha)$: that is, $\partial_1^{(i)}(\pi_k \cdot \tau) = 0$ as desired. In the case where $L(\tau)_i^1 = k$ and $L(\tau)_{i+1}^{-1} = k + 1$, one can easily see that $L(\pi_k \cdot \tau) \notin \text{SRT}(\alpha)$. Thus $\pi_k \cdot \partial_1^{(i)}(\tau) = 0 = \partial_1^{(i)}(\pi_k \cdot \tau)$. □

Due to Lemma 6.2 and Lemma 6.3, we can view $\partial_1 = \sum_{i \in \mathcal{I}(\alpha)} \partial_1^{(i)}$ as an $H_n(0)$ -module homomorphism from $\bigoplus_{i \in \mathcal{I}(\alpha)} \mathbf{P}_{\alpha^{(i)}}$ onto $\Omega(\mathcal{V}_\alpha)$. Now, we verify that ∂_1 is an essential epimorphism: that is, $\ker(\partial_1) \subseteq \text{rad}(\bigoplus_{i \in \mathcal{I}(\alpha)} \mathbf{P}_{\alpha^{(i)}})$.

To ease notation, we write $\tau_{(i)}$ for the source tableau $\tau_{\alpha^{(i)}}$ in $\text{SRT}(\alpha^{(i)})$. When $i \neq \ell(\alpha) - 1$, we can see that

$$\begin{aligned} (\tau_{(i)})_{i+1}^q &= m_i + 1 + q \quad \text{for } 1 \leq q \leq \alpha_{i+1} - 1, \text{ and} \\ (\tau_{(i)})_{i+2}^q &= m_{i+1} + q \quad \text{for } 1 \leq q \leq \alpha_{i+2}, \end{aligned}$$

where $m_i = \sum_{j=1}^i \alpha_j$. Let $\hat{\tau}_{(i)}$ denote the SRT of shape $\alpha^{(i)}$ such that

$$\begin{aligned} (\hat{\tau}_{(i)})_{i+1}^q &= m_i + 1 + \alpha_{i+2} + q \quad \text{for } 1 \leq q \leq \alpha_{i+1} - 1, \\ (\hat{\tau}_{(i)})_{i+2}^q &= m_i + 1 + q \quad \text{for } 1 \leq q \leq \alpha_{i+2}, \text{ and} \\ (\hat{\tau}_{(i)})_p &= (\tau_{(i)})_p \quad \text{for } p \neq i, i + 1. \end{aligned}$$

For example, if $\alpha = (1, 3, 3, 1)$ and $i = 1$, then

$$\tau_{(i)} = \begin{array}{c} \boxed{5} \boxed{8} \\ \boxed{6} \\ \boxed{7} \\ \boxed{3} \\ \boxed{1} \boxed{4} \\ \boxed{2} \end{array} \quad \text{and} \quad \hat{\tau}_{(i)} = \begin{array}{c} \boxed{3} \boxed{8} \\ \boxed{4} \\ \boxed{5} \\ \boxed{6} \\ \boxed{1} \boxed{7} \\ \boxed{2} \end{array}.$$

Observe that $(\tau_{(i)})_j^\bullet = (\hat{\tau}_{(i)})_j^\bullet$ for $j \neq i + 1, i + 2$.

Lemma 6.4. For $i \in \mathcal{I}(\alpha)$, $\ker(\partial_1^{(i)}) \subseteq \text{rad}(\mathbf{P}_{\alpha^{(i)}})$.

Proof. If $i = \ell(\alpha) - 1$, then $\alpha^{(i)}$ is a composition. Therefore, $\text{rad}(\mathbf{P}_{\alpha^{(i)}})$ is the \mathbb{C} -span of $\text{SRT}(\alpha^{(i)}) \setminus \{\tau_{(i)}\}$. Since $\partial_1^{(i)}(\tau_{(i)}) \neq 0$, this implies that $\ker(\partial_1^{(i)}) \subseteq \text{rad}(\mathbf{P}_{\alpha^{(i)}})$.

Suppose that $i \neq \ell(\alpha) - 1$. Let

$$\begin{aligned} \beta^{(1)} &= (\alpha_1, \alpha_2, \dots, \alpha_{i-1}, \alpha_i + 1, \alpha_{i+1} - 1, \alpha_{i+2}, \alpha_{i+3}, \dots, \alpha_{\ell(\alpha)}), \\ \beta^{(2)} &= (\alpha_1, \alpha_2, \dots, \alpha_{i-1}, \alpha_i + 1, \alpha_{i+1} - 1 + \alpha_{i+2}, \alpha_{i+3}, \dots, \alpha_{\ell(\alpha)}). \end{aligned} \tag{6.3}$$

To ease notation, we denote the source tableaux of $\mathbf{P}_{\beta^{(1)}}$ and $\mathbf{P}_{\beta^{(2)}}$ by $\tau^{(1)}$ and $\tau^{(2)}$, respectively. By Theorem 2.3, we may choose an $H_n(0)$ -module isomorphism

$$f : \mathbf{P}_{\alpha^{(i)}} \rightarrow \mathbf{P}_{\beta^{(1)}} \oplus \mathbf{P}_{\beta^{(2)}}.$$

Let

$$f(\tau_{(i)}) = \sum_{\tau \in \text{SRT}(\beta^{(1)})} c_\tau \tau + \sum_{\tau \in \text{SRT}(\beta^{(2)})} d_\tau \tau \quad \text{for } c_\tau, d_\tau \in \mathbb{C}.$$

Since $f(\tau_{(i)})$ is a generator of $\mathbf{P}_{\beta^{(1)}} \oplus \mathbf{P}_{\beta^{(2)}}$, $c_{\tau^{(1)}}$ and $d_{\tau^{(2)}}$ are nonzero.

We claim that $[\tau_{(i)}, \hat{\tau}_{(i)}]^c \subseteq \text{rad}(\mathbf{P}_{\alpha^{(i)}})$. Take any $\tau \notin [\tau_{(i)}, \hat{\tau}_{(i)}]$. To get τ from $\tau_{(i)}$, there should exist an $H_n(0)$ -action switching two entries such that at least one of them lies apart from the $(i + 1)$ st and $(i + 2)$ nd columns. Thus there exist $\sigma, \rho \in \Sigma_n$ and $k \notin [m_i + 2, m_{i+2} - 1]$ such that

$$\tau = \pi_\sigma \pi_k \pi_\rho \cdot \tau_{(i)}, \quad \pi_\rho \cdot \tau_{(i)} \in [\tau_{(i)}, \hat{\tau}_{(i)}] \quad \text{and} \quad \pi_k \pi_\rho \cdot \tau_{(i)} = s_k \cdot (\pi_\rho \cdot \tau_{(i)}).$$

Ignoring the columns filled with entries $[m_i + 2, m_{i+2}]$, we can see that all $\pi_\rho \cdot \tau_{(i)}$, $\tau^{(1)}$ and $\tau^{(2)}$ are the same. This implies that $\pi_k \cdot \tau^{(j)} = s_k \cdot \tau^{(j)}$ for $j = 1, 2$. In all, we have

$$\begin{aligned} f(\tau) &= \pi_\sigma \pi_k \pi_\rho \cdot f(\tau_{(i)}) \\ &= \pi_\sigma \pi_k \pi_\rho \cdot \left(\sum_{\tau \in \text{SRT}(\beta^{(1)})} c_\tau \tau + \sum_{\tau \in \text{SRT}(\beta^{(2)})} d_\tau \tau \right) \\ &= \sum_{\substack{\tau \in \text{SRT}(\beta^{(1)}) \\ \tau > \tau^{(1)}}} c'_\tau \tau + \sum_{\substack{\tau \in \text{SRT}(\beta^{(2)}) \\ \tau > \tau^{(2)}}} d'_\tau \tau \end{aligned}$$

for some $c'_\tau, d'_\tau \in \mathbb{C}$. This implies that $f(\tau) \in \text{rad}(\mathbf{P}_{\beta^{(1)}} \oplus \mathbf{P}_{\beta^{(2)}})$, and hence $\tau \in \text{rad}(\mathbf{P}_{\alpha^{(i)}})$.

By virtue of the above discussion, to complete our assertion, it is enough to show that $\ker(\partial_1^{(i)}) \subseteq \mathbb{C}[\tau_{(i)}, \hat{\tau}_{(i)}]^c$, or equivalently, $L(\tau) \in \text{SRT}(\alpha)$ for every $\tau \in [\tau_{(i)}, \hat{\tau}_{(i)}]$. But this is obvious since $L(\tau)_i^1 = \tau_i^2 = m_{i-1} + 2$, $L(\tau)_{i+1}^1 = \tau_i^1 = m_{i-1} + 1$ and $L(\tau)_{i+1}^{-1}, L(\tau)_{i+2}^{-1} \in [m_i + 2, m_{i+2}]$. \square

We are now in place to prove Theorem 3.3.

Proof of Theorem 3.3. (a) As mentioned after the proof of Lemma 6.3, $\partial_1 : \bigoplus_{i \in \mathcal{I}(\alpha)} \mathbf{P}_{\alpha^{(i)}} \rightarrow \Omega(\mathcal{V}_\alpha)$ is a surjective $H_n(0)$ -module homomorphism. Therefore, we only need to check $\ker(\partial_1) \subseteq \text{rad}\left(\bigoplus_{i \in \mathcal{I}(\alpha)} \mathbf{P}_{\alpha^{(i)}}\right)$ to complete the proof of the assertion. Let

$$\mathbf{T} := \bigoplus_{i \in \mathcal{I}(\alpha)} \mathbb{C}[\tau_{(i)}, \hat{\tau}_{(i)}] \quad \text{and} \quad \mathbf{B} := \bigoplus_{i \in \mathcal{I}(\alpha)} \mathbb{C}[\tau_{(i)}, \hat{\tau}_{(i)}]^c.$$

In the proof of Lemma 6.4, we see that $[\tau_{(i)}, \hat{\tau}_{(i)}]^c \subseteq \text{rad} \mathbf{P}_{\alpha^{(i)}}$ for $i \in \mathcal{I}(\alpha)$ and thus $\mathbf{B} \subseteq \text{rad}\left(\bigoplus_{i \in \mathcal{I}(\alpha)} \mathbf{P}_{\alpha^{(i)}}\right)$.

In the following, we will prove $\ker(\partial_1) \subseteq \mathbf{B}$, which is obviously a stronger inclusion than necessary. We begin by collecting the following properties, which were shown in the proof of Lemma 6.4: For all $i \in \mathcal{I}(\alpha)$, $1 \leq j < i$ and $\tau \in [\tau_{(i)}, \hat{\tau}_{(i)}]$,

$$\begin{aligned} \ker(\partial_1^{(i)}) &\subseteq \mathbb{C}[\tau_{(i)}, \hat{\tau}_{(i)}]^c, \\ \partial_1^{(i)}(\tau)_i^1 &= m_{i-1} + 2 \quad \text{and} \\ \partial_1^{(i)}(\tau)_j^1 &= m_{j-1} + 1. \end{aligned}$$

Therefore, for any $i, j \in \mathcal{I}(\alpha)$ with $j < i$, if $\tau \in [\tau_{(i)}, \hat{\tau}_{(i)}] \subseteq \mathbf{P}_{\alpha^{(i)}}$ and $\tau' \in [\tau_{(j)}, \hat{\tau}_{(j)}] \subseteq \mathbf{P}_{\alpha^{(j)}}$, then $\partial_1(\tau)_j^1 = \partial_1^{(i)}(\tau)_j^1 = m_{j-1} + 1$ and $\partial_1(\tau')_j^1 = \partial_1^{(j)}(\tau')_j^1 = m_{j-1} + 2$: that is, $\partial_1(\tau) \neq \partial_1(\tau')$. This implies that the set $\{\partial_1(\tau) \mid \tau \in [\tau_{(i)}, \hat{\tau}_{(i)}] \text{ for } i \in \mathcal{I}(\alpha)\}$ is linearly independent, hence every $\mathbf{x} \in \ker(\partial_1) \setminus \{0\}$ is decomposed as $\mathbf{x} = \mathbf{x}^{(1)} + \mathbf{x}^{(2)}$ for some $\mathbf{x}^{(1)} \in \mathbf{T}$ and $\mathbf{x}^{(2)} \in \mathbf{B} \setminus \{0\}$.

We claim that $\mathbf{x}^{(1)} = 0$. Suppose on the contrary that $\mathbf{x}^{(1)} \neq 0$. Let

$$\partial_1(\mathbf{x}^{(1)}) = \sum_{T \in \text{SRT}(\alpha) \cap \Omega(\mathcal{V}_\alpha)} c_T T \quad \text{and} \quad \partial_1(\mathbf{x}^{(2)}) = \sum_{T \in \text{SRT}(\alpha) \cap \Omega(\mathcal{V}_\alpha)} d_T T.$$

Since $\partial_1(\mathbf{x}^{(1)}) \neq 0$, there exists $T \in \text{SRT}(\alpha) \cap \Omega(\mathcal{V}_\alpha)$ such that $c_T \neq 0$. In addition, since $\text{SRT}(\alpha) \cap \Omega(\mathcal{V}_\alpha)$ is linearly independent and $\partial_1(\mathbf{x}) = 0$, we have $c_T = -d_T$. Therefore, there exist $i, j \in \mathcal{I}(\alpha)$, $\tau_{\mathbf{T}} \in [\tau_{(i)}, \hat{\tau}_{(i)}]$ and $\tau_{\mathbf{B}} \in [\tau_{(j)}, \hat{\tau}_{(j)}]^c$ such that $\partial_1(\tau_{\mathbf{T}}) = T = \partial_1(\tau_{\mathbf{B}})$. Since $\{\partial_1(\tau) \mid \tau \in \text{SRT}(\alpha^{(i)})\} \setminus \{0\}$ is linearly independent, we have $i \neq j$. Note that $\partial_1(\tau_{\mathbf{B}}) = \partial_1^{(j)}(\tau_{\mathbf{B}}) \in H_n(0) \cdot T_\alpha^{(j)}$. By Lemma 6.2, we have $T_j^1 > T_{j+1}^1$. On the other hand, since $T = \partial_1^{(i)}(\tau_{\mathbf{T}})$ and $\tau_{\mathbf{T}} \in [\tau_{(i)}, \hat{\tau}_{(i)}]$, T is equal to $T_\alpha^{(i)}$ except for the $(i + 1)$ st and $(i + 2)$ nd columns. Note that the $(i + 1)$ st and $(i + 2)$ nd columns of them are filled with $\{(\tau_{\mathbf{T}})_i^1\} \cup [m_i + 2, m_{i+2}]$ and $T_{i+1}^1 = \partial_1^{(i)}(\tau_{\mathbf{T}})_{i+1}^1 = m_{i-1} + 1$. This shows that $T_j^1 < T_{j+1}^1$, which is absurd. Hence $\mathbf{x}^{(1)} = 0$, and it follows that $\ker(\partial_1) \subseteq \mathbf{B}$, as required.

(b) For all $\beta \models n$, it is known that

$$\text{Ext}_{H_n(0)}^1(\mathcal{V}_\alpha, \mathbf{F}_\beta) = \text{Hom}_{H_n(0)}(P_1, \mathbf{F}_\beta)$$

with $P_1 := \bigoplus_{i \in \mathcal{I}(\alpha)} \mathbf{P}_{\alpha^{(i)}}$ (for instance, see [3, Corollary 2.5.4]). In the case with projective indecomposable modules, one has that $\dim \text{Hom}_{H_n(0)}(\mathbf{P}_\gamma, \mathbf{F}_{\gamma'}) = \delta_{\gamma, \gamma'}$ for all $\gamma, \gamma' \models n$ (see [3, Lemma 1.7.5]). This tells us that $\dim \text{Ext}_{H_n(0)}^1(\mathcal{V}_\alpha, \mathbf{F}_\beta)$ counts the multiplicity of \mathbf{P}_β in the decomposition of P_1 into indecomposables. The indecomposables that occur in the decomposition are precisely \mathbf{P}_β with $\beta \in \mathcal{J}(\alpha)$. We claim that all of them are multiplicity-free. For $i \in \mathcal{I}(\alpha)$, note that $[\alpha^{(i)}] = \{\beta^{(1)}, \beta^{(2)}\}$ with $\beta^{(1)}, \beta^{(2)}$ in equation (6.3). Obviously $\beta^{(1)}$ and $\beta^{(2)}$ are distinct. Furthermore, for $i < j$, $[\alpha^{(i)}]$ and $[\alpha^{(j)}]$ are disjoint since the i th entry of the compositions in the former is $\alpha_i + 1$, whereas that of the compositions in the latter is α_i . Hence the claim is verified, which completes the proof. \square

6.2. Proof of Theorem 4.1

We begin by introducing the necessary terminologies, notations and lemmas. First, we recall the notation related to parabolic subgroups of Σ_n . For each subset I of $[n - 1]$, we write $(\Sigma_n)_I$ for the parabolic subgroup of Σ_n generated by simple transpositions s_i with $i \in I$ and $w_0(I)$ for the longest element of $(\Sigma_n)_I$. When I is a subinterval $[k_1, k_2]$ of $[n - 1]$ and $c \in I$, we write $(\Sigma_n)_I^{(c)}$ for

$$\left\{ \sigma \in (\Sigma_n)_I \mid \begin{array}{l} \sigma(k_1) < \sigma(k_1 + 1) < \dots < \sigma(c) \text{ and} \\ \sigma(c + 1) < \sigma(c + 2) < \dots < \sigma(k_2 + 1) \end{array} \right\}$$

and $w_0(I; c)$ for the longest element of $(\Sigma_n)_I^{(c)}$ (see [8, Chapter 2]).

Next, we introduce the sink tableau of \mathbf{P}_α . Given a generalised composition α of n , \mathbf{P}_α contains a unique tableau T such that $\pi_i \cdot T = 0$ or T for all $i \in [n - 1]$. We call it the *sink tableau* of \mathbf{P}_α , denoted by T_α^{\leftarrow} . Explicitly, T_α^{\leftarrow} is obtained by filling in $\text{rd}(\alpha)$ with entries $1, 2, \dots, n$ from left to right and from top to bottom. Let us define a bijection

$$\chi_\alpha : \text{SRT}(\alpha) \rightarrow \bigcup_{\beta \in [\alpha]} \text{SRT}(\beta), \quad T \mapsto T',$$

where T' is uniquely determined by the condition $\mathbf{w}(T) = \mathbf{w}(T')$. With this bijection, we define

$$T_{\beta; \alpha}^{\leftarrow} := \chi_\alpha^{-1}(T_\beta^{\leftarrow}) \quad \text{for every } \beta \in [\alpha].$$

For $\beta \in [\alpha]$, we let

$$J_{\beta; \alpha} := \{i \in [n - 1] \mid \pi_i \cdot T_\beta^{\leftarrow} = 0, \text{ but } \pi_i \cdot T_{\beta; \alpha}^{\leftarrow} \neq 0\}.$$

For each $1 \leq i \leq n - 1$, let $\bar{\pi}_i := \pi_i - 1$. Pick up any reduced expression $s_{i_1} \cdots s_{i_p}$ for $\sigma \in \Sigma_n$. Let $\bar{\pi}_\sigma$ be the element of $H_n(0)$ defined by $\bar{\pi}_\sigma := \bar{\pi}_{i_1} \cdots \bar{\pi}_{i_p}$. It is well known that the element $\bar{\pi}_\sigma$ is independent of the choice of reduced expressions.

Lemma 6.5 [21, Lemma 3 (1)]. For any $\sigma, \rho \in \Sigma_n$, $\pi_\sigma \bar{\pi}_\rho$ is nonzero if and only if $\ell(\sigma\rho) = \ell(\sigma) + \ell(\rho)$.

The following lemma gives an explicit description for $\text{soc}(\mathbf{P}_\alpha)$.

Lemma 6.6. For $\beta \in [\underline{\alpha}]$, $\mathbb{C}T_\beta^\leftarrow$ is isomorphic to $\mathbb{C}(\bar{\pi}_{w_0(J_{\beta;\underline{\alpha}})} \cdot T_{\beta;\underline{\alpha}}^\leftarrow)$ as an $H_n(0)$ -module.

Proof. First, we claim that $\bar{\pi}_{w_0(J_{\beta;\underline{\alpha}})} \cdot T_{\beta;\underline{\alpha}}^\leftarrow$ is stabilised under the action of π_i for all $i \in \text{Des}(T_\beta^\leftarrow)^c$. Note that $\bar{\pi}_{w_0(J_{\beta;\underline{\alpha}})} \cdot T_{\beta;\underline{\alpha}}^\leftarrow$ is of the form

$$\sum_{T \in [T_{\beta;\underline{\alpha}}^\leftarrow, T_{\underline{\alpha}}^\leftarrow]} c_T T \quad \text{for some } c_T \in \mathbb{Z}. \tag{6.4}$$

But from the definitions of $T_{\beta;\underline{\alpha}}^\leftarrow$ and $T_{\underline{\alpha}}^\leftarrow$, it follows that $\pi_i \cdot T = T$ for $i \in \text{Des}(T_\beta^\leftarrow)^c$. Thus our claim is verified.

Next, we claim that $\pi_i \cdot (\bar{\pi}_{w_0(J_{\beta;\underline{\alpha}})} \cdot T_{\beta;\underline{\alpha}}^\leftarrow) = 0$ for all $i \in \text{Des}(T_\beta^\leftarrow)$. Take any $i \in \text{Des}(T_\beta^\leftarrow)$. Note that $T(S_{k_0}) = \{1, 2, \dots, \ell(\alpha)\}$ for any $T \in [T_{\beta;\underline{\alpha}}^\leftarrow, T_{\underline{\alpha}}^\leftarrow]$. Therefore, if $1 \leq i < \ell(\alpha)$, then $\pi_i \bar{\pi}_{w_0(J_{\beta;\underline{\alpha}})} \cdot T_{\beta;\underline{\alpha}}^\leftarrow = 0$ by equation (6.4). In the case where $i \geq \ell(\alpha)$, $i \in J_{\beta;\underline{\alpha}}$ and thus $\pi_i \bar{\pi}_{w_0(J_{\beta;\underline{\alpha}})} = 0$ by Lemma 6.5. \square

Example 6.7. Given $\alpha = (2^3)$, let $\beta = (1^2, 2, 1^2)$ and $\gamma = (2^2, 1^2)$ be compositions in $[\underline{\alpha}] = [(1) \oplus (1) \oplus (2, 1^2)]$. Note that

$$T_\beta^\leftarrow = \begin{array}{cccc} & & \boxed{1} & \boxed{2} & \boxed{3} \\ & & \boxed{4} & \boxed{5} & \boxed{6} \\ & & & & \end{array} \quad T_{\beta;\underline{\alpha}}^\leftarrow = \begin{array}{cccc} & & \boxed{1} & \boxed{2} & \boxed{3} \\ & & \boxed{5} & & \\ & & \boxed{4} & & \end{array} \quad \text{and} \quad T_\gamma^\leftarrow = \begin{array}{cccc} & & \boxed{1} & \boxed{2} & \boxed{3} \\ & & \boxed{4} & \boxed{5} & \\ & & \boxed{6} & & \end{array} \quad T_{\gamma;\underline{\alpha}}^\leftarrow = \begin{array}{cccc} & & \boxed{1} & \boxed{2} & \boxed{3} \\ & & \boxed{5} & & \\ & & \boxed{6} & \boxed{4} & \end{array}.$$

Since $J_{\beta;\underline{\alpha}} = \{4, 5\}$ and $J_{\gamma;\underline{\alpha}} = \{4\}$, it follows that $w_0(J_{\beta;\underline{\alpha}}) = s_4 s_5 s_4$ and $w_0(J_{\gamma;\underline{\alpha}}) = s_4$. Thus we have

$$\mathbb{C}T_\beta^\leftarrow \cong \mathbb{C} \left(\begin{array}{cccc} & & \boxed{1} & \boxed{2} & \boxed{3} \\ & & \boxed{4} & \boxed{5} & \boxed{6} \\ & & & & \end{array} - \begin{array}{cccc} & & \boxed{1} & \boxed{2} & \boxed{3} \\ & & \boxed{4} & \boxed{6} & \\ & & \boxed{5} & \boxed{4} & \end{array} - \begin{array}{cccc} & & \boxed{1} & \boxed{2} & \boxed{3} \\ & & \boxed{5} & \boxed{6} & \\ & & \boxed{6} & \boxed{4} & \end{array} + \begin{array}{cccc} & & \boxed{1} & \boxed{2} & \boxed{3} \\ & & \boxed{5} & \boxed{6} & \\ & & \boxed{6} & \boxed{4} & \end{array} + \begin{array}{cccc} & & \boxed{1} & \boxed{2} & \boxed{3} \\ & & \boxed{6} & \boxed{4} & \\ & & \boxed{6} & \boxed{5} & \end{array} - \begin{array}{cccc} & & \boxed{1} & \boxed{2} & \boxed{3} \\ & & \boxed{6} & \boxed{5} & \boxed{4} & \end{array} \right)$$

$$\mathbb{C}T_\gamma^\leftarrow \cong \mathbb{C} \left(\begin{array}{cccc} & & \boxed{1} & \boxed{2} & \boxed{3} \\ & & \boxed{6} & \boxed{4} & \\ & & \boxed{6} & \boxed{5} & \end{array} - \begin{array}{cccc} & & \boxed{1} & \boxed{2} & \boxed{3} \\ & & \boxed{6} & \boxed{5} & \boxed{4} & \end{array} \right).$$

Proof of Theorem 4.1. We first claim that $\epsilon : \mathcal{V}_\alpha \rightarrow \mathbf{P}_\alpha$ is an $H_n(0)$ -module homomorphism: that is,

$$\epsilon(\pi_i \cdot \mathcal{T}) = \pi_i \cdot \epsilon(\mathcal{T}) \quad \text{for } i = 1, 2, \dots, n-1 \text{ and } \mathcal{T} \in \text{SIT}(\alpha).$$

Let us fix $1 \leq i \leq n-1$ and $\mathcal{T} \in \text{SIT}(\alpha)$. Let $0 \leq x, y \leq m$ be integers satisfying that $i \in \mathcal{T}(S_{k_x})$ and $i+1 \in \mathcal{T}(S_{k_y})$.

Case 1: $\pi_i \cdot \mathcal{T} = \mathcal{T}$. First we handle the case where $x = 0$. Then i will be placed in the top row in $T^\mathcal{T}$. In view of the given condition $\pi_i \cdot \mathcal{T} = \mathcal{T}$, one sees that $x \neq y$. This implies that $i+1$ is strictly below i in $T^\mathcal{T}$. Next we handle the case where $x > 0$. The condition $\pi_i \cdot \mathcal{T} = \mathcal{T}$ says that $0 < x \leq y$; thus $i+1$ is strictly below i in $T^\mathcal{T}$. In either case, it is immediate from equation (2.1) that $\pi_i \cdot T^\mathcal{T} = T^\mathcal{T}$.

Case 2: $\pi_i \cdot \mathcal{T} = 0$. From equation (2.2), it follows that i and $i+1$ are in the first column in \mathcal{T} : that is, $x = y = 0$. Hence, in $T^\mathcal{T}$, both of them will appear in $T^\mathcal{T}(S_{k_0})$. As in *Case 1*, one can derive from equation (2.1) that $\pi_i \cdot T^\mathcal{T} = 0$.

Case 3: $\pi_i \cdot \mathcal{T} = s_i \cdot \mathcal{T}$. We claim that $\epsilon(s_i \cdot \mathcal{T}) = s_i \cdot T^\mathcal{T}$. Observe that i appears strictly above $i+1$ in \mathcal{T} . If $i+1 \in \mathcal{T}(S_{k_0})$, then we see that $i \notin \mathcal{T}(S_{k_0})$, which means i appears strictly left of $i+1$ in $T^\mathcal{T}$. Otherwise, we also see that $i \notin \mathcal{T}(S_{k_0})$. More precisely, if $i+1 \notin \mathcal{T}(S_{k_0})$ and $i \in \mathcal{T}(S_{k_0})$, then \mathcal{T} is not an SIT since the entries in the row containing $i+1$ of \mathcal{T} do not increase from left to right.

It follows from the construction of $T^{\mathcal{T}}$ that i is strictly below $i + 1$ in $T^{\mathcal{T}}$. In either case, it holds that $T^{s_i \cdot \mathcal{T}} = s_i \cdot T^{\mathcal{T}}$. Thus we conclude that

$$\pi_i \cdot \epsilon(\mathcal{T}) = \pi_i \cdot T^{\mathcal{T}} = T^{s_i \cdot \mathcal{T}} = \epsilon(s_i \cdot \mathcal{T}) = \epsilon(\pi_i \cdot \mathcal{T}).$$

We next claim that $\mathbf{P}_{\underline{\alpha}}$ is an essential extension of $\epsilon(\mathcal{V}_{\alpha})$. To do this, we see that $\text{soc}(\mathbf{P}_{\underline{\alpha}}) \subset \epsilon(\mathcal{V}_{\alpha})$. Note that

$$\text{soc}(\mathbf{P}_{\underline{\alpha}}) \cong \text{soc}\left(\bigoplus_{\beta \in [\underline{\alpha}]} \mathbf{P}_{\beta}\right) \cong \bigoplus_{\beta \in [\underline{\alpha}]} \mathbb{C}T_{\beta}^{\leftarrow}.$$

In view of Lemma 6.6, one sees that

$$\text{soc}(\mathbf{P}_{\underline{\alpha}}) = \bigoplus_{\beta \in [\underline{\alpha}]} \mathbb{C}\left(\bar{\pi}_{w_0(\mathcal{J}_{\beta;\underline{\alpha}})} \cdot T_{\beta;\underline{\alpha}}^{\leftarrow}\right). \tag{6.5}$$

Choose any $\beta \in [\underline{\alpha}]$. Then

$$\bar{\pi}_{w_0(\mathcal{J}_{\beta;\underline{\alpha}})} \cdot T_{\beta;\underline{\alpha}}^{\leftarrow} = \sum_{\sigma \in (\Sigma_n)_{\mathcal{J}_{\beta;\underline{\alpha}}}} (-1)^{\ell(w_0(\mathcal{J}_{\beta;\underline{\alpha}})) - \ell(\sigma)} \pi_{\sigma} \cdot T_{\beta;\underline{\alpha}}^{\leftarrow}.$$

For $\sigma \in (\Sigma_n)_{\mathcal{J}_{\beta;\underline{\alpha}}}$, since $(\pi_{\sigma} \cdot T_{\beta;\underline{\alpha}}^{\leftarrow})(S_{k_0}) = \{1, 2, \dots, \ell(\alpha)\}$, we have

$$(\pi_{\sigma} \cdot T_{\beta;\underline{\alpha}}^{\leftarrow})_{m+k_j-1}^1 < \begin{cases} (\pi_{\sigma} \cdot T_{\beta;\underline{\alpha}}^{\leftarrow})_j^1 & \text{if } 1 \leq j < m, \\ (\pi_{\sigma} \cdot T_{\beta;\underline{\alpha}}^{\leftarrow})_j^2 & \text{if } j = m. \end{cases}$$

It means $\pi_{\sigma} \cdot T_{\beta;\underline{\alpha}}^{\leftarrow} \in \epsilon(\mathcal{V}_{\alpha})$ for all $\sigma \in (\Sigma_n)_{\mathcal{J}_{\beta;\underline{\alpha}}}$. Combining this with equation (6.5) yields that $\text{soc}(\mathbf{P}_{\underline{\alpha}}) \subset \epsilon(\mathcal{V}_{\alpha})$. □

6.3. Proof of Theorem 4.3

Throughout this section, let us fix an integer $1 \leq j \leq m$ unless otherwise stated.

Let $T \in \text{SRT}(\underline{\alpha})$. In the same notation as in Section 4, we claim that

$$\tau_{T;j} \neq 0 \quad \text{if and only if} \quad T_j^{1+\delta_{j,m}} < T_{m+k_j-1}^1. \tag{6.6}$$

This is because if $T_j^{1+\delta_{j,m}} < T_{m+k_j-1}^1$, then $\text{end}(\mathbf{w}_{T;j}) < T_{m+k_j-1}^1$ and therefore $\tau_{T;j} \neq 0$. Otherwise, $\tau_{T;j}$ should be zero since $\text{end}(\mathbf{w}_{T;j}) > T_{m+k_j-1}^1$.

Let $\beta \in [\underline{\alpha}_{(j)}]$. Recall that $T_{\beta;\underline{\alpha}_{(j)}}^{\leftarrow} = \chi_{\underline{\alpha}_{(j)}}^{-1}(T_{\beta}^{\leftarrow})$ and

$$\mathcal{J}_{\beta;\underline{\alpha}_{(j)}} = \{i \in [n-1] \mid \pi_i \cdot T_{\beta}^{\leftarrow} = 0, \text{ but } \pi_i \cdot T_{\beta;\underline{\alpha}_{(j)}}^{\leftarrow} \neq 0\}.$$

Note that if $\min(\mathcal{J}_{\beta;\underline{\alpha}_{(j)}}) \leq \ell(\alpha)$, then

$$\min(\mathcal{J}_{\beta;\underline{\alpha}_{(j)}}) = |S'_{k_0}| \quad \text{and} \quad \min\left(\mathcal{J}_{\beta;\underline{\alpha}_{(j)}} \setminus \{|S'_{k_0}|\}\right) > \ell(\alpha) + 1. \tag{6.7}$$

Set

$$\widehat{\mathcal{J}}_{\beta;\underline{\alpha}_{(j)}} := \begin{cases} \mathcal{J}_{\beta;\underline{\alpha}_{(j)}} \setminus \{|S'_{k_0}|\} & \text{if } 1 \leq \min(\mathcal{J}_{\beta;\underline{\alpha}_{(j)}}) \leq \ell(\alpha), \\ \mathcal{J}_{\beta;\underline{\alpha}_{(j)}} & \text{otherwise,} \end{cases}$$

and

$$w_0(\beta; j) := \begin{cases} w_0([\ell(\alpha)]; |S'_{k_0}|) \cdot w_0(\widehat{J}_{\beta; \underline{\alpha}_{(j)}}) & \text{if } 1 \leq \min(J_{\beta; \underline{\alpha}_{(j)}}) \leq \ell(\alpha), \\ w_0(J_{\beta; \underline{\alpha}_{(j)}}) & \text{otherwise.} \end{cases}$$

In view of equation (6.7), we know that every element of $(\Sigma_n)_{[\ell(\alpha)]}^{(|S'_{k_0}|)}$ commutes with that of $(\Sigma_n)_{\widehat{J}_{\beta; \underline{\alpha}_{(j)}}}$.

The following lemma is necessary to show that $\text{soc}(\bigoplus_{1 \leq j \leq m} \mathbf{P}_{\underline{\alpha}_{(j)}}) \subseteq \text{Im}(\overline{\partial^1})$.

Lemma 6.8. For $1 \leq j \leq m$ and $\beta \in [\underline{\alpha}_{(j)}]$, $\mathbb{C}T_{\beta}^{\leftarrow} \cong \mathbb{C}(\overline{\pi}_{w_0(\beta; j)} \cdot T_{\beta; \underline{\alpha}_{(j)}}^{\leftarrow})$ as $H_n(0)$ -modules.

Proof. Let $1 \leq j \leq m$ and $\beta \in [\underline{\alpha}_{(j)}]$. If $\min(J_{\beta; \underline{\alpha}_{(j)}}) > \ell(\alpha)$, then one can prove the assertion in the same way as in Lemma 6.6. We now assume that $\min(J_{\beta; \underline{\alpha}_{(j)}}) \leq \ell(\alpha)$. We first show that

$$\pi_i \cdot (\overline{\pi}_{w_0(\beta; j)} \cdot T_{\beta; \underline{\alpha}_{(j)}}^{\leftarrow}) = \overline{\pi}_{w_0(\beta; j)} \cdot T_{\beta; \underline{\alpha}_{(j)}}^{\leftarrow}$$

for $i \notin \text{Des}(T_{\beta}^{\leftarrow})$. Since

$$\overline{\pi}_{w_0(\beta; j)} \cdot T_{\beta; \underline{\alpha}_{(j)}}^{\leftarrow} = \sum_{T \in [T_{\beta; \underline{\alpha}_{(j)}}^{\leftarrow}, T_{\underline{\alpha}_{(j)}}^{\leftarrow}]} c_T T \quad \text{for some } c_T \in \mathbb{Z},$$

it suffices to show that $\pi_i \cdot T = T$ for $i \notin \text{Des}(T_{\beta}^{\leftarrow})$ and $T \in [T_{\beta; \underline{\alpha}_{(j)}}^{\leftarrow}, T_{\underline{\alpha}_{(j)}}^{\leftarrow}]$. Since $\{1, 2, \dots, \ell(\alpha)\} \subseteq \text{Des}(T_{\beta}^{\leftarrow})$ by definition, we only consider that $i \geq \ell(\alpha) + 1$. If $i = \ell(\alpha) + 1$, then the assertion follows from the fact that $T(S'_{k_0}) \cup T(S'_{k-1}) = \{1, 2, \dots, \ell(\alpha) + 1\}$. Otherwise, from the definitions of $T_{\beta; \underline{\alpha}_{(j)}}^{\leftarrow}$ and $T_{\underline{\alpha}_{(j)}}^{\leftarrow}$, it follows that $\pi_i \cdot T = T$ for $i \notin \text{Des}(T_{\beta}^{\leftarrow})$. Thus our claim is verified.

We next show that $\pi_i \cdot (\overline{\pi}_{w_0(\beta; j)} \cdot T_{\beta; \underline{\alpha}_{(j)}}^{\leftarrow}) = 0$ for $i \in \text{Des}(T_{\beta}^{\leftarrow})$. Take any $i \in \text{Des}(T_{\beta}^{\leftarrow})$. If $i > \ell(\alpha) + 1$, then $i \in \widehat{J}_{\beta; \underline{\alpha}_{(j)}}$. Therefore, by Lemma 6.5, we have $\pi_i \overline{\pi}_{w_0(\beta; j)} = 0$, which implies $\pi_i \overline{\pi}_{w_0(\beta; j)} \cdot T_{\beta; \underline{\alpha}_{(j)}}^{\leftarrow} = 0$. Suppose that $i \leq \ell(\alpha) + 1$. Since $\ell(\alpha) + 1 \notin \text{Des}(T_{\beta}^{\leftarrow})$, we have that $1 \leq i \leq \ell(\alpha)$. If $i \in \text{Des}_L(w_0(\beta; j))$, then $\pi_i \overline{\pi}_{w_0(\beta; j)} = 0$. Thus, $\pi_i \overline{\pi}_{w_0(\beta; j)} \cdot T_{\beta; \underline{\alpha}_{(j)}}^{\leftarrow} = 0$. Otherwise, we have $s_i w_0([\ell(\alpha)]; |S'_{k_0}|) = \sigma s_{i'}$ for some $\sigma \in (\Sigma_n)_{[\ell(\alpha)]}^{(|S'_{k_0}|)}$ and $1 \leq i' \leq \ell(\alpha)$ with $i' \neq |S'_{k_0}|$ since $w_0([\ell(\alpha)]; |S'_{k_0}|)$ is the unique longest element in $(\Sigma_n)_{[\ell(\alpha)]}^{(|S'_{k_0}|)}$. Combining this with [21, Lemma 1], we have that $\pi_i \overline{\pi}_{w_0(\beta; j)} = \mathbf{h} \pi_{i'}$ for some $\mathbf{h} \in H_n(0)$ and $1 \leq i' \leq \ell(\alpha)$ with $i' \neq |S'_{k_0}|$. Since $\pi_{i'} \cdot T_{\beta; \underline{\alpha}_{(j)}}^{\leftarrow} = 0$ for all $1 \leq i' \leq \ell(\alpha)$ with $i' \neq |S'_{k_0}|$, it follows that

$$\pi_i \cdot (\overline{\pi}_{w_0(\beta; j)} \cdot T_{\beta; \underline{\alpha}_{(j)}}^{\leftarrow}) = \mathbf{h} \pi_{i'} \cdot T_{\beta; \underline{\alpha}_{(j)}}^{\leftarrow} = 0. \quad \square$$

Example 6.9. Let $\alpha = (2, 1, 2, 3) \models 8$. Note that $\mathcal{K}(\alpha) = \{0, 1, 3, 4\}$ and $\ell(\alpha) = 4$. Then $\underline{\alpha}_{(2)} = (1) \oplus (3, 1^2) \oplus (1^2)$. Let $\beta = (1, 3, 1^4)$ and $\gamma = (1, 3, 1, 2, 1)$ in $[\underline{\alpha}_{(2)}]$. Note that

$$T_{\beta}^{\leftarrow} = \begin{array}{cccccc} & & & & 4 & 5 \\ & & & & \boxed{1} & \boxed{2} & \boxed{3} & \boxed{4} & \boxed{5} \\ & & & & \boxed{6} & & & & \\ \boxed{7} & \boxed{8} & & & & & & & \end{array} \quad T_{\beta; \underline{\alpha}_{(2)}}^{\leftarrow} = \begin{array}{cccc} & & & 4 & 5 \\ & & & \boxed{1} & \boxed{2} & \boxed{3} \\ & & & \boxed{6} & & \\ \boxed{7} & \boxed{8} & & & & \end{array} \quad T_{\gamma}^{\leftarrow} = \begin{array}{cccc} & & & 1 & 2 \\ & & & \boxed{3} & \boxed{4} & \boxed{5} \\ & & & \boxed{6} & & \\ \boxed{7} & \boxed{8} & & & & \end{array} \quad T_{\gamma; \underline{\alpha}_{(2)}}^{\leftarrow} = \begin{array}{cccc} & & & 1 & 2 \\ & & & \boxed{3} & \boxed{4} & \boxed{5} \\ & & & \boxed{6} & & \\ \boxed{7} & \boxed{8} & & & & \end{array}$$

Here the entries i in red in each SRT T are being used to indicate that $\pi_i \cdot T = 0$. Since $\min(J_{\beta; \underline{\alpha}_{(2)}}) = 3 \leq \ell(\alpha)$ and $\min(J_{\gamma; \underline{\alpha}_{(2)}}) = 7 > \ell(\alpha)$,

$$w_0(\beta; 2) = s_2 s_3 s_4 s_1 s_2 s_3 \cdot s_7 \quad \text{and} \quad w_0(\gamma; 2) = s_7.$$

Therefore, by Lemma 6.8, we have

$$\mathbb{C}T_{\beta}^{\leftarrow} \cong \mathbb{C}(\bar{\pi}_2\bar{\pi}_3\bar{\pi}_4\bar{\pi}_1\bar{\pi}_2\bar{\pi}_3\bar{\pi}_7 \cdot T_{\beta;\underline{\alpha}(2)}^{\leftarrow}) \quad \text{and} \quad \mathbb{C}T_{\gamma}^{\leftarrow} \cong \mathbb{C}(\bar{\pi}_7 \cdot T_{\gamma;\underline{\alpha}(2)}^{\leftarrow}).$$

From now on, suppose that $n \geq 3$. Fix $l \in [2, n - 1]$ and $c \in [2, l]$. For $\omega \in (\Sigma_n)_{[l]}^{(c)}$, let $\Delta(\omega)$ be the permutation in $(\Sigma_n)_{[l]}^{(c)}$ such that $\Delta(\omega)(i) = \omega(1) + i - 1$ for $1 \leq i \leq c$. Then we consider the map

$$\phi : (\Sigma_n)_{[l]}^{(c)} \rightarrow (\Sigma_n)_{[l]}, \quad \omega \mapsto \omega\Delta(\omega)^{-1}.$$

It can be easily seen that

- $\phi(\omega)(i) = i$ for $1 \leq i \leq \omega(1)$,
 - $\phi(\omega)(\omega(1) + 1) < \phi(\omega)(\omega(1) + 2) < \dots < \phi(\omega)(\omega(1) + c - 1)$,
 - $\phi(\omega)(\omega(1) + c) < \phi(\omega)(\omega(1) + c + 1) < \dots < \phi(\omega)(l + 1)$
- (6.8)

and particularly ϕ is an injective map. Note that $\omega(1)$ can have values belonging to $[l - c + 2]$. For $1 \leq u \leq l - c + 2$, equation (6.8) implies that

$$\phi\left(\{\omega \in (\Sigma_n)_{[l]}^{(c)} : \omega(1) = u\}\right) = (\Sigma_n)_{[u+1, l]}^{(c+u-1)}.$$

Here $(\Sigma_n)_{[u+1, l]}^{(l+1)}$ is set to be $\{id\}$. Hence, letting Δ_u be the permutation in $(\Sigma_n)_{[l]}^{(c)}$ such that $\Delta_u(i) = u+i-1$ for $1 \leq i \leq c$, we have the following decomposition:

$$(\Sigma_n)_{[l]}^{(c)} = \bigsqcup_{1 \leq u \leq l-c+2} \left\{ \zeta \Delta_u \mid \zeta \in (\Sigma_n)_{[u+1, l]}^{(c+u-1)} \right\}. \tag{6.9}$$

In the following, for each $\omega \in (\Sigma_n)_{[l]}^{(c)}$, we will show that $\pi_{\omega} = \pi_{\phi(\omega)}\pi_{\Delta(\omega)}$. Note that

$$\ell(\Delta(\omega)) = c(\omega(1) - 1) \quad \text{and} \quad \ell(\omega) = \sum_{1 \leq i \leq c} (\omega(i) - i). \tag{6.10}$$

Since $\phi(\omega) \in (\Sigma_n)_{[\omega(1)+1, l]}^{(c+\omega(1)-1)}$,

$$\ell(\phi(\omega)) = \sum_{\omega(1)+1 \leq i \leq \omega(1)+c-1} (\phi(\omega)(i) - i) = \sum_{1 \leq i \leq c-1} (\phi(\omega)(\omega(1) + i) - \omega(1) - i).$$

From the construction of ϕ , one sees that $\phi(\omega)(\omega(1) + i) = \omega(i + 1)$, and thus

$$\ell(\phi(\omega)) = \sum_{1 \leq i \leq c-1} (\omega(i + 1) - \omega(1) - i).$$

Combining this equality with equation (6.10) yields that

$$\begin{aligned} \ell(\phi(\omega)) + \ell(\Delta(\omega)) &= \sum_{1 \leq i \leq c-1} (\omega(i + 1) - \omega(1) - i) + c(\omega(1) - 1) \\ &= \sum_{1 \leq i \leq c} (\omega(i) - i) = \ell(\omega). \end{aligned}$$

Since $\omega = \phi(\omega)\Delta(\omega)$, we have that $\Delta(\omega) \leq_L \omega$, and thus

$$\pi_{\omega} = \pi_{\phi(\omega)}\pi_{\Delta(\omega)}. \tag{6.11}$$

Let $1 \leq j \leq m$ and $\beta \in [\underline{\alpha}_{(j)}]$. For $\sigma \leq_L \mathbf{w}_0(\beta; j)$, we define $T_{j;\beta}(\sigma)$ to be the filling of $\text{rd}(\underline{\alpha})$ such that the column strip S_{k_r} ($1 \leq r \leq m$) is filled with the entries of

$$\begin{cases} (\pi_\sigma \cdot T_{\beta;\underline{\alpha}_{(j)}}^{\leftarrow})(S'_{k_j}) \cup \{\min((\pi_\sigma \cdot T_{\beta;\underline{\alpha}_{(j)}}^{\leftarrow})(S'_{k_0}))\} & \text{if } r = j, \\ (\pi_\sigma \cdot T_{\beta;\underline{\alpha}_{(j)}}^{\leftarrow})(S'_{k_r}) & \text{otherwise} \end{cases}$$

in such a way that the entries increase from top to bottom and the row strip S_{k_0} is filled with the entries of

$$((\pi_\sigma \cdot T_{\beta;\underline{\alpha}_{(j)}}^{\leftarrow})(S'_{k_{-1}}) \cup (\pi_\sigma \cdot T_{\beta;\underline{\alpha}_{(j)}}^{\leftarrow})(S'_{k_0})) \setminus \{\min((\pi_\sigma \cdot T_{\beta;\underline{\alpha}_{(j)}}^{\leftarrow})(S'_{k_0}))\}$$

in such a way that the entries increase from left to right.

Example 6.10. Let us revisit Example 6.9. Recall $\beta = (1, 3, 1^4)$ and $\underline{\alpha}_{(2)} = (1) \oplus (3, 1^2) \oplus (1^2)$. For $\sigma = s_{[1,3]}, s_4 s_{[1,3]}$ and $s_{[3,4]} s_{[1,3]}$, it holds that $\sigma \leq_L \mathbf{w}_0(\beta; 2)$ and

$$\pi_{[1,3]} \cdot T_{\beta;\underline{\alpha}_{(2)}}^{\leftarrow} = \begin{array}{cccc} & & & 1\ 5 \\ & & & \boxed{2\ 3\ 4} \\ & & & \boxed{6} \\ & & & \boxed{8} \\ & & & \boxed{7} \end{array}, \quad \pi_4 \pi_{[1,3]} \cdot T_{\beta;\underline{\alpha}_{(2)}}^{\leftarrow} = \begin{array}{cccc} & & & 1\ 4 \\ & & & \boxed{2\ 3\ 5} \\ & & & \boxed{6} \\ & & & \boxed{8} \\ & & & \boxed{7} \end{array}, \quad \pi_{[3,4]} \pi_{[1,3]} \cdot T_{\beta;\underline{\alpha}_{(2)}}^{\leftarrow} = \begin{array}{cccc} & & & 1\ 3 \\ & & & \boxed{2\ 4\ 5} \\ & & & \boxed{6} \\ & & & \boxed{8} \\ & & & \boxed{7} \end{array}.$$

Using these, we can check that

$$T_{2;(1,3,1^4)}(\sigma) = \begin{array}{cccc} & & & 1\ 3\ 4\ 5 \\ & & & \boxed{6} \\ & & & \boxed{8} \\ & & & \boxed{2} \\ & & & \boxed{7} \end{array}$$

for all $\sigma = s_{[1,3]}, s_4 s_{[1,3]}, s_3 s_4 s_{[1,3]}$.

If there is no confusion for j and β , then we simply write $T(\sigma)$ for $T_{j;\beta}(\sigma)$. For $\Theta(\mathcal{V}_\alpha)$ defined in equation (4.1), we have the following lemma.

Lemma 6.11. *Suppose we have a pair (j, β) with $1 \leq j \leq m$ and $\beta \in [\underline{\alpha}_{(j)}]$ satisfying that $\min(J_{\beta;\underline{\alpha}_{(j)}}) \leq \ell(\alpha)$. Then for every permutation $\sigma \in \Sigma_n$ with $\sigma \leq_L \mathbf{w}_0(\beta; j)$, it holds that $T(\sigma) \in \Theta(\mathcal{V}_\alpha)$.*

Proof. It is clear that $T(\sigma) \in \text{SRT}(\underline{\alpha})$. Thus, for the assertion, we have only to show that $T(\sigma)_j^{1+\delta_{j,m}} < T(\sigma)_{m+k_j-1}^1$. Note that

$$(\pi_\sigma \cdot T_{\beta;\underline{\alpha}_{(j)}}^{\leftarrow})(S'_{k_{-1}}) \cup (\pi_\sigma \cdot T_{\beta;\underline{\alpha}_{(j)}}^{\leftarrow})(S'_{k_0}) = \{1, 2, \dots, \ell(\alpha) + 1\},$$

which implies that

$$1 \leq \min((\pi_\sigma \cdot T_{\beta;\underline{\alpha}_{(j)}}^{\leftarrow})(S'_{k_0})) \leq |S'_{k_{-1}}| + 1.$$

Since $|S'_{k_{-1}}| = k_j - 1$, it follows that $\min((\pi_\sigma \cdot T_{\beta;\underline{\alpha}_{(j)}}^{\leftarrow})(S'_{k_0})) \leq k_j$. On the other hand, from the observation that $T(\sigma)_{m+k_j-1}^1$ is the k_j th smallest element in the set

$$\{1, 2, \dots, \ell(\alpha) + 1\} \setminus \{\min(\pi_\sigma \cdot T_{\beta;\underline{\alpha}_{(j)}}^{\leftarrow})(S'_{k_0})\},$$

we see that $k_j < T(\sigma)_{m+k_j-1}^1$. As a consequence, we derive the following inequality:

$$T(\sigma)_j^{1+\delta_{j,m}} = \min((\pi_\sigma \cdot T_{\beta;\underline{\alpha}_{(j)}}^{\leftarrow})(S'_{k_0})) \leq k_j < T(\sigma)_{m+k_j-1}^1. \quad \square$$

We are now ready to prove Theorem 4.3.

Proof of Theorem 4.3. (a) Given $1 \leq i \leq n - 1$ and $T \in \text{SRT}(\underline{\alpha})$, we have three cases.

Case 1: $\pi_i \cdot T = T$. We claim that $i \notin \text{Des}(\tau_{T;j;A})$ for all $1 \leq j \leq m$ and $A \in \mathcal{P}(\mathbf{A}_{T;j})$. Fix $j \in [m]$ and $A \in \mathcal{P}(\mathbf{A}_{T;j})$. Since $i \notin \text{Des}(T)$, i is weakly right of $i + 1$ in T . If neither i nor $i + 1$ appears in $\mathbf{w}_{T;j}$, then i and $i + 1$ still hold their positions in $\tau_{T;j;A}$, so $i \notin \text{Des}(\tau_{T;j;A})$. If i appears in $\mathbf{w}_{T;j}$ and $i + 1$ does not appear in $\mathbf{w}_{T;j}$, then $i + 1$ holds its position in $\tau_{T;j;A}$ but i is moved to the right in $\tau_{T;j;A}$, so $i \notin \text{Des}(\tau_{T;j;A})$. Suppose that i does not appear in $\mathbf{w}_{T;j}$ and $i + 1 = w_{u_k}$ for some $1 \leq k \leq l$, where $\mathbf{w}_{T;j} = w_{u_1} w_{u_2} \cdots w_{u_l}$. By the definition of $\mathbf{w}_{T;j}$, $w_{u_{k+1}} < i$ and appears strictly left of i if $k < l$, and $i \in T(\mathbf{S}_{k_0})$ if $k = l$. Thus, $i \notin \text{Des}(\tau_{T;j;A})$.

Case 2: $\pi_i \cdot T = 0$. We claim that $\pi_i \cdot \tau_{T;j} = 0$ for all $1 \leq j \leq m$. Fix $j \in [m]$. Since $i, i + 1 \in T(\mathbf{S}_0)$ by the shape of T , $\text{end}(\mathbf{w}_{T;j}) \neq i, i + 1$. So we have from the definition of $\mathbf{A}_{T;j}$ that either $i, i + 1 \notin \mathbf{A}_{T;j}$ or $i, i + 1 \in \mathbf{A}_{T;j}$. If $i, i + 1 \notin \mathbf{A}_{T;j}$, then $i, i + 1 \in \tau_{T;j;A}(\mathbf{S}'_{k-1})$ for all $A \in \mathcal{P}(\mathbf{A}_{T;j})$, so $\pi_i \cdot \tau_{T;j} = 0$. If $i, i + 1 \in \mathbf{A}_{T;j}$, then $\mathcal{P}(\mathbf{A}_{T;j}) = \mathcal{X} \cup \mathcal{Y} \cup \mathcal{Z}$, where

$$\begin{aligned} \mathcal{X} &:= \{A \in \mathcal{P}(\mathbf{A}_{T;j}) \mid i \in A, i + 1 \notin A\} \\ \mathcal{Y} &:= \{A \in \mathcal{P}(\mathbf{A}_{T;j}) \mid i \notin A, i + 1 \in A\} \\ \mathcal{Z} &:= \{A \in \mathcal{P}(\mathbf{A}_{T;j}) \mid i, i + 1 \in A\} \cup \{A \in \mathcal{P}(\mathbf{A}_{T;j}) \mid i, i + 1 \notin A\} \end{aligned}$$

Note that $\pi_i \cdot \tau_{T;j;A} = 0$ for any $A \in \mathcal{Z}$. Therefore, the claim can be shown by proving that

$$\pi_i \left(\sum_{A \in \mathcal{X}} \text{sgn}(A) \tau_{T;j;A} + \sum_{A \in \mathcal{Y}} \text{sgn}(A) \tau_{T;j;A} \right) = 0. \tag{6.12}$$

Let us consider the bijection $f : \mathcal{X} \rightarrow \mathcal{Y}$ by

$$A \mapsto (A \setminus \{i\}) \cup \{i + 1\}.$$

Since $\text{sgn}(A) + \text{sgn}(f(A)) = 0$ and $\tau_{T;j;f(A)} = s_i \cdot \tau_{T;j;A}$, we obtain equation (6.12).

Case 3: $\pi_i \cdot T = s_i \cdot T$. We claim that $\pi_i \cdot \tau_{T;j} = \tau_{(\pi_i \cdot T);j}$ for all $1 \leq j \leq m$. Fix $1 \leq j \leq m$ with $\tau_{T;j} \neq 0$. If $i + 1 \notin T(\mathbf{S}_{k_0})$, then $\text{end}(\mathbf{w}_{T;j}) = \text{end}(\mathbf{w}_{\pi_i \cdot T;j})$ and $\mathbf{A}_{T;j} = \mathbf{A}_{(\pi_i \cdot T);j}$, so $\mathcal{P}(\mathbf{A}_{T;j}) = \mathcal{P}(\mathbf{A}_{(\pi_i \cdot T);j})$. This implies that

$$\pi_i \cdot \tau_{T;j} = \pi_i \left(\sum_{A \in \mathcal{P}(\mathbf{A}_{T;j})} \text{sgn}(A) \tau_{T;j;A} \right) = \sum_{A \in \mathcal{P}(\mathbf{A}_{\pi_i \cdot T;j})} \text{sgn}(A) \tau_{\pi_i \cdot T;j;A} = \tau_{(\pi_i \cdot T);j}.$$

Let us assume that $i + 1 \in T(\mathbf{S}_{k_0})$. First, we consider the case where $\text{end}(\mathbf{w}_{T;j}) = i$. Combining the assumption $\tau_{T;j} \neq 0$ with equation (6.6) yields that $T^1_{m+k_j-1} > i$. In addition, for any $A \in \mathcal{P}(\mathbf{A}_{T;j})$ with $i + 1 \in A$, we have $\pi_i \cdot \tau_{T;j;A} = 0$. Therefore,

$$\pi_i \cdot \tau_{T;j} = \sum_{\substack{A \in \mathcal{P}(\mathbf{A}_{T;j}) \\ i+1 \notin A}} \text{sgn}(A) \pi_i \cdot \tau_{T;j;A}. \tag{6.13}$$

On the other hand, since $\text{end}(\mathbf{w}_{\pi_i \cdot T;j}) = i + 1$, we have

$$\mathcal{P}(\mathbf{A}_{\pi_i \cdot T;j}) = \{A \in \mathcal{P}(\mathbf{A}_{T;j}) \mid i + 1 \notin A\}.$$

This implies that

$$\tau_{\pi_i \cdot T;j} = \sum_{A \in \mathcal{P}(\mathbf{A}_{\pi_i \cdot T;j})} \text{sgn}(A) \tau_{\pi_i \cdot T;j;A} = \sum_{\substack{A \in \mathcal{P}(\mathbf{A}_{T;j}) \\ i+1 \notin A}} \text{sgn}(A) \tau_{\pi_i \cdot T;j;A}. \tag{6.14}$$

For any $A \in \mathcal{P}(\mathbf{A}_{T;j})$ with $i + 1 \notin A$, one can see that $\pi_i \cdot \tau_{T;j;A} = \tau_{\pi_i \cdot T;j;A}$. Combining this equality with the equalities given by equations (6.13) and (6.14), we have $\pi_i \cdot \tau_{T;j} = \tau_{\pi_i \cdot T;j}$.

Next, we consider the case where $\text{end}(\mathbf{w}_{T;j}) \neq i$. Then one sees that

$$\mathbf{A}_{(\pi_i \cdot T);j} = \begin{cases} \mathbf{A}_{T;j} & \text{if } \text{end}(\mathbf{w}_{T;j}) > i, \\ (\mathbf{A}_{T;j} \setminus \{i + 1\}) \cup \{i\} & \text{if } \text{end}(\mathbf{w}_{T;j}) < i. \end{cases}$$

In the former case, one can see that $\pi_i \cdot \tau_{T;j} = \tau_{(\pi_i \cdot T);j}$ by mimicking the proof of the case where $i + 1 \notin T(S_{k_0})$. For the latter case, set

$$f : \mathcal{P}(\mathbf{A}_{T;j}) \rightarrow \mathcal{P}(\mathbf{A}_{(\pi_i \cdot T);j}), \quad A \mapsto f(A) := \begin{cases} (A \setminus \{i + 1\}) \cup \{i\} & \text{if } i + 1 \in A, \\ A & \text{otherwise.} \end{cases}$$

It is clear that f is bijective. Moreover, since $\text{sgn}(A) = \text{sgn}(f(A))$ and $\pi_i \cdot \tau_{T;j;A} = \tau_{(\pi_i \cdot T);j;f(A)}$, it follows that

$$\pi_i \cdot \tau_{T;j} = \sum_{A \in \mathcal{P}(\mathbf{A}_{T;j})} \text{sgn}(A) \pi_i \cdot \tau_{T;j;A} = \sum_{f(A) \in \mathcal{P}(\mathbf{A}_{(\pi_i \cdot T);j})} \text{sgn}(f(A)) \tau_{(\pi_i \cdot T);j;f(A)} = \tau_{(\pi_i \cdot T);j}.$$

(b) Let us show $\ker(\partial^1) \supseteq \epsilon(\mathcal{V}_\alpha)$. Recall that

$$\epsilon(\mathcal{V}_\alpha) = \mathbb{C}\{T \in \text{SRT}(\underline{\alpha}) \mid T_j^{1+\delta_{j,m}} > T_{m+k_j-1}^1 \text{ for all } 1 \leq j \leq m\}.$$

Therefore, it suffices to show that

$$\ker(\partial^1) \supseteq \{T \in \text{SRT}(\underline{\alpha}) \mid T_j^{1+\delta_{j,m}} > T_{m+k_j-1}^1 \text{ for all } 1 \leq j \leq m\}.$$

Let $T \in \{T \in \text{SRT}(\underline{\alpha}) \mid T_j^{1+\delta_{j,m}} > T_{m+k_j-1}^1 \text{ for all } 1 \leq j \leq m\}$. For every $1 \leq j \leq m$, there exists $j' > j$ such that $\text{end}(\mathbf{w}_{T;j}) = T_{j'}^{1+\delta_{j',m}}$. By definition, one has

$$T_{j'}^{1+\delta_{j',m}} > T_{m+k_{j'}-1}^1 > T_{m+k_j-1}^1,$$

so $\mathcal{P}(\mathbf{A}_{T;j}) = \emptyset$. By definition, $\tau_{T;j} = 0$, and thus $T \in \ker(\partial^1)$.

Let us show $\ker(\partial^1) \subseteq \epsilon(\mathcal{V}_\alpha)$. Suppose that there exists $x \in \ker(\partial^1) \setminus \epsilon(\mathcal{V}_\alpha)$. Let $x = \sum_{T \in \text{SRT}(\underline{\alpha})} c_T T$ with $c_T \in \mathbb{C}$. Since $\partial^1(T) = 0$ for all T satisfying that $T_j^{1+\delta_{j,m}} > T_{m+k_j-1}^1$ ($1 \leq j \leq m$), all T s in the expansion of x are contained in $\Theta(\mathcal{V}_\alpha)$ (see equation (4.1)). Define

$$\text{supp}(x) := \{T \in \Theta(\mathcal{V}_\alpha) \mid c_T \neq 0\}$$

and choose any tableau U in $\text{supp}(x)$ such that $\mathbf{w}(U)$ is maximal in $\{\mathbf{w}(T) : T \in \text{supp}(x)\}$ with respect to the Bruhat order. Let

$$J := \{j \in [m] \mid \mathcal{P}(\mathbf{A}_{U;j}) \neq \emptyset\} \text{ and } \tau_0 := \tau_{U;\max(J);A_{U;\max(J)}^1.$$

It should be noted that J is nonempty because $U \in \Theta(\mathcal{V}_\alpha)$, and the coefficient of τ_0 is nonzero in the expansion of $\partial^1(U)$ in terms of $\bigcup_{1 \leq j \leq m} \text{SRT}(\underline{\alpha}_{(j)})$. Note that $\partial^1(x) = \partial^1(c_U U) + \partial^1(x - c_U U)$ and

$$\begin{aligned} \partial^1(x - c_U U) &= \sum_{T \in \text{supp}(x) \setminus \{U\}} c_T \left(\sum_{1 \leq j \leq m} \tau_{T;j} \right) \\ &= \sum_{T \in \text{supp}(x) \setminus \{U\}} c_T \left(\sum_{1 \leq j \leq m} \sum_{A \in \mathcal{P}(A_{T;j})} \text{sgn}(A) \tau_{T;j;A} \right). \end{aligned}$$

We claim that there is no triple (T, j, A) with $T \in \text{supp}(x) \setminus \{U\}$, $1 \leq j \leq m$ and $A \in \mathcal{P}(A_{T;j})$ such that $\tau_{T;j;A} = \tau_0$. Suppose not: that is, $\tau_0 = \tau_{T;j;A}$ for some (T, j, A) . Comparing the shapes of τ_0 and $\tau_{T;j;A}$, we see that j must be $\max(J)$. Let $\mathbf{w}(T) = w_1 w_2 \cdots w_n$. According to the definition of $\mathbf{w}_{T;\max(J)}$ in equation (4.3), it is a decreasing subword $w_{u_1} w_{u_2} \cdots w_{u_l}$ of $\mathbf{w}(T)$ subject to the conditions

$$w_{u_r} < w_i \quad \text{for all } 1 \leq r < l \text{ and } u_r < i < u_{r+1}. \tag{6.15}$$

Since $\tau_{T;\max(J);A} = \tau_0$, one has that

$$\mathbf{w}(T) = \mathbf{w}(U) \cdot (u_1 u_l)(u_1 u_{l-1}) \cdots (u_1 u_2),$$

where $\mathbf{w}(T), \mathbf{w}(U)$ are viewed as permutations and $(a b)$ denotes a transposition. For $\sigma \in \Sigma_n$ and $a, b \in [n]$, it is stated in [8, Lemma 2.1.4] that $\sigma < \sigma \cdot (a b)$ and $\ell(\sigma \cdot (a b)) = \ell(\sigma) + 1$ if and only if $\sigma(a) < \sigma(b)$ and there is no c such that $\sigma(a) < \sigma(c) < \sigma(b)$. Here $<$ is the Bruhat order. Combining this with equation (6.15) yields that $\mathbf{w}(U) < \mathbf{w}(T)$. This contradicts the maximality of U ; thus our claim is verified. It tells us that the coefficient of τ_0 in the expansion of $\partial^1(x)$ in terms of $\bigcup_{1 \leq j \leq m} \text{SRT}(\underline{\alpha}_{(j)})$ is nonzero, which is absurd by the assumption that $x \in \ker(\partial^1)$. Consequently, we can conclude that there is no $x \in \ker(\partial^1) \setminus \epsilon(\mathcal{V}_\alpha)$.

(c) Observe the following $H_n(0)$ -module isomorphisms:

$$\begin{aligned} \text{soc} \left(\bigoplus_{1 \leq j \leq m} \mathbf{P}_{\underline{\alpha}_{(j)}} \right) &\stackrel{\text{Theorem 2.3}}{\cong} \bigoplus_{1 \leq j \leq m} \bigoplus_{\beta \in [\underline{\alpha}_{(j)}]} \text{soc}(\mathbf{P}_\beta) \cong \bigoplus_{1 \leq j \leq m} \bigoplus_{\beta \in [\underline{\alpha}_{(j)}]} \mathbb{C} T_\beta^{\leftarrow} \\ &\stackrel{\text{Lemma 6.8}}{\cong} \mathbb{C} \left(\bar{\pi}_{\mathbf{w}_0(\beta;j)} \cdot T_{\beta;\underline{\alpha}_{(j)}}^{\leftarrow} \right) \end{aligned}$$

Hence our assertion can be verified by showing that $\bar{\pi}_{\mathbf{w}_0(\beta;j)} \cdot T_{\beta;\underline{\alpha}_{(j)}}^{\leftarrow} \in \text{Im}(\bar{\partial}^1)$ for $1 \leq j \leq m$ and $\beta \in [\underline{\alpha}_{(j)}]$. Let us fix $j \in [m]$ and $\beta \in [\underline{\alpha}_{(j)}]$. To begin with, we note that

$$\bar{\pi}_{\mathbf{w}_0(\beta;j)} \cdot T_{\beta;\underline{\alpha}_{(j)}}^{\leftarrow} = \sum_{\sigma \leq_L \mathbf{w}_0(\beta;j)} (-1)^{\ell(\mathbf{w}_0(\beta;j)) - \ell(\sigma)} \pi_\sigma \cdot T_{\beta;\underline{\alpha}_{(j)}}^{\leftarrow}. \tag{6.16}$$

According to the definition of $\mathbf{w}_0(\beta; j)$, we divide into the following two cases.

Case 1: $\min(J_{\beta;\underline{\alpha}_{(j)}}) > \ell(\alpha)$. For $\sigma \leq_L \mathbf{w}_0(\beta; j) = w_0(\widehat{J}_{\beta;\underline{\alpha}_{(j)}})$, it holds that

$$\begin{aligned} T(\sigma)_j^{1+\delta_{j,m}} &= |S'_{k-1}| + 1, \\ T(\sigma)_{m+k_j-1}^1 &= |S'_{k-1}| + 2 \text{ and} \\ T(\sigma)_{j'}^{1+\delta_{j',m}} &> T(\sigma)_{m+k_{j'}-1}^1 \quad \text{if } 1 \leq j' \leq m \text{ and } j' \neq j. \end{aligned} \tag{6.17}$$

Moreover, the definition of $T(\sigma)$ says that

$$\mathcal{P}(A_{T(\sigma);j}) = \left\{ A^1 := \left[|S'_{k-1}| + 2, |S'_{k-1}| + |S'_{k_0}| \right] \right\}. \tag{6.18}$$

Putting these together, we can derive the following equalities:

$$\begin{aligned} \overline{\partial^1}(T(\sigma) + \epsilon(\mathcal{V}_\alpha)) &= \sum_{1 \leq r \leq m} \tau_{T(\sigma);r} \\ &= \tau_{T(\sigma);j} \quad (\text{by equation (6.17)}) \\ &= \tau_{T(\sigma);j;A^1} \quad (\text{by equation (6.18)}). \end{aligned} \tag{6.19}$$

Since $\tau_{T(\sigma);j;A^1} = \pi_\sigma \cdot \tau_{T(\text{id});j;A^1}$ and $\tau_{T(\text{id});j;A^1} = T_{\beta;\underline{\alpha}(j)}^{\leftarrow}$, we see that

$$\overline{\partial^1}(T(\sigma) + \epsilon(\mathcal{V}_\alpha)) = \pi_\sigma \cdot T_{\beta;\underline{\alpha}(j)}^{\leftarrow}. \tag{6.20}$$

Finally, putting equations (6.16) and (6.20) together yields that

$$\overline{\pi}_{\mathbf{w}_0(\beta;j)} \cdot T_{\beta;\underline{\alpha}(j)}^{\leftarrow} = \sum_{\sigma \leq_L \mathbf{w}_0(\beta;j)} (-1)^{\ell(\mathbf{w}_0(\beta;j)) - \ell(\sigma)} \overline{\partial^1}(T(\sigma) + \epsilon(\mathcal{V}_\alpha)),$$

which verifies the assertion.

Case 2: $\min(j; \beta; \underline{\alpha}(j)) \leq \ell(\alpha)$. Let $\sigma \leq_L \mathbf{w}_0(\beta; j)$. Since

$$\mathbf{w}_0(\beta; j) = w_0([\ell(\alpha)]; |S'_{k_0}|) \cdot w_0(\widehat{j; \beta; \underline{\alpha}(j)}) \text{ and } \min(\widehat{j; \beta; \underline{\alpha}(j)}) > \ell(\alpha) + 1,$$

we can write σ as $\sigma' \sigma''$ for some $\sigma' \in (\Sigma_n)_{\widehat{j; \beta; \underline{\alpha}(j)}}$ and $\sigma'' \in (\Sigma_n)_{[\ell(\alpha)]}^{(|S'_{k_0}|)}$. Therefore, the right-hand side of equation (6.16) can be rewritten as

$$\sum_{\sigma \leq_L \mathbf{w}_0(\beta;j)} (-1)^{\ell(w_0(\widehat{j; \beta; \underline{\alpha}(j)))) + \ell(w_0([\ell(\alpha)]; |S'_{k_0}|)) - (\ell(\sigma') + \ell(\sigma''))} \pi_{\sigma'} \pi_{\sigma''} \cdot T_{\beta;\underline{\alpha}(j)}^{\leftarrow}. \tag{6.21}$$

Since $\{\sigma \in \Sigma_n \mid \sigma \leq_L \mathbf{w}_0(\beta; j)\}$ can be decomposed into

$$\bigsqcup_{\sigma' \in (\Sigma_n)_{\widehat{j; \beta; \underline{\alpha}(j)}}} \bigsqcup_{\sigma'' \in (\Sigma_n)_{[\ell(\alpha)]}^{(|S'_{k_0}|)}} \{\sigma' \sigma''\},$$

equation (6.21) can also be rewritten as

$$\sum_{\sigma' \in (\Sigma_n)_{\widehat{j; \beta; \underline{\alpha}(j)}}} (-1)^{\mathcal{N}(\sigma')} \pi_{\sigma'} \underbrace{\sum_{\sigma'' \in (\Sigma_n)_{[\ell(\alpha)]}^{(|S'_{k_0}|)}} (-1)^{\mathcal{M}(\sigma'')} \pi_{\sigma''} \cdot T_{\beta;\underline{\alpha}(j)}^{\leftarrow}}_{(P)}. \tag{6.22}$$

Here we are using the notation

$$\mathcal{N}(\sigma') := \ell(w_0(\widehat{j; \beta; \underline{\alpha}(j)))) - \ell(\sigma') \quad \text{and} \quad \mathcal{M}(\sigma'') := \ell(w_0([\ell(\alpha)]; |S'_{k_0}|)) - \ell(\sigma'').$$

Note that $\ell(\alpha) - |S'_{k_0}| + 2 = |S'_{k-1}| + 1$ since $\ell(\alpha) + 1 = |S'_{k_0}| + |S'_{k-1}|$. In view of equations (6.9) and (6.11), we see that the summation (P) in equation (6.22) equals

$$\sum_{1 \leq u \leq |S'_{k-1}| + 1} \sum_{\zeta \in (\Sigma_n)_{[u+1, \ell(\alpha)]}^{(|S'_{k_0}| + u - 1)}} (-1)^{\mathcal{M}(\zeta \Delta_u)} \pi_\zeta \pi_{\Delta_u} \cdot T_{\beta;\underline{\alpha}(j)}^{\leftarrow}.$$

For each $1 \leq u \leq |S'_{k-1}| + 1$, we claim that

$$\sum_{\substack{\zeta \in (\Sigma_n) \\ (|S'_{k_0}|+u-1) \\ [u+1, \ell(\alpha)]}} (-1)^{\mathcal{M}(\zeta \Delta_u)} \pi_{\zeta \Delta_u} \cdot T_{\beta; \underline{\alpha}(j)}^{\leftarrow} = (-1)^{|S'_{k-1}|-u} \partial^1(T(\Delta_u)),$$

which will give rise to

$$\bar{\pi}_{w_0(\beta; j)} \cdot T_{\beta; \underline{\alpha}(j)}^{\leftarrow} \in \text{Im}(\partial^1).$$

The last of the proof will be devoted to the verification of this claim. We fix $u \in [1, |S'_{k-1}| + 1]$ and observe that

$$T(\Delta_u)(S_{k_0}) = [\ell(\alpha) + 1] \setminus \{u\} \text{ and} \\ \min(T(\Delta_u)(S_{k_{j'}})) > \ell(\alpha) + 1 \quad \text{if } 1 \leq j' \leq m \text{ and } j' \neq j.$$

This implies that $T(\Delta_u)_{j'}^{1+\delta_{j',m}} > T(\Delta_u)_{m+k_{j'}-1}^1$, and therefore

$$\partial^1(T(\Delta_u)) = \tau_{T(\Delta_u); j} = \sum_{A \in \mathcal{P}(\mathbf{A}_{T(\Delta_u); j})} \text{sgn}(A) \tau_{T(\Delta_u); j; A}. \tag{6.23}$$

Combining Lemma 6.11 with equation (6.6) shows that the summation given in the last term is nonzero. In what follows, we transform this summation into a form suitable for proving our claim. For this purpose, we need to analyse $\mathcal{P}(\mathbf{A}_{T(\Delta_u); j})$. Since $\mathbf{A}_{T(\Delta_u); j} = [u + 1, \ell(\alpha) + 1]$ and $\ell(\alpha) - k_j + 1 = |S'_{k_0}| - 1$, it follows that

$$\mathcal{P}(\mathbf{A}_{T(\Delta_u); j}) = \binom{[u + 1, \ell(\alpha) + 1]}{|S'_{k_0}| - 1}.$$

Thus we have the natural bijection

$$\psi : \mathcal{P}(\mathbf{A}_{T(\Delta_u); j}) \rightarrow (\Sigma_n)_{[\ell(\alpha)-u]}^{(|S'_{k_0}|-1)}, \quad A = \{a_1 < a_2 < \dots < a_{|S'_{k_0}|-1}\} \mapsto \psi(A),$$

where $\psi(A)$ denotes the permutation in $(\Sigma_n)_{[\ell(\alpha)-u]}^{(|S'_{k_0}|-1)}$ such that $\psi(A)(i) = a_i - u$ for $1 \leq i \leq |S'_{k_0}| - 1$. Recall that there is a natural right $\Sigma_{|\mathbf{A}_{T(\Delta_u); j}|}$ -action on $\mathbf{A}_{T(\Delta_u); j}$ given by equation (4.4). Put

$$A^0 := [u + 1, u + |S'_{k_0}| - 1].$$

Since $|\mathbf{A}_{T(\Delta_u); j}| = \ell(\alpha) - u + 1$, we may identify $\Sigma_{|\mathbf{A}_{T(\Delta_u); j}|}$ with $(\Sigma_n)_{[\ell(\alpha)-u]}$. Note that $\psi(A)$ is the unique permutation in $(\Sigma_n)_{[\ell(\alpha)-u]}^{(|S'_{k_0}|-1)}$ that gives A^0 when acting on A : that is, $A \cdot \psi(A) = A^0$. Since

$$A^0 \cdot \psi(A)^{-1} = (A_{T(\Delta_u); j}^1 \cdot w_0([\ell(\alpha) - u]; |S'_{k_0}| - 1)^{-1}) \cdot \psi(A)^{-1},$$

we have that

$$\text{sgn}(A) = (-1)^{\ell(w_0([\ell(\alpha)-u]; |S'_{k_0}|-1)) - \ell(\psi(A))}.$$

Applying this identity to equation (6.23) yields that

$$\partial^1(T(\Delta_u)) = \sum_{A \in \mathcal{P}(\mathbf{A}_{T(\Delta_u); j})} (-1)^{\ell(w_0([\ell(\alpha)-u]; |S'_{k_0}|-1)) - \ell(\psi(A))} \tau_{T(\Delta_u); j; A}. \tag{6.24}$$

Consider the bijection

$$\theta_u : (\Sigma_n)^{(|S'_{k_0}|-1)}_{[\ell(\alpha)-u]} \rightarrow (\Sigma_n)^{(|S'_{k_0}|-1+u)}_{[u+1, \ell(\alpha)]}, \quad s_i \mapsto s_{i+u}.$$

From the constructions of $T(\Delta_u)$ and $\tau_{T(\Delta_u);j;A^0}$, we can derive the identities

$$\tau_{T(\Delta_u);j;A} = \tau_{T(\Delta_u);j;(A^0 \cdot \psi(A)^{-1})} = \pi_{\theta_u(\psi(A))} \cdot \tau_{T(\Delta_u);j;A^0} = \pi_{\theta_u(\psi(A))} \pi_{\Delta_u} \cdot T_{\beta; \underline{\alpha}(j)}^{\leftarrow}. \tag{6.25}$$

As a consequence,

$$\begin{aligned} \partial^1(T(\Delta_u)) &\stackrel{(6.24)}{=} \sum_{A \in \mathcal{P}(\mathbf{A}_{T(\Delta_u);j})} (-1)^{\ell(w_0([\ell(\alpha)-u]; |S'_{k_0}|-1)) - \ell(\psi(A))} \tau_{T(\Delta_u);j;A} \\ &\stackrel{(6.25)}{=} \sum_{A \in \mathcal{P}(\mathbf{A}_{T(\Delta_u);j})} (-1)^{\ell(w_0([\ell(\alpha)-u]; |S'_{k_0}|-1)) - \ell(\theta_u(\psi(A)))} \pi_{\theta_u(\psi(A))} \pi_{\Delta_u} \cdot T_{\beta; \underline{\alpha}(j)}^{\leftarrow}. \end{aligned}$$

Making use of the bijection $\theta_u \circ \psi : \mathcal{P}(\mathbf{A}_{T(\Delta_u);j}) \rightarrow (\Sigma_n)^{(|S'_{k_0}|-1+u)}_{[u+1, \ell(\alpha)]}$, we can rewrite the second summation as

$$\sum_{\xi \in (\Sigma_n)^{(|S'_{k_0}|-1+u)}_{[u+1, \ell(\alpha)]}} (-1)^{\ell(w_0([\ell(\alpha)-u]; |S'_{k_0}|-1)) - \ell(\xi)} \pi_{\xi} \pi_{\Delta_u} \cdot T_{\beta; \underline{\alpha}(j)}^{\leftarrow}. \tag{6.26}$$

Note that

$$\begin{aligned} \ell(w_0([\ell(\alpha)-u]; |S'_{k_0}|-1)) - \ell(\zeta) &= (|S'_{k_0}|-1)(\ell(\alpha)-u - |S'_{k_0}|-1) - \ell(\zeta) \\ &= (|S'_{k_0}|-1)(|S'_{k_0}|-1-u) - \ell(\zeta) \\ &= \mathcal{M}(\zeta \Delta_u) - |S'_{k_0}|-1+u. \end{aligned}$$

By substituting $\mathcal{M}(\zeta \Delta_u) - |S'_{k_0}|-1+u$ for $\ell(w_0([\ell(\alpha)-u]; |S'_{k_0}|-1)) - \ell(\zeta)$ in equation (6.26), we finally obtain that

$$\partial^1(T(\Delta_u)) = (-1)^{|S'_{k_0}|-1-u} \sum_{\zeta \in (\Sigma_n)^{(|S'_{k_0}|-1+u)}_{[u+1, \ell(\alpha)]}} (-1)^{\mathcal{M}(\zeta \Delta_u)} \pi_{\zeta} \pi_{\Delta_u} \cdot T_{\beta; \underline{\alpha}(j)}^{\leftarrow},$$

as required.

(d) It is well known that

$$\text{Ext}_{H_n(0)}^1(\mathbf{F}_{\beta}, \mathcal{V}_{\alpha}) = \text{Hom}_{H_n(0)}(\mathbf{F}_{\beta}, \Omega^{-1}(\mathcal{V}_{\alpha}))$$

(see [3, Corollary 2.5.4]). This immediately yields that

$$\dim \text{Ext}_{H_n(0)}^1(\mathbf{F}_{\beta}, \mathcal{V}_{\alpha}) = [\text{soc}(\Omega^{-1}(\mathcal{V}_{\alpha})) : \mathbf{F}_{\beta}].$$

By (c), one sees that $\text{soc}(\Omega^{-1}(\mathcal{V}_{\alpha}))$ equals the socle of $\bigoplus_{1 \leq j \leq m} \mathbf{P}_{\underline{\alpha}(j)}$. So we are done. □

7. Further avenues

(a) For each $\alpha \models n$, let

$$P_1 \xrightarrow{\partial_1} \mathbf{P}_{\alpha} \xrightarrow{\epsilon} \mathbf{F}_{\alpha} \longrightarrow 0 \tag{7.1}$$

be a minimal projective presentation of \mathbf{F}_α . From [3, Corollary 2.5.4], we know that $\dim \text{Ext}_{H_n(0)}^1(\mathbf{F}_\alpha, \mathbf{F}_\beta)$ counts the multiplicity of \mathbf{P}_β in the decomposition of P_1 into indecomposable modules, equivalently,

$$P_1 \cong \bigoplus_{\beta \models n} \mathbf{P}_\beta^{\dim \text{Ext}_{H_n(0)}^1(\mathbf{F}_\alpha, \mathbf{F}_\beta)}.$$

This dimension has been computed in [14, Section 4] and [16, Theorem 5.1]. However, to the best of the authors' knowledge, no description for ∂_1 is available yet. It would be nice to find an explicit description of ∂_1 , especially in a combinatorial manner. If this is done successfully, by taking an anti-automorphism twist introduced in [21, Section 3.4] to equation (7.1), we can also derive a minimal injective presentation for \mathbf{F}_α .

(b) Besides dual immaculate functions, the problem of constructing $H_n(0)$ -modules has been considered for the following quasisymmetric functions: the *quasisymmetric Schur functions* in [27, 28], the *extended Schur functions* in [26], the *Young row-strict quasisymmetric Schur functions* in [2], the *Young quasisymmetric Schur functions* in [12] and the images of all these quasisymmetric functions under certain involutions on QSym in [21]. Although these modules are built in a very similar way, their homological properties have not been well studied. The study of their projective and injective presentations will be pursued in the near future with appropriate modifications to the method used in this paper.

(c) By virtue of Lemma 5.2 and Lemma 5.3, we have a combinatorial description for $\dim \text{Hom}_{H_n(0)}(\mathbf{P}_\alpha, \mathcal{V}_\beta)$. However, no similar one is known for $\dim \text{Hom}_{H_n(0)}(\mathcal{V}_\alpha, \mathcal{V}_\beta)$ except when $\beta \leq_l \alpha$. It would be interesting to find such a description that holds for all $\alpha, \beta \models n$.

Acknowledgements. The authors are grateful to the anonymous referees for their careful readings of the manuscript and valuable advice. And the authors would like to thank So-Yeon Lee for helping with computer programming. This work benefited from computations using SAGEMATH.

Conflicts of Interest. None.

Funding statement. The first author was supported by a National Research Foundation of Korea (NRF) grant funded by the Korean government (No. NRF-2019R1C1C1010668 and No. NRF-2020R1A5A1016126). The second author was supported by an NRF grant funded by the Korean Government (No. NRF-2019R1A2C4069647 and No. NRF-2020R1A5A1016126). The third author was supported by the Basic Science Research Program through the NRF, funded by the Ministry of Education (No. NRF-2019R111A1A01062658). The fourth author was supported by an NRF grant funded by the Korean Government (No. NRF-2020R1F1A1A01071055).

References

- [1] M. Auslander, I. Reiten, and S. Smalø. *Representation Theory of Artin Algebras*, volume 36 of Cambridge Studies in Advanced Mathematics. (Cambridge University Press, Cambridge, 1995).
- [2] J. Bardwell and D. Searles. '0-Hecke modules for Young row-strict quasisymmetric Schur functions', *European J. Combin.*, **102** (2022). doi:10.1016/j.ejc.2021.103494.
- [3] D. J. Benson. *Representations and Cohomology, I: Basic Representation Theory of Finite Groups and Associative Algebras*, volume 30 of Cambridge Studies in Advanced Mathematics. (Cambridge University Press, Cambridge, 1991).
- [4] C. Berg, N. Bergeron, F. Saliola, L. Serrano, and M. Zabrocki. 'A lift of the Schur and Hall-Littlewood bases to non-commutative symmetric functions', *Canad. J. Math.*, **66**(3) (2014), 525–565. doi:10.4153/cjm-2013-013-0.
- [5] C. Berg, N. Bergeron, F. Saliola, L. Serrano, and M. Zabrocki. 'Indecomposable modules for the dual immaculate basis of quasi-symmetric functions', *Proc. Amer. Math. Soc.*, **143**(3) (2015), 991–1000. doi:10.1090/s0002-9939-2014-12298-2.
- [6] C. Berg, N. Bergeron, F. Saliola, L. Serrano, and M. Zabrocki. 'Multiplicative structures of the immaculate basis of non-commutative symmetric functions', *J. Combin. Theory Ser. A*, **152** (2017), 10–44. doi:10.1016/j.jcta.2017.05.003.
- [7] N. Bergeron, J. Sánchez-Ortega, and M. Zabrocki. 'The Pieri rule for dual immaculate quasi-symmetric functions', *Ann. Comb.*, **20**(2) (2016), 283–300. doi:10.1007/s00026-016-0303-3.
- [8] A. Björner and F. Brenti. *Combinatorics of Coxeter groups, volume 231 of Graduate Texts in Mathematics*. (Springer, New York, 2005).
- [9] M. Cabanes. 'Extension groups for modular Hecke algebras', *J. Fac. Sci. Univ. Tokyo Sect. IA Math.*, **36** (1989), 347–362. doi:10.15083/00039425.

- [10] J. M. Campbell. ‘Bipieri tableaux’, *Australas. J. Combin.*, **66** (2016), 66–103.
- [11] J. M. Campbell. ‘The expansion of immaculate functions in the ribbon basis’, *Discrete Math.*, **340**(7) (2017), 1716–1726. doi:[10.1016/j.disc.2016.09.025](https://doi.org/10.1016/j.disc.2016.09.025).
- [12] S.-I. Choi, Y.-H. Kim, S.-Y. Nam, and Y.-T. Oh. ‘The projective cover of tableau-cyclic indecomposable $H_n(0)$ -modules’, *Trans. Amer. Math. Soc.*, **375**(11) (2022), 7747–7782. doi:[10.1090/tran/8693](https://doi.org/10.1090/tran/8693).
- [13] T. Denton. ‘A combinatorial formula for orthogonal idempotents in the 0-Hecke algebra of the symmetric group’, *Electron. J. Combin.*, **18**(1) (2011), Paper 28, 20. doi:[10.37236/515](https://doi.org/10.37236/515).
- [14] G. Duchamp, F. Hivert, and J.-Y. Thibon. ‘Noncommutative symmetric functions. VI. Free quasi-symmetric functions and related algebras’, *Internat. J. Algebra Comput.*, **12**(5) (2002), 671–717. doi:[10.1142/s0218196702001139](https://doi.org/10.1142/s0218196702001139).
- [15] G. Duchamp, D. Krob, B. Leclerc, and J.-Y. Thibon. ‘Fonctions quasi-symétriques, fonctions symétriques non commutatives et algèbres de Hecke à $q = 0$ ’, *C. R. Acad. Sci. Paris Sér. I Math.*, **322**(2) (1996), 107–112.
- [16] M. Fayers. ‘0-Hecke algebras of finite Coxeter groups’, *J. Pure Appl. Algebra*, **199**(1–3) (2005), 27–41. doi:[10.1016/j.jpaa.2004.12.001](https://doi.org/10.1016/j.jpaa.2004.12.001).
- [17] A. L. L. Gao and A. L. B. Yang. ‘A bijective proof of the hook-length formula for standard immaculate tableaux’, *Proc. Amer. Math. Soc.*, **144**(3) (2016), 989–998. doi:[10.1090/proc/12899](https://doi.org/10.1090/proc/12899).
- [18] D. Grinberg. ‘Dual creation operators and a dendriform algebra structure on the quasisymmetric functions’, *Canad. J. Math.*, **69**(1) (2017), 21–53. doi:[10.4153/cjm-2016-018-8](https://doi.org/10.4153/cjm-2016-018-8).
- [19] F. Hivert, J.-C. Novelli, and J.-Y. Thibon. ‘Yang-Baxter bases of 0-Hecke algebras and representation theory of 0-Ariki–Koike–Shoji algebras’, *Adv. Math.*, **205**(2) (2006), 504–548. doi:[10.1016/j.aim.2005.07.016](https://doi.org/10.1016/j.aim.2005.07.016).
- [20] J. Huang. ‘A tableau approach to the representation theory of 0-Hecke algebras’, *Ann. Comb.*, **20**(4) (2016), 831–868. doi:[10.1007/s00026-016-0338-5](https://doi.org/10.1007/s00026-016-0338-5).
- [21] W.-S. Jung, Y.-H. Kim, S.-Y. Lee, and Y.-T. Oh. ‘Weak Bruhat interval modules of the 0-Hecke algebra’, *Math. Z.*, **301** (2022), 3755–3786. doi:[10.1007/s00209-022-03025-4](https://doi.org/10.1007/s00209-022-03025-4).
- [22] D. Krob and J.-Y. Thibon. ‘Noncommutative symmetric functions. IV. Quantum linear groups and Hecke algebras at $q = 0$ ’, *J. Algebraic Combin.*, **6**(4) (1997), 339–376. doi:[10.1023/A:1008673127310](https://doi.org/10.1023/A:1008673127310).
- [23] T. Y. Lam. *Lectures on Modules and Rings*, volume 189 of Graduate Texts in Mathematics. (Springer-Verlag, New York, 1999).
- [24] S. Mason and D. Searles. ‘Lifting the dual immaculate functions’, *J. Combin. Theory Ser. A*, **184** (2021), Paper No. 105511, 52. doi:[10.1016/j.jcta.2021.105511](https://doi.org/10.1016/j.jcta.2021.105511).
- [25] P. N. Norton. ‘0-Hecke algebras’, *J. Austral. Math. Soc. Ser. A*, **27**(3) (1979), 337–357. doi:[10.1017/S1446788700012453](https://doi.org/10.1017/S1446788700012453).
- [26] D. Searles. ‘Indecomposable 0-Hecke modules for extended Schur functions’, *Proc. Amer. Math. Soc.*, **148**(5) (2020), 1933–1943. doi:[10.1090/proc/14879](https://doi.org/10.1090/proc/14879).
- [27] V. Tewari and S. van Willigenburg. ‘Modules of the 0-Hecke algebra and quasisymmetric Schur functions’, *Adv. Math.*, **285** (2015), 1025–1065. doi:[10.1016/j.aim.2015.08.012](https://doi.org/10.1016/j.aim.2015.08.012).
- [28] V. Tewari and S. van Willigenburg. ‘Permuted composition tableaux, 0-Hecke algebra and labeled binary trees’, *J. Combin. Theory Ser. A*, **161** (2019), 420–452. doi:[10.1016/j.jcta.2018.09.003](https://doi.org/10.1016/j.jcta.2018.09.003).