



RESEARCH ARTICLE

Two-variable fibrations, factorisation systems and ∞ -categories of spans

Rune Haugseng¹, Fabian Hebestreit², Sil Linskens³ and Joost Nuiten⁴

¹Institutt for matematiske fag, Norges teknisk-naturvitenskapelige universitet, Alfred Getz' vei 1, 7034 Trondheim, Norway;
E-mail: rune.haugsgeng@ntnu.no

²Department of Mathematics, University of Aberdeen, Fraser Noble Building, Elphinstone Road, AB24 3UE Aberdeen, Scotland; E-mail: fabian.hebestreit@abdn.ac.uk

³Mathematisches Institut, Rheinische Friedrich-Wilhelms-Universität Bonn, Endenicher Allee 60, 53115 Bonn, Germany;
E-mail: linskens@math.uni-bonn.de

⁴Institut de Mathématiques de Toulouse, Université Toulouse III Paul Sabatier, 118 Route de Narbonne, 31062 Toulouse, France; E-mail: joost.nuiten@math.univ-toulouse.fr

Received: 4 July 2022; Revised: 20 September 2023; Accepted: 15 October 2023

2020 Mathematics Subject Classification: Primary – 18N70; Secondary – 18N60, 18N65

Abstract

We prove a universal property for ∞ -categories of spans in the generality of Barwick's adequate triples, explicitly describe the cocartesian fibration corresponding to the span functor, and show that the latter restricts to a self-equivalence on the class of orthogonal adequate triples, which we introduce for this purpose.

As applications of the machinery we develop, we give a quick proof of Barwick's unfurling theorem, show that an orthogonal factorisation system arises from a cartesian fibration if and only if it forms an adequate triple (generalising work of Lanari), extend the description of dual (co)cartesian fibrations by Barwick, Glasman and Nardin to two-variable fibrations, explicitly describe parametrised adjoints (extending work of Torii), identify the orthofibration classifying the mapping category functor of an $(\infty, 2)$ -category (building on work of Abellán García and Stern), formally identify the unstraightenings of the identity functor on the ∞ -category of ∞ -categories with the (op)lax under-categories of a point, and deduce a certain naturality property of the Yoneda embedding (answering a question of Clausen).

Contents

1	Introduction	1
2	Adequate triples and ∞-categories of spans	5
3	Cartesian fibrations and ∞-categories of spans	16
4	Orthogonal adequate triples and their duals	25
5	Cartesian fibrations between orthogonal adequate triples	33
6	Dualisation and straightening of two-variable fibrations	41
7	(Op)lax arrow and twisted arrow ∞-categories	49
8	Naturality of the Yoneda embedding	59
A	Uniqueness of straightening and dualisation	62

1. Introduction

Categories of spans typically appear in algebra and geometry as a convenient way to encode co- and contravariant functorialities (transfer and restriction) and base change isomorphisms between these. For

© The Author(s), 2023. Published by Cambridge University Press. This is an Open Access article, distributed under the terms of the Creative Commons Attribution-NonCommercial-NoDerivatives licence (<https://creativecommons.org/licenses/by-nc-nd/4.0/>), which permits non-commercial re-use, distribution, and reproduction in any medium, provided the original work is unaltered and is properly cited. The written permission of Cambridge University Press must be obtained for commercial re-use or in order to create a derivative work.

example, span categories of finite G -sets classically appear in representation theory as the indexing categories of Mackey functors [Dr71]. In the ∞ -categorical setting, spans play an even more significant role because they often provide the only feasible method to organise base change isomorphisms in a homotopy-coherent way. As such, they naturally appear in equivariant homotopy theory (via the theory of spectral Mackey functors [Ba17, Na16]), in motivic homotopy theory [BH21] and in higher algebra [Cr11, Ha20a, EH20].

In each of these cases, one is interested in diagrams indexed by a certain ∞ -category of spans that is constructed informally as follows: from the data of an ∞ -category X , together with two classes of maps called *ingressive* (or forwards, denoted \dashrightarrow) and *egressive* (or backwards, denoted \dashleftarrow), one constructs an ∞ -category $\text{Span}(X)$ with the same objects as X and with morphisms from x to y given by spans

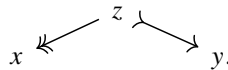

Composition proceeds by pullback of spans, which of course requires that pullbacks of ingressive and egressive maps exist and remain ingressive and egressive. From a geometric point of view, one can think of $\text{Span}(X)$ as an ∞ -category of (combinatorial) bordisms in X^{op} , the two legs of a span giving the two boundary inclusions. As such, span categories also arise in various situations as objects of interest in themselves. Notably, they appear in algebraic K -theory [Ba13, BGT13] and its hermitian refinements [Sc10, CDH+20] via Quillen’s \mathcal{Q} -construction [Qu73]; see, in particular, [RS19, CDH+20, HS21] for works on K -theory where such a geometric perspective on spans is brought to fruition.

The above informal description of $\text{Span}(X)$ has been substantiated by Barwick, who constructs an explicit functor sending each *adequate triple* (of an ∞ -category X and two classes of maps) to a quasi-category $\text{Span}(X)$ [Ba17]. The first purpose of this text is to study some further abstract properties of this construction of span ∞ -categories. For example, we give a description of span ∞ -categories by a universal property:

Theorem A. *There is an adjoint pair $\text{Tw}^r : \text{Cat} \rightleftarrows \text{AdTrip} : \text{Span}$, where $\text{Tw}^r(A)$ is the twisted arrow ∞ -category of A with the ingressive and egressive morphisms being those which induce equivalences in the target and source component, respectively.*

Here we follow the same notational conventions as in [HHLN23] and denote the ∞ -category of small ∞ -categories by Cat (and similarly that of ∞ -groupoids by Gpd , etc.). Let us point out that our proof of this result relies on a Segal space construction of span ∞ -categories, instead of the point-set approach of Barwick; a slightly different proof was sketched by Raskin in [Ra14]. Theorem A also has a 2-categorical upgrade, which identifies the diagram ∞ -categories $\text{Fun}(A, \text{Span}(X))$ with a span ∞ -category of the ∞ -category of diagrams $\text{Tw}^r(A) \rightarrow X$. This statement has already been applied in hermitian K -theory, where it forms the basis for the parametrised algebraic surgery of [HS21].

In addition, we give a description of the ‘universal span category’ (i.e., the cocartesian fibration classified by the functor $\text{Span} : \text{AdTrip} \rightarrow \text{Cat}$):

Theorem B. *The opposite of the lax under-category $* // \text{AdTrip}$ admits the structure of an adequate triple in which a map*

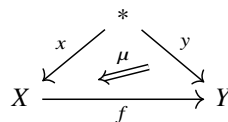

is egressive if $\mu : y \rightarrow f(x)$ is egressive, and ingressive if μ is ingressive and f is an equivalence. The natural map $\text{Span}((* // \text{AdTrip})^{\text{op}}) \rightarrow \text{AdTrip}$ extracting the morphisms underlying egressive maps (and inverting those underlying ingressive ones) is then equivalent to the cocartesian fibration classified by $\text{Span} : \text{AdTrip} \rightarrow \text{Cat}$.

As a consequence of Theorem B, we obtain a new proof of the main result of [BGN18], which asserts that the cocartesian unstraightening of a functor $F: B \rightarrow \text{Cat}$ can be constructed from its cartesian unstraightening via a span construction.

Note that the ∞ -category $\text{Span}(X)$ has the following features: the egressive arrows from X are reverted, the ingressive arrows from X are kept and each map factors uniquely as a ‘reverted-egressive’, followed by an ingressive map. This suggests that taking span ∞ -categories acts as an involution on adequate triples arising from (orthogonal) factorisation systems. The second part of the paper studies such *orthogonal* adequate triples, whose egressive and ingressive arrows form a factorisation system and in which all commuting squares of the form

$$\begin{array}{ccc}
 x' & \xrightarrow{\quad} & x \\
 \downarrow & & \downarrow \\
 y' & \xrightarrow{\quad} & y
 \end{array} \tag{1.1}$$

are cartesian. Our most significant result about these is the following:

Theorem C. *Taking span ∞ -categories gives rise to a C_2 -action on the full subcategory of orthogonal adequate triples*

$$\text{Span}^\perp: \text{AdTrip}^\perp \longrightarrow \text{AdTrip}^\perp.$$

The simplest example of an orthogonal adequate triple is given by a product $A \times B$, with ingressive maps coming from A and egressive maps coming from B . More generally, every cartesian fibration $p: X \rightarrow A$ defines the structure of an orthogonal adequate triple on X , for which a map is ingressive if it is p -cartesian and egressive if it is fibrewise (i.e. its image under p is invertible). In fact, every orthogonal adequate triple arises in this way:

Theorem D. *An orthogonal factorisation system arises from a cartesian fibration as the cartesian and fibrewise maps if and only if it forms an orthogonal adequate triple. Moreover, this construction restricts to an equivalence between the ∞ -category of orthogonal adequate triples and the ∞ -category of cartesian fibrations whose fibres have contractible realisation.*

This result extends previous work of Lanari [La19], who established such a correspondence for pointed cartesian fibrations (i.e., those whose base and total ∞ -category have a terminal object which is preserved by the fibration) and what he calls cartesian factorisation systems. Using the relation between orthogonal adequate triples and cartesian fibrations, the span duality from Theorem C also gives an auto-equivalence of the ∞ -category of cartesian fibrations. This reduces to the duality functor of Barwick, Glasman and Nardin from [BGN18].

Similarly, one can use Theorem C to obtain duality functors for fibrations over a product $A \times B$. For example, one can consider maps of orthogonal triples $p = (p_1, p_2): X \rightarrow A \times B$ such that

- (1) the ingressive maps of X are exactly the p -cartesian lifts of arrows in A ,
- (2) p_2 is a cocartesian fibration and for any square (1.1) in X where $x \rightarrow y$ is p_1 -cocartesian, the base change $x' \rightarrow y'$ is p_1 -cocartesian as well.

Such maps are called *orthofibrations* in [HHLN23], or *two-sided fibrations* in [RV22, Section 7.1], and can be straightened to functors $A^{\text{op}} \times B \rightarrow \text{Cat}$, which also correspond to cartesian fibrations over $A \times B^{\text{op}}$ via unstraightening. Using that Span^\perp sends $A \times B$ (with the adequate triple structure mentioned above) to $A \times B^{\text{op}}$, the dualisation of Theorem C also restricts to an equivalence

$$\text{Span}^\perp: \text{Ortho}(A, B) \simeq \text{Cart}(A \times B^{\text{op}}) \tag{1.2}$$

between orthofibrations and cartesian fibrations, taking opposite categories at the level of fibres. There are similar dualities for the various other types of two-variable fibrations considered in [HHLN23]; for

example, Theorem C also restricts to a duality between curved orthofibrations over $A \times B$ and op-Gray fibrations over $A \times B^{\text{op}}$ (see [HHLN23] or Section 6 for definitions), which under straightening [Lu09b] correspond to 2-functors out of the Gray tensor product $B \boxtimes A^{\text{op}}$.

Relying on Toën’s equivalence $\text{Aut}(\text{Cat}) \simeq C_2$ [To05], we extend another result from [BGN18] and show that any composite of dualisations and (un)straightenings as above is uniquely determined by its action on fibres:

Theorem E. *The three functors $\text{Cat}^{\text{op}} \times \text{Cat}^{\text{op}} \rightarrow \text{CAT}$ given by*

$$(A, B) \longmapsto \text{Fun}(A \times B, \text{Gpd}), \quad \text{Fun}(A \times B, \text{Cat}) \quad \text{and} \quad \text{Fun}(A \boxtimes B, \mathbf{Cat})$$

have automorphism groups \ast, C_2 and \ast , respectively. The nontrivial automorphism in the middle case is given by post-composition with $(-)^{\text{op}}: \text{Cat} \rightarrow \text{Cat}$. (Here \mathbf{Cat} denotes the $(\infty, 2)$ -category of ∞ -categories, as in [HHLN23].)

For example, this implies that the dualisation equivalence (1.2) arising from Theorem C coincides with the dualisation constructed in [HHLN23] using straightening and unstraightening (though this can also be deduced from Theorem B directly). As an application of this explicit dualisation for two-variable fibrations, we consider the fibrations classified by the enhanced mapping functor

$$\text{Hom}_{\mathbf{X}}: X^{\text{op}} \times X \rightarrow \text{Cat}$$

associated to an $(\infty, 2)$ -category \mathbf{X} with underlying ∞ -category X . On the one hand, this functor is classified by a cartesian fibration

$$(s, t): \text{Tw}^r(\mathbf{X}) \longrightarrow X \times X^{\text{op}}$$

from the *oplax twisted arrow ∞ -category* of \mathbf{X} , explicitly constructed in [AGS23]. We show (Theorem 7.21) that dually (and upon taking opposite categories), this functor also classifies the orthofibration

$$(s, t): \text{Ar}^{\text{opl}}(\mathbf{X}) \longrightarrow X \times X$$

from the ∞ -category underlying the *oplax arrow ∞ -category*, defined using the (in principle unrelated) Gray tensor product of Gagna, Harpaz and Lanari from [GHL21]. This is a typical example of an identification of dual fibrations which seems difficult to see by passing through a form of straightening and unstraightening (as in [HHLN23]).

In a different direction, Theorem E shows that straightening a cartesian fibration over $A \times B$ to a functor $A^{\text{op}} \times B^{\text{op}} \rightarrow \text{Cat}$ is naturally equivalent to straightening it first over A and then over B . This should not be surprising, but deducing it from the definitions does not seem entirely obvious (nevertheless, we provide a second proof as 6.20). As a consequence, we answer a recent question of Clausen:

Corollary F. *The Yoneda embedding $C \hookrightarrow \mathcal{P}(C)$ canonically extends to a natural transformation of functors $\text{Cat} \rightarrow \text{CAT}$ from the inclusion to the composite*

$$\text{Cat} \xrightarrow{\text{Fun}(-, \text{Gpd})} (\text{CAT}^{\text{R}})^{\text{op}} \simeq \text{CAT}^{\text{L}} \subseteq \text{CAT}.$$

Again, this result is certainly expected, and we were surprised to learn that it is apparently not contained in the literature. Let us point out that, essentially by definition, the Yoneda embedding does define a natural transformation to the functor $\mathcal{P}: \text{Cat} \rightarrow \text{CAT}$ defined using that $\mathcal{P}(C)$ is the free cocompletion of C . However, it is not a priori clear that this functor agrees with the one appearing in the corollary in a fashion compatible with the Yoneda embedding (but this follows from the result above as well).

Remark. Along with [HHLN23], this article is part of a recombination of our earlier preprints [Ha20b] and [HLN20]. In [HHLN23], we described the dualisation of two-variable fibrations, as well as its applications to monoidal and parametrised adjunctions, along the lines of [Ha20b]; these applications were also discussed in terms of the dualisation functor Span^\perp in [HLN20] (in particular, Proposition A and Theorem C in there). The results from [HLN20] concerning span ∞ -categories and the comparison of various straightening functors for two-variable fibrations (in particular, Theorem B and Corollary D there) are contained in the present paper.

Organisation

In Section 2, we redevelop Barwick's theory of span ∞ -categories for adequate triples in terms of complete Segal spaces and then discuss some further properties of the span construction in Section 3. In particular, here we prove Theorem A as Theorem 2.18 and deduce Theorem B as a corollary of Theorem 3.9.

We then introduce orthogonal adequate triples in Section 4 and establish Theorem C as Theorem 4.12. The relation between orthogonal adequate triples and fibrations is discussed in Section 5, where Theorem D is proven as Proposition 5.4. In Section 6, we show how Theorem C induces dualities between various types of two-variable fibrations considered in [HHLN23], we and use this to identify oplax arrow and twisted arrow ∞ -categories as duals in Section 7. We deduce Corollary F in the final Section 8 as Theorem 8.1.

Finally, the uniqueness of all these dualities (i.e., Theorem E) is derived in Appendix A as Theorem A.1.

Conventions

In order to declutter notation, we will write Gpd , Cat and Cat_2 for the ∞ -categories of ∞ -groupoids (or spaces), ∞ -categories and $(\infty, 2)$ -categories, respectively.

The letter ι will denote the core of an ∞ -category (i.e., the ∞ -groupoid spanned by its equivalences). By a subcategory of an ∞ -category we mean a functor such that the induced morphisms on mapping ∞ -groupoids and cores are inclusions of path components. A subcategory is *full* if the functor furthermore induces equivalences on mapping ∞ -groupoids, while it is *wide* if the functor induces an equivalence on cores. Similarly, a sub-2-category of an $(\infty, 2)$ -category is a functor inducing subcategory inclusions on mapping ∞ -categories and a monomorphism on underlying ∞ -groupoids; we say such a sub-2-category is *1-full* if it locally full (i.e., is given by full subcategory inclusions on mapping ∞ -categories).

Throughout, we shall use small caps such as Cat to indicate large variants of ∞ -categories and boldface such as \mathbf{Cat} to denote $(\infty, 2)$ -categories. We have also reserved sub- and superscripts on category names to refer to changes on morphisms (e.g., $\text{Cart}(A) \subseteq \text{Cart}^{\text{opl}}(A)$).

We will write $\text{Ar}(C)$ for the arrow ∞ -category $\text{Fun}([1], C)$ of an ∞ -category C , and $\text{Tw}^\ell(C)$ and $\text{Tw}^r(C)$ for the two versions of the twisted arrow category, geared so that the combined source-target map defines a left fibration in the former, and a right fibration in the latter case; see Example 2.8. Finally, we write $\Lambda_0[2]$ for the span category $1 \leftarrow 0 \rightarrow 2$ and $\Lambda_2[2]$ for the cospan.

2. Adequate triples and ∞ -categories of spans

In this section, we will review the theory of adequate triples and their associated span ∞ -categories, as developed by Barwick in [Ba17] under the name effective Burnside ∞ -categories. We will use the opportunity to present an alternate viewpoint on the material by translating the assertions along the equivalence between ∞ -categories and complete Segal ∞ -groupoids (i.e., complete Segal spaces). This will allow for simpler proofs with far less explicit combinatorics and will form the basis for our analysis of functors to span ∞ -categories in the next section.

Since composition in span ∞ -categories proceeds by pullback, one uses the following data as input for span ∞ -categories:

Definition 2.1. An *adequate triple* $(X, X_{\text{in}}, X^{\text{eg}})$ consists of an ∞ -category X together with two wide subcategories X_{in} and X^{eg} , whose morphisms are called *ingressive* (or *forwards*, denoted \succrightarrow) and *egressive* (or *backwards*, denoted \rightarrow), respectively, such that

- (1) for any ingressive morphism $f: y \succrightarrow x$ and any egressive morphism $g: x' \rightarrow x$, there exists a pullback

$$\begin{array}{ccc}
 y' & \xrightarrow{f'} & x' \\
 g' \downarrow & & \downarrow g \\
 y & \xrightarrow{f} & x,
 \end{array}$$

- (2) and in any such pullback, f' is again ingressive and g' egressive.

Squares whose horizontal arrows are ingressive and whose vertical arrows are egressive are called *ambigressive*, and *ambigressive cartesian* if they are furthermore pullback diagrams. A functor

$$F: (X, X_{\text{in}}, X^{\text{eg}}) \rightarrow (Y, Y_{\text{in}}, Y^{\text{eg}})$$

of adequate triples is given by a functor $F: X \rightarrow Y$ which preserves ambigressive pullbacks. Therefore, we may define AdTrip , the ∞ -category of adequate triples, as the subcategory of $\text{Fun}(\Lambda_2[2], \text{Cat})$ spanned by the adequate triples and those natural transformations whose evaluation at $2 \in \Lambda_2[2]$ preserves ambigressive pullback squares.

Note that being a natural transformation boils down to preserving ingressive and egressive maps, since these form subcategories. We shall often drop them from notation to avoid cluttering.

Notation 2.2. Given a morphism $p: Y \rightarrow X$ of adequate triples, we write $p_{\text{in}}: Y_{\text{in}} \rightarrow X_{\text{in}}$ and $p^{\text{eg}}: Y^{\text{eg}} \rightarrow X^{\text{eg}}$ for the restriction of p to ingressives and egressives.

Example 2.3. Let us record the following immediate examples:

- (1) For any wide subcategory T of an ∞ -category S , we have the adequate triples $(S, T, \iota S)$ and $(S, \iota S, T)$ where the ingressives are maps in T and the egressives are equivalences, and vice versa. In particular, for any ∞ -category S , we always have the adequate triples $(S, S, \iota S)$ and $(S, \iota S, S)$.
- (2) If S admits all pullbacks, we have the adequate triple (S, S, S) where all maps are both egressive and ingressive. This gives rise to a fully faithful embedding $\text{Cat}^{\text{pb}} \hookrightarrow \text{AdTrip}$ of the subcategory of Cat spanned by those ∞ -categories which admit pullbacks, and those functors which preserve pullbacks.
- (3) If $(X, X_{\text{in}}, X^{\text{eg}})$ is an adequate triple, then $X^{\text{ev}} = (X, X^{\text{eg}}, X_{\text{in}})$ is an adequate triple.

Lemma 2.4. *The ∞ -category of adequate triples admits all limits and one simply computes $\lim (X, X_{\text{in}}, X^{\text{eg}}) \simeq (\lim X, \lim X_{\text{in}}, \lim X^{\text{eg}})$ for every $X: I \rightarrow \text{AdTrip}$. Likewise, AdTrip has filtered colimits given by $\text{colim} (X, X_{\text{in}}, X^{\text{eg}}) \simeq (\text{colim} X, \text{colim} X_{\text{in}}, \text{colim} X^{\text{eg}})$.*

Proof. Since the limit of a natural wide subcategory inclusion remains a wide subcategory inclusion, $(\lim X, \lim X_{\text{in}}, \lim X^{\text{eg}})$ is indeed a triple of a category together with two wide subcategories (and likewise for filtered colimits). Notice that an ambigressive square in $\lim X$ is cartesian if and only if its image in each X_i is cartesian. Furthermore, a cospan $x \succrightarrow x' \leftarrow x''$ in $\lim X$ admits an ambigressive pullback if its images in each X_i do (in this case, those pullbacks assemble into an object of the limit). This implies that $\lim X$ is an adequate triple and that a map $Z \rightarrow \lim X$ preserves ambigressive pullback squares if and only if each composite $Z \rightarrow \lim X \rightarrow X_i$ does. This implies that the (pointwise) limit in $\text{Fun}(\Lambda_2[2], \text{Cat})$ also provides the limit in the subcategory $\text{AdTrip} \hookrightarrow \text{Fun}(\Lambda_2[2], \text{Cat})$.

A dual argument applies to the colimit of a filtered diagram. In this case, the image of an ambigressive pullback square in some X_i under the map $X_i \rightarrow \text{colim } X_i$ remains an ambigressive pullback (since at the level of mapping ∞ -groupoids, filtered colimits commute with pullbacks). Conversely, any cospan $x \rightarrow x' \leftarrow x''$ in $\text{colim } X$ arises as the image of a cospan in some X_i , whose pullback in X_i then provides the desired ambigressive pullback in $\text{colim } X$. It follows that $\text{colim } X$ is an adequate triple and that a map of triples $\text{colim } X \rightarrow Z$ preserves ambigressive pullback squares if and only if each $X_i \rightarrow \text{colim } X \rightarrow Z$ does. This implies that $\text{colim } X$ is also the colimit in the subcategory $\text{AdTrip} \hookrightarrow \text{Fun}(\Lambda_2[2], \text{Cat})$. \square

Lemma 2.5. *Let X and Y be two adequate triples and let us write $\text{Fun}_{\text{AdTrip}}(X, Y)$ for the full subcategory of $\text{Fun}(X, Y)$ spanned by the morphisms of adequate triples. Say a natural transformation $\tau: F \Rightarrow G$ is ingressive if it is pointwise ingressive in Y and for every egressive $f: x \rightarrow y$ in X , the square*

$$\begin{array}{ccc} F(x) & \xrightarrow{F(f)} & F(y) \\ \tau_x \downarrow & & \downarrow \tau_y \\ G(x) & \xrightarrow{G(f)} & G(y) \end{array}$$

is cartesian, and analogously for an egressive natural transformation. This endows $\text{Fun}_{\text{AdTrip}}(X, Y)$ with the structure of an adequate triple, such that the evaluation map $\text{Fun}_{\text{AdTrip}}(X, Y) \times X \rightarrow Y$ exhibits it as the internal mapping object in AdTrip . In particular, AdTrip is cartesian closed.

Consequently, one obtains a natural equivalence of adequate triples

$$\text{Fun}_{\text{AdTrip}}(X \times Y, Z) \simeq \text{Fun}_{\text{AdTrip}}(X, \text{Fun}_{\text{AdTrip}}(Y, Z)).$$

Proof. The pointwise pullback P of an ingressive and an egressive natural transformation $F \Rightarrow H \leftarrow G$ exists by assumption on Y . To verify that P is indeed a map of adequate triples, note that for an ingressive $x \rightarrow x'$, the map $P(x) \rightarrow P(x')$ participates in the commutative cube

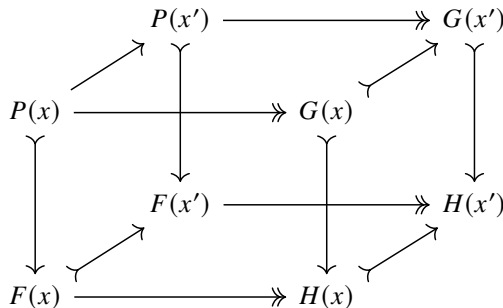

whose front and back face are cartesian by definition of P and whose bottom face is cartesian since $F \Rightarrow H$ is egressive. Consequently, also the top face is cartesian showing that $P(x) \rightarrow P(x')$ is also ingressive. The argument for the preservation of egressives is the same, and that P preserves ambigressives pullbacks follows directly from the pasting laws.

It is also obvious that the maps $P \rightarrow G$ and $P \rightarrow F$ are pointwise egressive and ingressive, respectively, and the argument above also verifies the second condition in the definition of an egressive transformation, and the argument is dual for the ingressives. In total, this shows that $\text{Fun}_{\text{AdTrip}}(X, Y)$ is an adequate triple.

To verify the universal property, let Z be a third adequate triple. It suffices to verify that under the equivalence $\text{Hom}_{\text{Cat}}(Z \times X, Y) \simeq \text{Hom}_{\text{Cat}}(Z, \text{Fun}(X, Y))$, a functor $F: Z \times X \rightarrow Y$ is a map of adequate triples if and only if the corresponding map $F': Z \rightarrow \text{Fun}(X, Y)$ takes values in $\text{Fun}_{\text{AdTrip}}(X, Y)$ and

determines a map of adequate triples. To see this, note that any ambigressive square in $Z \times X$ is uniquely a composite of four types of squares:

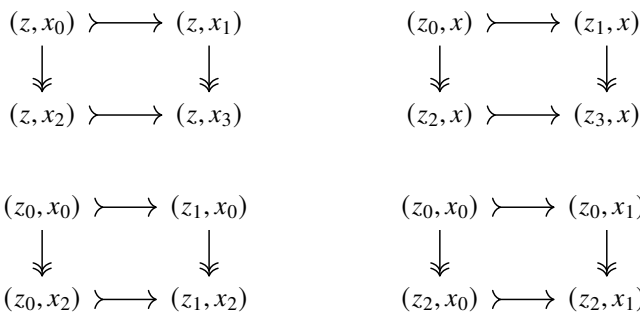

Now, F preserving ambigressive (cartesian) squares of the first type is equivalent to F' taking values in $\text{Fun}_{\text{AdTrip}}(X, Y)$. Preserving the ambigressive (automatically cartesian) squares as in the lower row then corresponds precisely to $F': Z \rightarrow \text{Fun}_{\text{AdTrip}}(X, Y)$ preserving ingressive and egressive morphisms. Finally, F preserves the cartesian ambigressive squares as in the upper right corner if and only if F' preserves ambigressive pullbacks. \square

One can generate more interesting examples of adequate triples using the following criterion:

Proposition 2.6. *Let $p: Y \rightarrow X$ be a functor and let $(X, X_{\text{in}}, X^{\text{eg}})$ be an adequate triple such that Y has all p -cartesian lifts over X_{in} . Then Y is part of an adequate triple $(Y, Y^\dagger, p^{-1}(X^{\text{eg}}))$, where a map is ingressive if it is p -cartesian and its image is ingressive in X , and egressive if its image under p is. This structure also upgrades p to a map of adequate triples.*

Proof. Consider the left solid cospan in the diagram

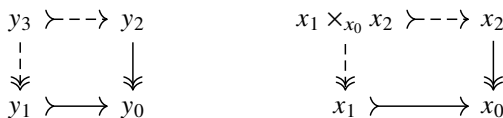

with $x_1 \rightarrow x_0 \leftarrow x_2$ its image in X under p . By assumption, the right diagram can be completed to an ambigressive pullback in X , and we let $y_3 \rightarrow y_2$ be a p -cartesian lift of $x_1 \times_{x_0} x_2 \rightarrow x_2$. The universal property of p -cartesian maps then implies that there exists a unique map $y_3 \rightarrow y_1$ which lives over $x_1 \times_{x_0} x_2 \rightarrow x_1$ and makes the left square commute. Note that the left square is ambigressive by definition. To see that it is also a pullback, compute

$$\begin{aligned}
 & \text{Hom}_Y(y, y_1) \times_{\text{Hom}_Y(y, y_0)} \text{Hom}_Y(y, y_2) \\
 & \simeq \text{Hom}_X(p(y), x_1) \times_{\text{Hom}_X(p(y), x_0)} \text{Hom}_Y(y, y_0) \times_{\text{Hom}_Y(y, y_0)} \text{Hom}_Y(y, y_2) \\
 & \simeq \text{Hom}_X(p(y), x_1) \times_{\text{Hom}_X(p(y), x_0)} \text{Hom}_Y(p(y), x_2) \times_{\text{Hom}_X(p(y), x_2)} \text{Hom}_Y(y, y_2) \\
 & \simeq \text{Hom}_X(p(y), x_1 \times_{x_0} x_2) \times_{\text{Hom}_X(p(y), x_2)} \text{Hom}_Y(y, y_2) \\
 & \simeq \text{Hom}_Y(y, y_3)
 \end{aligned}$$

for $y \in Y$, where the first equivalence uses the universal property of the cartesian edge $y_1 \rightarrow y_0$ and the last one that of $y_3 \rightarrow y_2$. Finally, note that the uniqueness of pullbacks implies that every ambigressive pullback is of this form and is thus clearly preserved by p , which is thus a map of adequate triples. \square

The case of Proposition 2.6 where p is a cartesian fibration admits the following generalisation:

Proposition 2.7. *Let $(X, X_{\text{in}}, X^{\text{eg}})$ be an adequate triple, $F: X^{\text{op}} \rightarrow \text{AdTrip}$ a functor and $p: Y \rightarrow X$ its cartesian unstraightening. Then Y has the structure of an adequate triple, in which a map $y_1 \rightarrow y_0$ is*

egressive if it factors as an egressive morphism in the fibre $Y_{p(y_1)} \simeq F(p(y_1))$, followed by a p -cartesian morphism with egressive image in X (and likewise for the ingressesives). Furthermore, this structure makes p a map of adequate triples.

An equivalent description of the egressives is given by unstraightening the functor $X^{\text{op}} \rightarrow \text{AdTrip} \xrightarrow{(-)^{\text{eg}}} \text{Cat}$ and then restricting the arising cartesian fibration to X^{eg} , and likewise for the ingressesives; this follows immediately from the fact that every map in the domain of a cartesian fibration factors uniquely as a fibrewise followed by a cartesian arrow.

Proof. Consider a cospan $f: y_1 \rightarrow y_0 \leftarrow y_2 : g$ where the left arrow is ingressive and the right arrow is egressive in Y . To show that this admits an ambigressive pullback, note that f decomposes into two egressive maps in Y , one contained in a fibre of p and the other p -cartesian (and likewise for $y_2 \rightarrow y_0$). By the pasting lemma for pullbacks, it therefore suffices to show the existence of an ambigressive pullback in the arising special cases.

First, suppose that both f and g are contained in a single fibre $Y_x \simeq F(x)$. Since the fibre forms an adequate triple, there exists an ambigressive pullback of f and g within Y_x . This square remains a pullback square in Y by [Lu09a, Proposition 4.3.1.10] and stays ambigressive by definition.

Next, suppose that g is a p -cartesian lift of an egressive arrow. Then Proposition 2.6 implies the existence of a pullback

$$\begin{array}{ccc}
 y_3 & \dashrightarrow & y_2 \\
 \downarrow & & \downarrow g \\
 y_1 & \xrightarrow{f} & y_0
 \end{array}$$

that maps to an ambigressive pullback in X . It also implies that the left vertical arrow is again p -cartesian and that the upper horizontal one is p -cartesian or fibrewise if f is (the former by switching the roles of ingressesives and egressives in 2.6). In both cases, it follows that the square is ambigressive.

The final case (i.e., if f is assumed a p -cartesian lift of an ingressive arrow) follows in the same fashion by again reversing the roles of the egressives and ingressesives in Proposition 2.6. \square

Example 2.8. Let $(X, X_{\text{in}}, X^{\text{eg}})$ be an adequate triple and let $\text{Tw}^r(X)$ be its twisted arrow ∞ -category, with the convention that the source and target define a right fibration. In particular, $s: \text{Tw}^r(X) \rightarrow X$ is a cartesian fibration and Proposition 2.6 endows $\text{Tw}^r(X)$ with the structure of an adequate triple, in which a map $\alpha \rightarrow \beta$ given by

$$\begin{array}{ccc}
 x & \xrightarrow{f} & y \\
 \alpha \downarrow & & \downarrow \beta \\
 w & \xleftarrow{g} & z
 \end{array}$$

is egressive if f is egressive, and ingressive if f is ingressive and g is an equivalence.

Example 2.9. Let A be an ∞ -category, considered as an adequate triple $(A, A, \iota A)$ with all morphisms ingressive and only the equivalences egressive. Example 2.8 endows $\text{Tw}^r(A)$ with the structure of an adequate triple, where a morphism is ingressive if its image under $t: \text{Tw}^r(A) \rightarrow A^{\text{op}}$ is an equivalence, and egressive if its image under $s: \text{Tw}^r(A) \rightarrow A$ is an equivalence. This determines a functor $\text{Tw}^r: \text{Cat} \rightarrow \text{AdTrip}$.

For the construction of span ∞ -categories, this structure will be of particular interest when A is a simplex. For example, $\text{Tw}^r([2])$ is the poset

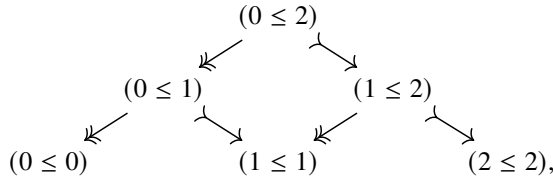

where the left-pointing arrows are egressive and the right-pointing ones are ingressive. More generally, the ambigressive pullbacks in $\text{Tw}^r([n])$ are precisely given by the diagrams

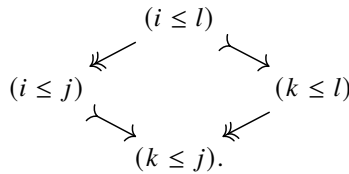

for $i \leq k \leq j \leq l$.

We next set out to construct Barwick’s functor

$$\text{Span} : \text{AdTrip} \rightarrow \text{Cat},$$

sending each adequate triple to its ∞ -category of spans, described informally in the introduction. We will define Span more precisely as a functor into complete Segal ∞ -groupoids. Recall that such functors can be obtained from the following general procedure:

Construction 2.10. Given a functor $C : D \rightarrow A$ between ∞ -categories, we obtain a ‘singular complex’ functor $S_C : A \rightarrow \mathcal{P}(D)$ with $\mathcal{P}(D) = \text{Fun}(D^{\text{op}}, \text{Gpd})$ by currying the composition

$$D^{\text{op}} \times A \xrightarrow{C^{\text{op}} \times \text{id}} A^{\text{op}} \times A \xrightarrow{\text{Hom}_A} \text{Gpd};$$

that is, $S_C(X)_d = \text{Hom}_A(C(d), X)$. If A is cocomplete, then S_C is right adjoint to the colimit extension $|-|_C : \mathcal{P}(D) \rightarrow A$; see [Lu09a, Proposition 5.2.6.3].

For the cosimplicial object $\Delta \rightarrow \text{Cat}, n \mapsto [n]$, we obtain in this fashion an adjunction

$$\text{ac} : \text{sGpd} \rightleftarrows \text{Cat} : \mathbf{N},$$

where $\text{sGpd} = \mathcal{P}(\Delta)$ is the ∞ -category of simplicial ∞ -groupoids. By results of Joyal, Lurie, Rezk and Tierney [JT07, Lu09b, Re01], the *nerve* functor \mathbf{N} is fully faithful with essential image the full subcategory of complete Segal objects inside sGpd – that is, those simplicial ∞ -groupoids T that satisfy the Segal condition and for which the diagram

$$\begin{array}{ccc}
 T_0 & \xrightarrow{\Delta} & T_0 \times T_0 \\
 s \downarrow & & \downarrow (s,s) \\
 T_3 & \xrightarrow{(d_{\{0,2\}}, d_{\{1,3\}})} & T_1 \times T_1
 \end{array}$$

is cartesian; see [Re10, Section 10] for this characterisation of completeness. A general cosimplicial object C in A therefore gives rise to a functor $A \rightarrow \text{Cat}$ via the composition of S_C with ac . When S_C takes values in (complete) Segal ∞ -groupoids, we have a good understanding of this functor, since

there is then no need to localise; this happens precisely when the cosimplicial object C satisfies the dual version of the Segal and completeness conditions.

Example 2.11. Consider the functor $S_B : \text{Cat} \rightarrow \text{sGpd}$ associated to the cosimplicial object

$$B : \Delta \rightarrow \text{Cat}, \quad [n] \mapsto [n] \star [n]^{\text{op}}.$$

Then $S_B(C) \simeq \text{NTw}^r(C)$. This follows from the observation that Tw^r arises from a right Quillen functor between the Joyal model structures whose left adjoint sends $[n]$ to $[n] \star [n]^{\text{op}}$ (see [Lu17, Section 5.2.1] or [HNP17, Proposition 4.13]). In particular, S_B takes values in complete Segal ∞ -groupoids.

Applying this construction to the functor $\text{Tw}^r : \Delta \rightarrow \text{AdTrip}$ sending each simplex $[n]$ to $\text{Tw}^r([n])$ with the structure from Example 2.9, we obtain the following:

Definition 2.12. We define $\text{Span} : \text{AdTrip} \rightarrow \text{Cat}$ as the composition

$$\text{AdTrip} \xrightarrow{S_{\text{Tw}^r}} \text{sGpd} \xrightarrow{\text{ac}} \text{Cat}.$$

Theorem 2.13 (Barwick). *The essential image of S_{Tw^r} is contained in the complete Segal ∞ -groupoids. In other words, there is a natural equivalence*

$$\text{Hom}_{\text{Cat}}([n], \text{Span}(X)) \simeq \text{Hom}_{\text{AdTrip}}(\text{Tw}^r([n]), X).$$

We will give a new proof of this result (avoiding Barwick’s recourse to a point-set model). Recall also that the category associated to a complete Segal ∞ -groupoid T can be described rather explicitly. For example, the core of $\text{ac}(T)$ is simply given by T_0 , and its morphism ∞ -groupoids are given by the fibres of $(d_1, d_0) : T_1 \rightarrow T_0^2$. In the case at hand, this gives us the desired description of $\text{Span}(X, X_{\text{in}}, X^{\text{eg}})$: objects are objects of X , morphisms from x to y are spans

$$x \leftarrow z \rightarrow y$$

with the left arrow egressive and the right arrow ingressive, and composition proceeds by pullback of spans. Completeness furthermore implies that $\iota \text{Span}(X, X_{\text{in}}, X^{\text{eg}}) \simeq \iota(X)$ via the degenerate spans consisting of identities. Before we dive into the proof, let us record two immediate properties of the construction, the second of which in particular yields inclusions of subcategories

$$(X^{\text{eg}})^{\text{op}} \longrightarrow \text{Span}(X) \longleftarrow X_{\text{in}},$$

when applied to

$$(X, \iota X, X^{\text{eg}}) \longrightarrow X \longleftarrow (X, X_{\text{in}}, \iota X).$$

Lemma 2.14. *For an adequate triple $(X, X_{\text{in}}, X^{\text{eg}})$ with reverse $X^{\text{rev}} = (X, X^{\text{eg}}, X_{\text{in}})$ as in Example 2.3, there is a natural canonical equivalence*

$$\text{Span}(X)^{\text{op}} \simeq \text{Span}(X^{\text{rev}}).$$

Proof. For each $[n]$, consider $\text{Tw}^r([n])$ and $\text{Tw}^r([n]^{\text{op}})$ with the structure of an adequate triple as in Example 2.9. There is a natural equivalence of cosimplicial adequate triples $\text{Tw}^r([-]^{\text{op}}) \simeq \text{Tw}^r([-]^{\text{rev}})$, sending an object $(i \geq j)$ in $\text{Tw}^r([n]^{\text{op}})$ to the object $(j \leq i)$ in $\text{Tw}^r([n])$. This induces a natural equivalence of simplicial objects

$$\text{Hom}_{\text{AdTrip}}(\text{Tw}^r([-]^{\text{op}}), X) \simeq \text{Hom}_{\text{AdTrip}}(\text{Tw}^r([-]^{\text{rev}}), X) \simeq \text{Hom}_{\text{AdTrip}}(\text{Tw}^r([-]), X^{\text{rev}})$$

so that the simplicial ∞ -groupoid defining $\text{Span}(X)$ is the reverse of that defining $\text{Span}(X^{\text{rev}})$. The result follows since generally $\text{ac}(T)^{\text{op}} \simeq \text{ac}(T^{\text{rev}})$ as this is true on simplices. \square

Proposition 2.15. *Let $A \subseteq B$ be a subcategory. Then the triples (B, A, ι_B) and (B, ι_B, A) are adequate and*

$$\text{Span}(B, A, \iota_B) \simeq A \quad \text{and} \quad \text{Span}(B, \iota_B, A) \simeq A^{\text{op}}.$$

Proof. We shall prove the first claim; the second then follows from 2.14. The triple (B, A, ι_B) is evidently adequate (cf. Example 2.3). Note that the ∞ -groupoid of functors from an adequate triple $(X, X_{\text{in}}, X^{\text{eg}})$ into (B, A, ι_B) is equivalent to the ∞ -groupoid of functors $X \rightarrow B$ which invert the edges in X^{eg} and take those of X_{in} into A . Applying this to $X = \text{Tw}^r([n])$ shows that the remaining claim is equivalent to the assertion that the source map

$$s: \text{Tw}^r([n]) \longrightarrow [n]$$

is a localisation (necessarily at those maps whose source component is an equivalence). This is, in fact, true for all ∞ -categories C in place of $[n]$, for example, since $\text{Tw}^r(C) \rightarrow C$ is a cocartesian fibration with contractible fibres (which are always localisations; see Lemma 5.5 below). The localisation property is, however, particularly easy to see when C admits a terminal object. In that case, the source evaluation $\text{Tw}^r(C) \rightarrow C$ is even a Bousfield localisation, with fully faithful left adjoint sending $c \mapsto (c \rightarrow *)$. \square

We now turn to the proof of Theorem 2.13. Instead of following Barwick’s strategy of explicitly filling simplices in a point-set implementation of the above construction, our proof will be a simple adaptation of the argument given in [CDH+20, Section 2.1] for the case of stable ∞ -categories (with all maps ingressive and egressive). In fact, we will prove a slightly stronger statement, which will ultimately allow us to deduce Theorem A. It uses the following definition:

Definition 2.16. Let A be an ∞ -category and X an adequate triple. We write $Q_A(X)$ for the ∞ -category $\text{Fun}_{\text{AdTrip}}(\text{Tw}^r(A), X)$, where $\text{Tw}^r(A)$ is the adequate triple from Example 2.9 and denote by $Q: \text{Cat}^{\text{op}} \times \text{AdTrip} \longrightarrow \text{AdTrip}$ the resulting functor.

In particular, each adequate triple X gives rise to a natural simplicial diagram $Q_{\bullet}(X)$ in Cat .

Lemma 2.17. *Let X be an adequate triple. Then the simplicial ∞ -category $Q_{\bullet}(X)$ satisfies the Segal and completeness conditions; that is, the Segal maps*

$$Q_n(X) \longrightarrow Q_1(X) \times_{Q_0(X)} Q_1(X) \cdots \times_{Q_0(X)} Q_1(X)$$

are equivalences and

$$\begin{array}{ccc} Q_0(X) & \xrightarrow{\Delta} & Q_0(X) \times Q_0(X) \\ s \downarrow & & \downarrow (s,s) \\ Q_3(X) & \xrightarrow{(d_{(0,2)}, d_{(1,3)})} & Q_1(X) \times Q_1(X) \end{array}$$

is cartesian.

Note that this immediately implies Theorem 2.13, as $\iota: \text{Cat} \rightarrow \text{Gpd}$ preserves limits.

Proof. Let $\mathcal{J}_n \subseteq \text{Tw}^r([n])$ denote the subposet consisting of those $(i \leq j)$ with $j \leq i + 1$ (i.e., the zig-zag along the bottom). Note that \mathcal{J}_n decomposes as an iterated pushout

$$\mathcal{J}_n \simeq \text{Tw}^r([1]) \cup_{\text{Tw}^r([0])} \text{Tw}^r([1]) \cup \cdots \cup_{\text{Tw}^r([0])} \text{Tw}^r([1])$$

along the Segal maps; in fact, the nerve $N(\mathcal{J}_n)$ is already the iterated pushout of the nerves $N(\text{Tw}^r([1]))$ in simplicial ∞ -groupoids (see [Ha18, Proposition 5.13] for a similar argument). The iterated pullback

appearing in the Segal condition is therefore equivalent to the full subcategory $J_n(X)$ of $\text{Fun}(\mathcal{J}_n, X)$ spanned by those functors taking left-pointing edges in \mathcal{J}_n (i.e., those of the form $(i \leq i + 1) \rightarrow (i \leq i)$) to ingressesives and right-pointing arrows, namely, $(i \leq i + 1) \rightarrow (i + 1 \leq i + 1)$, to egressives. Furthermore, this translates the Segal map to the map $Q_n(X) \rightarrow J_n(X)$ induced by the restriction

$$\text{Fun}(\text{Tw}^r([n]), X) \longrightarrow \text{Fun}(\mathcal{J}_n, X).$$

But from the pointwise formula for Kan extensions, one finds that a diagram $F : \text{Tw}^r([n]) \rightarrow X$ lies in $Q_n(X)$ if and only if it is right Kan extended from its restriction to \mathcal{J}_n , which has to lie in J_n . The claim now follows from [Lu09a, Proposition 4.3.2.15], since right Kan extension from a full subcategory is fully faithful.

Similarly, for completeness, we first note that the map $P \rightarrow Q_3(X)$ from the pullback in question to the lower left corner is fully faithful since the degeneracy $Q_0(X)^2 \rightarrow Q_1(X)^2$ is (as $|\text{Tw}^r([1])| \simeq *$). We claim that its essential image consists exactly of those diagrams whose edges are all equivalences; since also $|\text{Tw}^r([3])| \simeq *$ these are precisely the constant ones, which gives the result. So consider a diagram

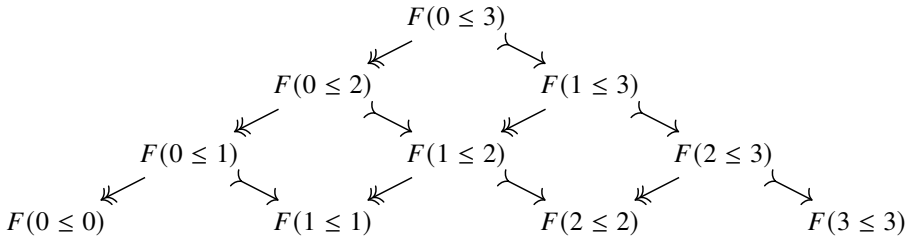

all of whose squares are (ambigressive) cartesian and such that the four compositions

$$F(0 \leq 2) \longrightarrow F(0 \leq 0), \quad F(0 \leq 2) \longrightarrow F(2 \leq 2)$$

$$F(1 \leq 3) \longrightarrow F(1 \leq 1), \quad F(1 \leq 3) \longrightarrow F(3 \leq 3)$$

are equivalences. Then it first follows that, as pullbacks of equivalences, also $F(0 \leq 3) \rightarrow F(0 \leq 1)$ and $F(0 \leq 3) \rightarrow F(2 \leq 3)$ are equivalences and then by two-out-of-six, the entire outer slopes are. But then by commutativity of the larger rectangles, also $F(0 \leq 1) \rightarrow F(1 \leq 1)$ and $F(2 \leq 3) \rightarrow F(2 \leq 2)$ are equivalences, and then as pullbacks thereof also $F(0 \leq 2) \rightarrow F(1 \leq 2)$ and $F(1 \leq 3) \rightarrow F(1 \leq 2)$. Finally, this implies that also $F(1 \leq 2) \rightarrow F(1 \leq 1)$ and $F(1 \leq 2) \rightarrow F(2 \leq 2)$ are equivalences by two-out-of-three. \square

Next we shall describe functors into span ∞ -categories. More precisely, we will show that the equivalence between functors $[n] \rightarrow \text{Span}(X)$ and maps of adequate triples $\text{Tw}^r([n]) \rightarrow X$ from Theorem 2.13 extends to all ∞ -categories:

Theorem 2.18. *The functors $\text{Tw}^r : \text{Cat} \rightleftarrows \text{AdTrip} : \text{Span}$ form an adjoint pair. In other words, for each ∞ -category A and each adequate triple X , there is a natural equivalence*

$$\text{Hom}_{\text{AdTrip}}(\text{Tw}^r(A), X) \simeq \text{Hom}_{\text{Cat}}(A, \text{Span}(X)),$$

where $\text{Tw}^r(A)$ is as in Example 2.9.

Remark 2.19. Using a different argument, this result was first sketched by Raskin in [Ra14, Chapter 20]. The resulting description of functors into span categories is, for example, also used in [HS21] to perform parametrised surgery on the cobordism ∞ -categories $\text{Cob}(C, \mathcal{Q})$ from [CDH+20], which are hermitian refinements of $\text{Span}(C)$.

Recall from Definition 2.16 that we abbreviate

$$Q_A(X) = \text{Fun}_{\text{AdTrip}}(\text{Tw}^r(A), X).$$

The theorem will follow readily from the following:

Proposition 2.20. *For each adequate triple X , the functor $Q_-(X) : \text{Cat}^{\text{op}} \rightarrow \text{Cat}$ preserves limits.*

We will employ the (opposite of the) following criterion:

Lemma 2.21. *Let $f : D \rightarrow E$ be a functor from a small to a cocomplete category, such that the right adjoint in the induced adjunction*

$$|-|_f : \mathcal{P}(D) \rightleftarrows :S_f$$

is fully faithful. Then for a functor $F : E \rightarrow C$ to another cocomplete category, the following are equivalent:

- (1) *F preserves colimits,*
- (2) *the natural map $|-|_{F \circ f} \implies F \circ |-|_f$ is an equivalence, and*
- (3) (i) *the natural map $f_!(F \circ f) \implies F$ is an equivalence (i.e., F is left Kan extended from its restriction along f), and*
 (ii) *$|-|_{F \circ f} : \mathcal{P}(D) \rightarrow C$ inverts all maps that $|-|_f$ inverts.*

Applying this to $\Delta \subset \text{Cat}$ and taking opposites in particular shows that a functor $F : \text{Cat}^{\text{op}} \rightarrow C$ preserves limits if and only if it is right Kan extended from its restriction along $\Delta^{\text{op}} \subset \text{Cat}^{\text{op}}$ and the restriction $F : \Delta^{\text{op}} \rightarrow C$ is a complete Segal object in C . The maps

$$\Delta^{\{0,1\}} \cup_{\Delta^{\{1\}}} \dots \cup_{\Delta^{\{n-1\}}} \Delta^{\{n-1,n\}} \longrightarrow \Delta^n \quad \text{and} \quad \Delta^3 / \Delta^{\{0,2\}}, \Delta^{\{1,3\}} \longrightarrow \Delta^0$$

encoding the Segal and completeness conditions are (by design) categorical equivalences (i.e., inverted by $\text{ac} : \text{sGpd} \rightarrow \text{Cat}$), proving that if $|-|_{F \circ f} : \text{sGpd} \rightarrow C^{\text{op}}$ inverts these, then $F : \Delta^{\text{op}} \rightarrow C$ is a complete Segal object, and the Yoneda lemma reduces the converse to the case $C = \text{Gpd}$, where it follows from the fact that $|-|_{(\text{NC})^{\text{op}}} \simeq \text{Hom}_{\text{Cat}}(\text{ac}(-), C)$ as (colimit preserving) functors $\text{sGpd} \rightarrow \text{Gpd}^{\text{op}}$.

Proof. Let us point out that any colimiting cocone $G : I^{\triangleright} \rightarrow E$ arises as the image of a colimiting cocone $G' : I^{\triangleright} \rightarrow \mathcal{P}(D)$ under $|-|_f$: indeed, one can take G' to be the colimit of the diagram $S_f \circ G|_I : I \rightarrow \mathcal{P}(D)$. Consequently, a functor out of E preserves colimits if and only if its composition with $|-|_f$ does. Using this, (1) \Leftrightarrow (2) is an immediate consequence of [Lu09a, Lemma 5.1.5.5].

For (2) \Rightarrow (3), (ii) follows immediately. To see (i), note that F agrees with the left Kan extension of $|-|_{F \circ f} = F \circ |-|_f$ along $|-|_f$, since $|-|_f$ is a localisation [Lu09a, Proposition 5.2.7.12]. In turn, $|-|_{F \circ f}$ is the left Kan extension of $F \circ f$ along the Yoneda embedding $h : D \rightarrow \mathcal{P}(D)$ [Lu09a, Lemma 5.1.5.5]. The claim then follows from transitivity of Kan extensions.

Finally, for (3) \Rightarrow (2), note that (ii) implies that $|-|_{F \circ f}$ descends along $|-|_f$ to some functor $G : E \rightarrow C$, which is then automatically its left Kan extension along $|-|_f$. Part (i) and transitivity of Kan extensions then imply that $G \simeq F$, or in other words, that $|-|_{F \circ f} \simeq F \circ |-|_f$ as desired. \square

Proof of Proposition 2.20. Since $Q(X)$ is a complete Segal object in Cat by Lemma 2.17, we have already shown Item (ii) of Lemma 2.21(3). So we need only show that $Q(X) : \text{Cat}^{\text{op}} \rightarrow \text{Cat}$ is right Kan extended from its restriction to Δ^{op} . By the pointwise formula for Kan extensions, this means that the tautological map

$$Q_D(X) \longrightarrow \lim_{n \in (\Delta/D)^{\text{op}}} Q_n(X)$$

is an equivalence for all $D \in \text{Cat}$. The diagram $\Delta/D \rightarrow \Delta \hookrightarrow \text{Cat}$, giving rise to the right-hand side has colimit D and is a typical example of a functor $F : I \rightarrow \text{Cat}$ such that the natural map

$$\text{colim}_{i \in I} N(F_i) \longrightarrow N(\text{colim}_{i \in I} F_i) \tag{*}$$

is an equivalence (with both sides evaluating to ND). We will directly show that $Q_{(-)}(X)$ preserves all limits over diagrams with this property.

To this end, note that there are natural equivalences of simplicial ∞ -groupoids

$$N(\text{Tw}^r(C)) \simeq [i \mapsto \text{Hom}_{\text{Cat}}([i] \star [i]^{\text{op}}, C)] \simeq [i \mapsto \text{Hom}_{\text{sGpd}}(\Delta^i \star (\Delta^i)^{\text{op}}, N(C))].$$

In particular, since $\Delta^i \star (\Delta^i)^{\text{op}} \simeq \Delta^{2i+1}$ is completely compact in sGpd , we find an equivalence

$$\text{colim}_{i \in I} \text{Tw}^r(F_i) \xrightarrow{\sim} \text{Tw}^r(\text{colim}_{i \in I} F_i)$$

because of (*); let us warn the reader that the above map need not be an equivalence without any assumption on F , as the diagram $[1] \xleftarrow{0} [0] \xrightarrow{1} [1]$ with pushout $[2]$ shows. In the case at hand, it follows that the map

$$\text{Fun}(\text{Tw}^r(\text{colim}_{i \in I} F_i), X) \longrightarrow \lim_{i \in I} \text{Fun}(\text{Tw}^r(F_i), X)$$

is an equivalence.

We have to show that this restricts to an equivalence between the full subcategory $Q_{\text{colim}_i F_i}(X)$ on the left (spanned by morphisms of adequate triples) and $\lim_{i \in I} Q_{F_i}(X)$ on the right. To this end, notice that any ambigressive pullback square in $\text{Tw}^r(A)$, say

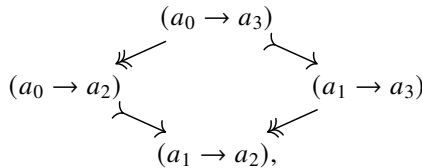

is contained (up to equivalence) in $\text{Tw}^r([3])$ for a map $[3] \rightarrow A$, namely, that given by the string $a_0 \rightarrow a_1 \rightarrow a_2 \rightarrow a_3$. Consequently, a functor $\text{Tw}^r(A) \rightarrow X$ is a morphism of adequate triples if and only if each restriction

$$\text{Tw}^r([3]) \longrightarrow \text{Tw}^r(A) \longrightarrow X$$

is such. To apply this, note that one has

$$\text{Hom}_{\text{Cat}}([3], \text{colim}_{i \in I} F_i) \simeq N_3(\text{colim}_{i \in I} F_i) \simeq \text{colim}_{i \in I} N_3(F_i) \simeq \text{colim}_{i \in I} \text{Hom}_{\text{Cat}}([3], F_i)$$

whenever F satisfies (*), so that a functor $\text{Tw}^r(\text{colim}_i F_i) \rightarrow X$ lies in $Q_{\text{colim}_i F_i}(X)$ if and only if for every $j \in I$ and map $[3] \rightarrow F_j$, the composite

$$\text{Tw}^r([3]) \longrightarrow \text{Tw}^r(F_j) \longrightarrow \text{Tw}^r(\text{colim}_i F_i) \longrightarrow X$$

lies in $Q_3(X)$. But this is the case if and only if the functor restricts to an element of $Q_{F_j}(X)$ for every $j \in I$ and thus by definition if and only if it defines an element of $\lim_i Q_{F_i}(X)$, as desired. \square

Proof of Theorem 2.18. By Proposition 2.20, $\iota Q(X) \simeq \text{Hom}_{\text{AdTrip}}(\text{Tw}^r(-), X) : \text{Cat}^{\text{op}} \rightarrow \text{Gpd}$ preserves limits as does $\text{Hom}_{\text{Cat}}(-, \text{Span}(X))$, so by Lemma 2.21, they are both right Kan extended from $\Delta^{\text{op}} \subset \text{Cat}^{\text{op}}$. Thus, they agree if their restrictions to Δ^{op} agree, which is the case by Theorem 2.13. \square

In fact, one can upgrade Theorem 2.18 to describe the full functor ∞ -category $\text{Fun}(K, \text{Span}(X))$:

Corollary 2.22. *There is a canonical equivalence*

$$\text{Fun}(A, \text{Span}(X)) \simeq \text{Span}(Q_A(X)),$$

natural in $A \in \text{Cat}$ and $X \in \text{AdTrip}$.

We warn the reader that this result is misstated as $\text{Fun}(A, \text{Span}(X)) \simeq Q_A(X)$ in [Ra14, Section 20.9], which is only true on groupoid cores.

Proof. The left adjoint $\text{Tw}^r : \text{Cat} \rightarrow \text{AdTrip}$ preserves the cartesian product. By adjunction, the right adjoint $\text{Span} : \text{AdTrip} \rightarrow \text{Cat}$ then sends the internal mapping object $Q_A(X) = \text{Fun}_{\text{AdTrip}}(\text{Tw}^r(A), X)$ from Lemma 2.5 to the internal mapping object $\text{Fun}(A, \text{Span}(X))$ in Cat . \square

Example 2.23. Since the functors $s : \text{Tw}^r(A) \rightarrow A$ and $t : \text{Tw}^r(A) \rightarrow A^{\text{op}}$ are localisations, it follows easily from the formula of Corollary 2.22 that the functors

$$\text{Fun}(A, X^{\text{in}}) \longrightarrow \text{Fun}(A, \text{Span}(X)) \quad \text{and} \quad \text{Fun}(A^{\text{op}}, X^{\text{eg}})^{\text{op}} \longrightarrow \text{Fun}(A, \text{Span}(X))$$

are inclusions of (non-full) subcategories for all $A \in \text{Cat}$. Alternatively, this statement can also be reduced to the case $A = [0]$ (which we recorded before Lemma 2.14) by means of Lemma A.4.

In a different direction, note that even if X admits pullbacks and carries the trivial structure of an adequate triple with all maps ingressive and egressive, the same is typically not true for $Q_A(X) = \text{Fun}_{\text{AdTrip}}(\text{Tw}^r(A), X)$; this phenomenon is the basis for the notions of forwards and backwards surgery in [HS21].

3. Cartesian fibrations and ∞ -categories of spans

The goal of this section is to describe the cocartesian fibration associated to the functor $\text{Span} : \text{AdTrip} \rightarrow \text{Cat}$, which is itself given by a certain span ∞ -category of adequate triples. As a direct application, we will obtain a new and fairly direct proof of the main result of [BGN18], which identifies the dual cartesian fibration of a cocartesian fibration in terms of a span construction. We shall more generally analyse the interaction of span categories and (co)cartesian fibrations in Section 5 below.

To understand (co)cartesian edges in span ∞ -categories, we start by reproducing a criterion due to Barwick. In fact, we provide a proof different from [Ba17] and inspired by the proof of the additivity theorem for Grothendieck–Witt theory in [CDH+20, Section 2.6]; see Example 3.3 for the details of this connection.

Theorem 3.1 (Barwick). *Let $p : Y \rightarrow X$ be a morphism in AdTrip and let f be an edge in X_{in} such that the following conditions hold:*

- (1) *Every pullback of f along an egressive edge has a lift in Y_{in} which is simultaneously p -cocartesian and p_{in} -cocartesian, for any choice of lift of its source.*
- (2) *Consider any commutative square σ in Y*

$$\begin{array}{ccc} w & \xrightarrow{g'} & v \\ g \downarrow & & \downarrow \\ u & \xrightarrow{\psi} & y \end{array}$$

such that $p(\sigma)$ is an ambigressive pullback in X , the edge g' is ingressive, the morphism g is egressive, and the morphism ψ is a p -cocartesian and ingressive lift of f . Then g' is p -cocartesian if and only if the square is an ambigressive pullback.

Then an edge $x \rightarrow y$ of $\text{Span}(Y)$, represented by a span

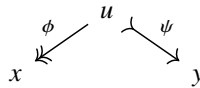

such that ψ covers f , is $\text{Span}(p)$ -cocartesian if ϕ is p^{eg} -cartesian and ψ is p -cocartesian as indicated.

Proof. Unwinding definitions, we have to show that for any span $x \leftarrow w \rightarrow z$ in Y , the solid diagram (ignoring the numbers for a moment)

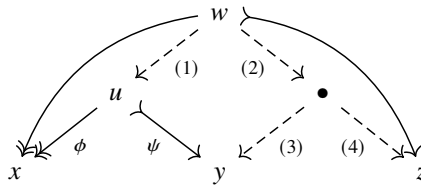

admits an essentially unique dashed filling lying over a given entirely solid diagram in $\text{Span}(X)$, such that all left-pointing arrows are egressive and all right-pointing arrows ingressive, and the top square is cartesian. We then first observe that the second condition on f (the image of ψ in X) implies that for such square in which the arrows $w \rightarrow u$ and $w \rightarrow \bullet$ are egressive and ingressive, respectively the assertion that the square is cartesian and $\bullet \rightarrow y$ is egressive is equivalent to the assertion that the map $w \rightarrow \bullet$ is p -cocartesian, so we may instead show that there is a unique filler with this property.

We do so by filling the diagram step by step, as indicated by the numbers in the above diagram, essentially uniquely each time:

- (1) There exists a unique egressive filler because ϕ is p^{eg} -cartesian.
- (2) The first assumption on f provides a p -cocartesian left, that is automatically unique and also p_{in} -cocartesian and ingressive.
- (3) There exists a unique filler making the middle square commute because $w \rightarrow \bullet$ is p -cocartesian.
- (4) There is a unique ingressive filler because $w \rightarrow \bullet$ is p_{in} -cocartesian. □

In the special case where f is an equivalence, the two assumptions are automatic, so we obtain the following:

Corollary 3.2. *If $p: Y \rightarrow X$ is a morphism in AdTrip , then a span in Y of the form*

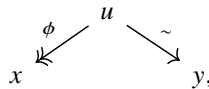

represents a $\text{Span}(p)$ -cocartesian morphism whenever ϕ is p^{eg} -cartesian.

Remark 3.3. We feel obliged to point out two oversights in the statement of the above result in [Ba17, 12.2 Theorem]:

- (i) Barwick requires that the edge ϕ be p -cartesian and not p^{eg} -cartesian. Our proof above hopefully makes it transparent why this is not enough. For an explicit counterexample, consider $X = Y = [1]^2$ with p the identity, where we equip the source with the triple structure with the horizontal maps (and the identities) ingressive and everything but the horizontal maps egressive and the target with the same ingressives but all maps egressive.
- (ii) As he is working at the point-set level, Barwick has to show that $\text{Span}(p)$ is an inner fibration. To this end, he assumes that p is an inner fibration, but in fact requires the stronger assumption that p is an isofibration, as can be seen by lifting a 2-simplex in $\text{Span}(Y)$ of the form

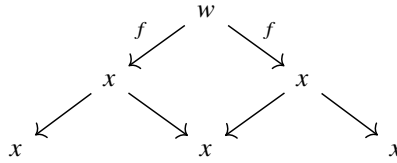

where f is some equivalence and all other maps identities.

In order to carry out iterated span constructions as in [BGN18] at the point-set level, one therefore needs to check that if p is an isofibration, then so is $\text{Span}(p)$. This is indeed the case as a direct consequence of equivalences in span ∞ -categories being precisely the spans of equivalences (which itself follows from the completeness assertion for $\iota\mathcal{Q}(X)$ in Lemma 2.17; see also [Ba17, Proposition 3.4]).

Example 3.4. In particular, in light of the previous remark, let us recount the original purpose of Theorem 3.1 in [Ba17], which is Barwick’s unfurling construction. The input is an adequate triple $(X, X_{\text{in}}, X^{\text{eg}})$ and a functor $F: X^{\text{op}} \rightarrow \text{Cat}$ such that

- (1) for every ingressive $f: x \rightarrow y$, the induced functor $f^*: F(y) \rightarrow F(x)$ admits a left adjoint $f_!$, and
- (2) the image under F of every ambigrressive pullback in X is left-adjointable; that is, given the left square in

$$\begin{array}{ccc}
 x & \xrightarrow{f} & y \\
 \downarrow g & & \downarrow h \\
 w & \xrightarrow{i} & z
 \end{array}
 \qquad
 \begin{array}{ccc}
 F(x) & \xrightarrow{f_!} & F(y) \\
 g^* \uparrow & & \uparrow h^* \\
 F(w) & \xrightarrow{i_!} & F(z),
 \end{array}$$

the right one commutes via the Beck-Chevalley transformation $f_! g^* \Rightarrow h^* i_!$.

The output is an extension of $F: (X^{\text{eg}})^{\text{op}} \rightarrow \text{Cat}$ to a functor $\text{Unf}(F): \text{Span}(X, X_{\text{in}}, X^{\text{eg}}) \rightarrow \text{Cat}$, the *unfurling* of F , whose additional functoriality is given by the left adjoints to the images of the ingressive edges in X .

It is constructed by considering the cartesian unstraightening $p: Y \rightarrow X$ of F , which carries the structure of an adequate triple with ingressives $p^{-1}(X_{\text{in}})$ and egressives Y^\dagger , the subcategory formed by the p -cartesian lifts of degrees in X^{eg} , by Proposition 2.6. The claim is that the induced map

$$\text{Span}(p): \text{Span}(Y, p^{-1}(X_{\text{in}}), p^\dagger) \longrightarrow \text{Span}(X, X_{\text{in}}, X^{\text{eg}})$$

is a cocartesian fibration and that its cocartesian straightening is the desired extension

$$\text{Unf}(F): \text{Span}(X, X_{\text{in}}, X^{\text{eg}}) \rightarrow \text{Cat}.$$

The first claim follows from an application of Theorem 3.1. Given a span

$$x \xleftarrow{g} y \xrightarrow{f} z$$

in X and an element $c \in F(x) \subseteq Y$, we can build a $\text{Span}(p)$ -cocartesian lift as follows. Per construction, we can first choose a p -cartesian edge $\phi: d \rightarrow c$ covering g . By the first assumption on F and the fibrational characterisation of adjunctions, the edge f then further admits a locally p -cocartesian lift $\psi: d \rightarrow e$, which is in fact p -cocartesian by [Lu09a, Corollary 5.2.2.4]. Note that this span in Y indeed defines a morphism $c \rightarrow e$ in $\text{Span}(Y, p^{-1}(X_{\text{in}}), p^\dagger)$. To see that it is $\text{Span}(p)$ -cocartesian, we check the conditions of Theorem 3.1. For the first condition, note that all egressive pullbacks of f admit p -cocartesian lifts by the same argument that gives the existence of ϕ , since such pullbacks are again ingressive. That these lifts are also p_{in} -cocartesian follows directly from the definition of the ingressives in Y . Next, a square in Y as in the second condition automatically has the form of the solid square

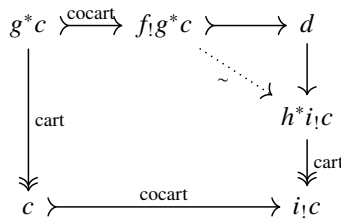

if it covers the ambigressive pullback

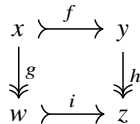

in X . The dotted map is the Beck-Chevalley transformation, which is an equivalence by the second assumption on F , and the upper right triangle commutes by a simple diagram chase. The task is to show that the large square is an ambigressive pullback if and only if the upper right horizontal map is an equivalence. But if the diagram is ambigressive, the map $d \rightarrow i_!c$ is by definition p -cartesian, which indeed forces the upper right-hand corner to consist of equivalences. And conversely, if the corner consists of equivalences, then the right-hand composition is cartesian, making the square ambigressive and also forcing it to be cartesian as it covers a cartesian base (see the proof of Proposition 2.6 above for the relevant calculation).

To apply (the corrected version of) Barwick’s criterion, we finally have to check that ϕ is p^{eg} -cartesian. But since it is p -cartesian, we are saved by the left-cancellation property of cartesian edges.

Finally, it remains to check that the composite

$$(X^{\text{eg}})^{\text{op}} \simeq \text{Span}(X, \iota X, X^{\text{eg}}) \longrightarrow \text{Span}(X, X_{\text{in}}, X^{\text{eg}}) \xrightarrow{\text{Unf}(F)} \text{Cat}$$

agrees with the restriction of F . Unwinding definitions, this composite is given as the cocartesian straightening of $\text{Span}(Y, p^{-1}(\iota X), Y^\dagger) \rightarrow \text{Span}(X, \iota X, X^{\text{eg}})$ and the statement that this is indeed the restriction of F is the main result of [BGN18], which we shall reprove momentarily in Corollary 3.18 below.

Example 3.5. Suppose that C is stable and consider the target projection $p = t: \text{Ar}(C) \rightarrow C$, regarded as a map of adequate triples with all maps both ingressive and egressive. One readily checks that every edge f in C satisfies the assumptions of Theorem 3.1. It follows that $\text{Span}(\text{Ar}(C)) \rightarrow \text{Span}(C)$ is a cocartesian fibration for every stable C , and thus by Lemma 2.14, also a cartesian fibration. Taking classifying ∞ -groupoids (i.e., classifying spaces) preserves pullback squares whose right edge is both a cocartesian and cartesian fibration, as can be shown from Quillen’s Theorem B (see [St21, St22] or the proof of [CDH+20, Theorem 2.5.1] for an account in the present language). Therefore, we conclude that

$$|\text{Span}(C)| \xrightarrow{c \mapsto (c \rightarrow 0)} |\text{Span}(\text{Ar}(C))| \xrightarrow{t} |\text{Span}(C)|$$

is a fibre sequence. Since $\mathcal{K}(C) = \Omega|\text{Span}(C)|$ is one possible definition of the algebraic K-space of C , looping this fibre sequence once recovers Waldhausen’s additivity theorem

$$\mathcal{K}(\text{Ar}(C)) \simeq \mathcal{K}(C) \times \mathcal{K}(C)$$

since t is clearly split and $\mathcal{K}(C)$ an \mathbb{E}_∞ -group using the direct sum in C . In this way, Proposition 3.1 connects to the discussion of additivity in [CDH+20, Section 2].

As a further application of Theorem 3.1, we can identify the cocartesian fibration corresponding to the functor $\text{Span}: \text{AdTrip} \rightarrow \text{Cat}$. More generally, let X be an ∞ -category and consider a diagram of adequate triples

$$F: X^{\text{op}} \rightarrow \text{AdTrip}.$$

Writing $p: Y \rightarrow X$ for the cartesian fibration classified by the underlying functor of F , we can use Proposition 2.7 to endow Y with the structure of an adequate triple:

Notation 3.6. By forgetting different pieces of the data, the functor $F: X^{\text{op}} \rightarrow \text{AdTrip}$ gives three diagrams of ∞ -categories F, F_{in} and F^{eg} , which are classified by three cartesian fibrations

$$p: Y = \text{Un}^{\text{ct}}(F) \rightarrow X, \quad p_{\text{in}}: Y_{\text{in}} = \text{Un}^{\text{ct}}(F_{\text{in}}) \rightarrow X \quad \text{and} \quad p^{\text{eg}}: Y^{\text{eg}} = \text{Un}^{\text{ct}}(F^{\text{eg}}) \rightarrow X,$$

respectively, where we generally denote by

$$\text{Un}^{\text{ct}}: \text{Fun}(X^{\text{op}}, \text{Cat}) \rightarrow \text{Cart}(X) \quad \text{and} \quad \text{Un}^{\text{cc}}: \text{Fun}(X, \text{Cat}) \rightarrow \text{Cocart}(X)$$

the cartesian and cocartesian unstraightening functors, respectively. In our specific situation we further write $Y_{\text{fw}}, Y_{\text{in}}^{\text{fw}}, Y_{\text{fw}}^{\text{eg}}$ for the pullback of $Y, Y_{\text{in}}, Y^{\text{eg}}$ along $\iota X \rightarrow X$. Proposition 2.7 then shows that $p: Y \rightarrow X$ is part of a map of adequate triples

$$Y^{\mathcal{J}} = (Y, Y_{\text{in}}^{\text{fw}}, Y^{\text{eg}}) \longrightarrow (X, \iota X, X)$$

which gives rise to a map

$$\text{Span}(p): \text{Span}(Y^{\mathcal{J}}) \rightarrow \text{Span}(X, \iota X, X) \simeq X^{\text{op}}. \tag{3.7}$$

We will show that this is the cocartesian fibration classifying $\text{Span} \circ F$. First we note the following:

Lemma 3.8. *The functor $\text{Span}(p)$ is a cocartesian fibration.*

Proof. Corollary 3.2 immediately implies that $\text{Span}(p)$ is a cocartesian fibration, with cocartesian edges given by spans of the form: $y' \llleftarrow y \rightrightarrows y$, where $y \rightarrow y'$ is a p^{eg} -cartesian edge in Y . \square

We will now describe the functor classified by this cocartesian fibration:

Theorem 3.9. *Let X be an ∞ -category. Then there exists a natural equivalence*

$$\alpha: \text{Un}^{\text{cc}}(\text{Span} \circ (-)) \Longrightarrow \text{Span}((\text{Un}^{\text{ct}}(-))^{\mathcal{J}})$$

of functors $\text{Fun}(X^{\text{op}}, \text{AdTrip}) \rightarrow \text{Cocart}(X^{\text{op}})$. In other words, for each $F: X^{\text{op}} \rightarrow \text{AdTrip}$, the induced cocartesian fibration (3.7) is classified by the functor $\text{Span} \circ F: X^{\text{op}} \rightarrow \text{Cat}$.

We will use the following description of (co)cartesian unstraightening from [GHN17, Theorem 7.4]:

Theorem 3.10. *For a functor $F: B \rightarrow \text{Cat}$, there is a natural equivalence*

$$\text{Un}^{\text{cc}}(F) \simeq \text{colim} \left(\text{Tw}^r(B) \xrightarrow{(s,t)} B \times B^{\text{op}} \xrightarrow{F \times B_{-/}} \text{Cat} \right).$$

Dually, for a functor $F: B^{\text{op}} \rightarrow \text{Cat}$, there is a natural equivalence

$$\text{Un}^{\text{ct}}(F) \simeq \text{colim} \left(\text{Tw}^r(B^{\text{op}}) \xrightarrow{(s,t)} B^{\text{op}} \times B \xrightarrow{F \times B_{-/}} \text{Cat} \right).$$

We will apply this in the setting of 3.6 to compute the cocartesian fibration classified by $\text{Span}(F): X^{\text{op}} \rightarrow \text{Cat}$. We find that $\text{Un}^{\text{cc}}(\text{Span}(F))$ is equivalent to the colimit of the diagram

$$\text{Tw}^r(X^{\text{op}}) \xrightarrow{(s,t)} X^{\text{op}} \times X \xrightarrow{\text{Span}(F) \times (X^{\text{op}})_-} \text{Cat}.$$

Now note that there are natural equivalences $-/X^{\text{op}} \simeq (X/-)^{\text{op}} \simeq \text{Span}(X/-, \iota(X/-), X/-)$ and recall that Span commutes with products of adequate triples to conclude that this colimit is the same as that of the diagram

$$\text{Tw}^r(X^{\text{op}}) \xrightarrow{(s,t)} X^{\text{op}} \times X \xrightarrow{F \times (X/-, \iota(X/-), X/-)} \text{AdTrip} \xrightarrow{\text{Span}} \text{Cat}.$$

We shall prove Theorem 3.9 by showing that the colimit of the first two functors in this composition is precisely $Y^f = (Y, Y_{\text{in}}^{\text{fw}}, Y^{\text{eg}})$ and that this colimit is preserved by Span .

We can directly apply the equivalence of Theorem 3.10 to conclude that

$$Y \simeq \text{colim } F(-) \times X/-, \quad Y^{\text{eg}} \simeq \text{colim } F^{\text{eg}}(-) \times X/-, \quad \text{and} \quad Y_{\text{in}} \simeq \text{colim } F_{\text{in}}(-) \times X/- \quad (3.11)$$

where all colimits are taken over $\text{Tw}^r(X^{\text{op}})$. To exhibit $Y_{\text{in}}^{\text{fw}} = Y_{\text{in}} \times_X \iota X$ as a colimit, we need the following lemma:

Lemma 3.12. *Let $F: B^{\text{op}} \rightarrow \text{Cat}$ be a functor. Then the functor $\text{Un}^{\text{ct}}(F) \times_B \iota B \rightarrow \text{Un}^{\text{ct}}(F)$ is naturally equivalent to the functor*

$$\text{colim}_{\text{Tw}^r(B^{\text{op}})} F \times \iota(B/-) \rightarrow \text{colim}_{\text{Tw}^r(B^{\text{op}})} F \times B/-. \quad (3.13)$$

Proof. Consider the full subcategory of $\text{Fun}(\text{Fun}(B^{\text{op}}, \text{Cat}), \text{Cat})/\text{Un}^{\text{ct}}$ spanned by those natural transformations $\Phi \rightarrow \text{Un}^{\text{ct}}$ with the following two properties:

- (1) At the terminal diagram, $\Phi(*) \rightarrow \text{Un}^{\text{ct}}(*) \simeq B$ exhibits the inclusion of the core of B .
- (2) For each $F: B^{\text{op}} \rightarrow \text{Cat}$, the induced square

$$\begin{array}{ccc} \Phi(F) & \longrightarrow & \text{Un}^{\text{ct}}(F) \\ \downarrow & & \downarrow \\ \Phi(*) & \hookrightarrow & B. \end{array} \quad (3.14)$$

is cartesian.

This subcategory is contractible and the natural transformation $\text{Un}^{\text{ct}}(-) \times_B \iota B \rightarrow \text{Un}^{\text{ct}}(-)$ is (by definition) an object in there. It will therefore suffice to show that the composite natural transformation

$$\Phi(F) := \text{colim}_{\text{Tw}^r(B^{\text{op}})} (F \times \iota(B/-)) \rightarrow \text{colim}_{\text{Tw}^r(B^{\text{op}})} (F \times B/-) \simeq \text{Un}^{\text{ct}}(F)$$

satisfies conditions (1) and (2) as well.

Let us start by computing $\Phi(F)$. To this end, let us write $\text{Ar}(B)_s = \text{Ar}(B) \times_B \iota B$, where the structure map $\text{Ar}(B) \rightarrow B$ is evaluation at the source. Then $t: \text{Ar}(B)_s \rightarrow B$ is the left fibration classified by the functor $b \mapsto \iota(B/b)$ and $s: \text{Ar}(B)_s \rightarrow \iota B$ admits a fully faithful left adjoint $\text{cst}: \iota B \hookrightarrow \text{Ar}(B)_s$ taking degenerate arrows. Let us now consider the following two pullbacks of ∞ -categories

$$\begin{array}{ccccc} D & \hookrightarrow & C & \xrightarrow{q} & \text{Tw}^r(B^{\text{op}}) \\ \pi \downarrow & & \downarrow & & \downarrow t \\ \iota B & \xrightarrow{\text{cst}} & \text{Ar}(B)_s & \xrightarrow{t} & B \end{array}$$

as well as the following diagram of ∞ -categories

$$F' : C \xrightarrow{q} \text{Tw}^r(B^{\text{op}}) \xrightarrow{s} B^{\text{op}} \xrightarrow{F} \text{Cat}.$$

Since $q : C \rightarrow \text{Tw}^r(B^{\text{op}})$ is the left fibration classifying $\iota(B/-) : \text{Tw}^r(B^{\text{op}}) \rightarrow B \rightarrow \text{Gpd}$ and F' is constant along the fibres of q , the left Kan extension $q_!F'$ is naturally equivalent to the diagram $F(-) \times \iota(B/-)$ of which we want to compute the colimit [Lu09a, Proposition 4.3.3.10]. By transitivity of Kan extensions, it therefore suffices to compute $\text{colim}_C F'$.

Note that the vertical arrows in the above diagram are all cartesian fibrations, so that the fully faithful inclusion $D \hookrightarrow C$ admits a (localising) right adjoint [Lu09a, Corollary 5.2.7.11]

$$p = (\text{id}, s) : C = \text{Tw}^r(B^{\text{op}}) \times_B \text{Ar}(B)_s \longrightarrow \text{Tw}^r(B^{\text{op}}) \times_B \iota B = D.$$

By construction, the diagram F' only depended on the first factor $\text{Tw}^r(B^{\text{op}})$; Consequently, it factors as $F' = F''p$, for some $F'' : D \rightarrow \text{Cat}$. Because p is a localisation, it is in particular cofinal, so we conclude that $\text{colim}_C F' \simeq \text{colim}_D F''$.

Let us first compute the left Kan extension $\pi_!F''$ of F'' along the cocartesian fibration $\pi : D \rightarrow \iota B$. We can compute this Kan extension as a colimit over the fibres, which are equivalently the fibres of $\iota : \text{Tw}^r(B^{\text{op}}) \rightarrow B$. Unravelling the definitions then shows that

$$(\pi_!F'')(b) = \text{colim}(B^{\text{op}}/b \rightarrow B^{\text{op}} \xrightarrow{F} \text{Cat}) \simeq F(b)$$

since B^{op}/b has a terminal object. We conclude that there is a natural equivalence

$$\Phi(F) = \text{colim}_{\text{Tw}^r(B^{\text{op}})} F \times \iota(B/-) \simeq \text{colim}_D F'' \simeq \text{colim}_{\iota B} \pi_!F'' \simeq \text{colim}_{\iota B} F \simeq \text{Un}^{\text{ct}}(F) \times_B \iota B.$$

In particular, we see that $\Phi(*)$ is an ∞ -groupoid, so that (1) $\Phi(*) \rightarrow B$ is a core inclusion, being a colimit of core inclusions. For (2), note that the vertical maps in (3.14) are cartesian fibrations, so that it suffices to show that the maps on vertical fibres are equivalences. By naturality of the transformation $\Phi \rightarrow \text{Un}^{\text{ct}}$ in the base B , this map on fibres map is simply the map when $B = *$. In this case, the map (3.13) is clearly an equivalence. \square

Proposition 3.15. *The diagram*

$$\Psi : \text{Tw}^r(X^{\text{op}}) \xrightarrow{(s,t)} X^{\text{op}} \times X \xrightarrow{F \times (X/-, \iota(X/-), X/-)} \text{AdTrip}$$

has colimit given by the adequate triple $Y^J = (Y, Y_{\text{in}}^{\text{fw}}, Y_{\text{eg}})$.

Proof. The equivalences (3.11) and Lemma 3.12 show that the colimit of Ψ in $\text{Fun}(\Lambda_2[2], \text{Cat})$ is given by the triple Y^J . To see that this is also a colimit in the subcategory of adequate triples, it suffices to verify that the following are equivalent for a functor $\phi : Y^J = \text{colim } \Psi \rightarrow Z$:

- (1) ϕ preserves ambigressive pullback squares.
- (2) the composite $\Psi(f^{\text{op}} : x_1 \rightarrow x_0) \rightarrow \text{colim } \Psi \rightarrow Z$ does so for each $f^{\text{op}} \in \text{Tw}^r(X^{\text{op}})$.

Now note that (on underlying ∞ -categories) the map $\Psi(f^{\text{op}} : x_1 \rightarrow x_0) \rightarrow \text{colim } \Psi$ can be identified with the functor $\lambda_f : F(x_1) \times X/x_0 \rightarrow Y$ sending $(y, g : x_2 \rightarrow x_0)$ to $g^*f^*(y)$. Because g^* is a map of adequate triples for every map g in X , λ_f is a map of adequate triples, which shows that (1) implies (2).

For the converse, note that every ambigressive pullback square in Y can be obtained as a pasting of two types of squares: (a) the pullback of a fibrewise ingressive map along a p -cartesian lift of some $g : x_2 \rightarrow x_0$ and (b) the pullback of an ingressive and egressive map in a single fibre $Y_{x_0} \simeq F(x_0)$. It suffices to show that each of these squares is the image of an ambigressive pullback square under some λ_f . For (a), we can take the image under $\lambda_{\text{id}_{x_0}}$ of the square in $F(x_0) \times X/x_0$ formed by an ingressive

arrow in $F(x_1)$ and the arrow $g \rightarrow \text{id}_{x_0}$ in X/x_0 . For (b), we simply take the image under $\lambda_{\text{id}_{x_0}}$ of an ambigressive square in $F(x_0) \times \{\text{id}_{x_0}\}$. \square

Applying Span to the colimiting cocone of Proposition 3.15, we therefore obtain a natural cocone of the diagram

$$\text{Tw}^r(X^{\text{op}}) \xrightarrow{(s,t)} X^{\text{op}} \times X \xrightarrow{F \times (X/-, \iota(X/-), X/-)} \text{AdTrip} \xrightarrow{\text{Span}} \text{Cat}$$

whose tip is the ∞ -category $\text{Span}(Y^J)$. This induces a natural functor

$$\alpha_F : \text{Un}^{\text{cc}}(\text{Span}(F)) \simeq \text{colim}_{\text{Tw}^r(X^{\text{op}})} \left(\text{Span}(F) \times (X^{\text{op}})_{-/} \right) \longrightarrow \text{Span}(Y^J) = \text{Span}(\text{Un}^{\text{ct}}(F)^J).$$

Note that the construction of α_F is functorial in the diagram F . Applied to the terminal diagram $F = *$, it yields the identity map of $\text{Span}(X, \iota X, X)$. Using the identification $\text{Span}(X, \iota X, X) \simeq X^{\text{op}}$ from Proposition 2.15, we then obtain the desired natural transformation $\alpha : \text{Un}^{\text{cc}}(\text{Span} \circ (-)) \implies \text{Span}(\text{Un}^{\text{ct}}(-)^J)$ between functors $\text{Fun}(X^{\text{op}}, \text{AdTrip}) \longrightarrow \text{Cat}/X^{\text{op}}$.

Lemma 3.16. *For each $F : X^{\text{op}} \longrightarrow \text{AdTrip}$, the functor α_F preserves cocartesian edges over X^{op} .*

Proof. Note that F comes with a natural transformation $\iota F \longrightarrow F$, where each $\iota F(x)$ comes equipped with the (only possible) adequate triple structure where all morphisms are both ingressive and egressive. Unstraightening, this identifies $\text{Un}^{\text{ct}}(\iota F)^J$ with the subcategory of $\text{Un}^{\text{ct}}(F)$ on the cartesian arrows, with all arrows egressive and only the equivalences being ingressive.

The map $\iota F \longrightarrow F$ induces a natural transformation $\iota \text{Span}(F) \simeq \text{Span}(\iota F) \longrightarrow \text{Span}(F)$, where the first equivalence uses that $\text{Span}(\iota F) \simeq \iota(F)$ (Proposition 2.15). By naturality, we then obtain a commuting diagram

$$\begin{array}{ccc} \text{Un}^{\text{cc}}(\iota \text{Span}(F)) & \xrightarrow{\alpha(\iota F)} & \text{Span}(\text{Un}^{\text{ct}}(\iota F)^J) \\ \downarrow & & \downarrow \\ \text{Un}^{\text{cc}}(\text{Span}(F)) & \xrightarrow{\alpha_F} & \text{Span}(\text{Un}^{\text{ct}}(F)^J). \end{array}$$

The result now follows since both vertical arrows can be identified with the inclusion of the wide subcategory of cocartesian arrows: for the left arrow this is evident and for the right arrow, this follows from our description of $\text{Un}^{\text{ct}}(\iota F)^J$ and Corollary 3.2. \square

Proof of Theorem 3.9. We have seen that α constitutes a natural transformation between functors into Cat/X^{op} . By Lemma 3.16, the value of α at a diagram F is a map between cocartesian fibrations over X^{op} which preserves cocartesian edges. It then suffices to show that α_F is an equivalence when restricted to every fibre [Lu09a, Corollary 2.4.4.4]. Since Span preserves pullbacks (in particular fibres), we can thus reduce to the case $X = *$, where the map is equivalent to the identity by inspection. \square

Remark 3.17. Given a functor $G : X^{\text{op}} \longrightarrow \text{Cat}$, one way to write down the cartesian fibration encoding it is to write down the cocartesian fibration which classifies $(-)^{\text{op}} \circ G$, and then take its opposite. In the case that $G = \text{Span}(F)$, Lemma 2.14 shows that $G^{\text{op}} = \text{Span}(F^{\text{rev}})$. Therefore, the previous result allows us to describe its cocartesian straightening. Finally, we can again apply Lemma 2.14 to describe the opposite of the result. In total, one finds that

$$\text{Span}(p) : \text{Span}(Y, Y_{\text{in}}, Y_{\text{fw}}^{\text{eg}}) \longrightarrow \text{Span}(X, X, \iota X) \simeq X$$

is a cartesian fibration which classifies the functor $\text{Span}(F) : X^{\text{op}} \longrightarrow \text{Cat}$.

As a special case, we recover the key insight of [BGN18].

Corollary 3.18. Let $p: Y \rightarrow X$ be a cartesian fibration and define $Y^\vee \rightarrow X^{\text{op}}$ to be the functor

$$\text{Span}(p): \text{Span}(Y, Y \times_X \iota X, Y^\dagger) \rightarrow \text{Span}(X, \iota X, X) \simeq X^{\text{op}},$$

where Y^\dagger is the subcategory of p -cartesian morphisms (cf. Proposition 2.6). This gives rise to an equivalence $\text{SD}^{\text{cc}}: \text{Cart}(X) \rightarrow \text{Cocart}(X^{\text{op}})$ which fits into a commuting triangle

$$\begin{array}{ccc} \text{Cart}(X) & \xrightarrow{\text{SD}^{\text{cc}}} & \text{Cocart}(X^{\text{op}}) \\ & \searrow \text{Str}^{\text{ct}} & \swarrow \text{Str}^{\text{cc}} \\ & \text{Fun}(X^{\text{op}}, \text{Cat}) & \end{array}$$

Proof. Note that once we have exhibited the triangle as commutative, the two-out-of-three property will immediately imply that SD^{cc} is an equivalence. We will provide a natural equivalence $\text{SD}^{\text{cc}}(\text{Un}^{\text{ct}}(F)) \rightarrow \text{Un}^{\text{cc}}(F)$ for functors $F: X^{\text{op}} \rightarrow \text{Cat}$. To this end, consider the functor $\delta: \text{Cat} \rightarrow \text{AdTrip}$ sending $C \mapsto (C, C, \iota C)$ and note that $\text{Span} \circ \delta \simeq \text{id}$. One then has natural equivalences

$$\text{SD}^{\text{cc}}(\text{Un}^{\text{ct}}(F)) \simeq \text{Span}(\text{Un}^{\text{ct}}(\delta(F))^J) \simeq \text{Un}^{\text{cc}}(\text{Span}(\delta(F))) \simeq \text{Un}^{\text{cc}}(F),$$

where the middle equivalence is Theorem 3.9. □

As another special case, we may consider the universal example.

Construction 3.19. Let us define the lax under-category $* // \text{AdTrip}$ to be the domain of the cocartesian fibration classifying the functor $(-)^{\text{op}}: \text{AdTrip} \rightarrow \text{Cat}$; see the next remark for a justification. One can identify an object of $* // \text{AdTrip}$ with a tuple (X, x) of an adequate triple and an object $x \in X$, and a map $(X, x) \rightarrow (Y, y)$ with a map $f: X \rightarrow Y$ and a map $\mu: y \rightarrow f(x)$ in Y . We will say that (f, μ) is egressive if μ is egressive, and ingressive if μ is ingressive and f is an equivalence.

Remark 3.20. If we write $* // \text{Cat}$ for the domain of the cocartesian fibration classified by $(-)^{\text{op}}: \text{Cat} \rightarrow \text{Cat}$, then $* // \text{AdTrip} = * // \text{Cat} \times_{\text{Cat}} \text{AdTrip}$. We will show in Section 7 (see specifically Remark 7.22) that $* // \text{Cat}$ really is equivalent to the lax under-category, defined a priori via a construction in $(\infty, 2)$ -category theory, justifying the notation.

Corollary 3.21. Construction 3.19 defines the structure of an adequate triple on $(* // \text{AdTrip})^{\text{op}}$ and the map

$$\text{Span}(p): \text{Span}((* // \text{AdTrip})^{\text{op}}) \rightarrow \text{Span}(\text{AdTrip}^{\text{op}}, \iota \text{AdTrip}^{\text{op}}, \text{AdTrip}^{\text{op}}) \simeq \text{AdTrip}$$

is a cocartesian fibration, classified by the functor $\text{Span}: \text{AdTrip} \rightarrow \text{Cat}$.

Proof. Apply Theorem 3.9 to the identity functor on AdTrip and observe that the adequate triple structure from 3.6 corresponds precisely to the one from Construction 3.19 under taking opposite categories. □

Remark 3.22. Applying the conclusions of Remark 3.17, we obtain that if we declare a map (f, μ) in $* // \text{AdTrip}$ to be ingressive if μ is ingressive and egressive if μ is egressive and f is an equivalence, then we obtain a different adequate triple structure on $(* // \text{AdTrip})^{\text{op}}$, which gives rise to a cartesian fibration $\text{Span}((* // \text{AdTrip})^{\text{op}}) \rightarrow \text{AdTrip}^{\text{op}}$, classifying the functor $\text{Span}: \text{AdTrip} \rightarrow \text{Cat}$.

Remark 3.23. In [Na16], Nardin proves that for an orbital ∞ -category T , the T - ∞ -category of T -commutative monoids in a T - ∞ -category C with finite T -products is equivalent to the T - ∞ -category $\text{Fun}_T^\times(\underline{\mathbf{A}}^{\text{eff}}(T), C)$, where $\underline{\mathbf{A}}^{\text{eff}}(T)$ is a cocartesian fibration whose fibre over $t \in T$ is equivalent to $\text{Span}((\mathbf{F}_T)/t)$, where \mathbf{F}_T is the finite coproduct completion of T . This indicates that T -commutative monoids are computed by a generalisation of Mackey functors. By inspecting the definition of $\underline{\mathbf{A}}^{\text{eff}}(T)$

from [Na16, Definition 4.10], one observes that $\underline{\mathbf{A}}^{\text{eff}}(T) = \text{Span}(Y^J)$, where Y is the cartesian unstraightening of the functor underlying

$$T^{\text{op}} \rightarrow \text{AdTrip}, \quad t \mapsto ((\mathbf{F}_T)/t, (\mathbf{F}_T)/t, (\mathbf{F}_T)/t),$$

where the functoriality is given by pullback. Therefore, Theorem 3.9 shows that the functoriality of the T - ∞ -category $\underline{\text{Fun}}_T^\times(\underline{\mathbf{A}}^{\text{eff}}(T), C)$ is induced by the standard functoriality of $\text{Span}(-)$.

4. Orthogonal adequate triples and their duals

Work of Barwick, Glasman and Nardin uses the span category construction from Section 2 to produce an equivalence between cartesian fibrations and cocartesian fibrations of ∞ -categories [BGN18]. In the previous section, we provided an alternative proof of this fact by exhibiting it as a specific example of a general phenomenon: the cocartesian fibration classifying $\text{Span} \circ F$ is given by the span construction applied to a particular adequate triple structure on the cartesian unstraightening of F .

In this section, we will describe a different perspective on this result, which is a priori entirely independent from the discussion of (co)cartesian fibrations. The construction of span ∞ -categories upgrades to an automorphism (of order 2) of a certain full subcategory of adequate triples spanned by those triples that we will call *orthogonal*. In Section 5, we will show how this construction interacts with various notions of (cartesian) fibrations between such orthogonal adequate triples. In particular, we will extend Lanari’s results on the relation between cartesian fibrations and factorisation systems from [La19] and thus recover the main result from [BGN18] in a different way.

To define the notion of an orthogonal adequate triple, let us start by briefly recalling Joyal’s notion of a factorisation system on an ∞ -category C (also called an *orthogonal* factorisation system), following [Lu09a, Section 5.2.8]. It consists of two classes of arrows C_l (left) and C_r (right), denoted \twoheadrightarrow and \twoheadleftarrow , such that

- (i) both classes of maps are closed under retracts,
- (ii) each solid commutative diagram

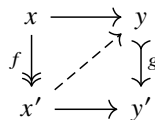

admits a unique dashed filler whenever $f \in C_l$ and $g \in C_r$, and

- (iii) every map in C factors as $\cdot \xrightarrow{f} \twoheadrightarrow \cdot \twoheadleftarrow \cdot$ with $f \in C_l$ and $g \in C_r$.

Let us point out that the notation for the left and right classes is inspired by the notation for the epi-mono factorisation system and is *opposite* to the convention typically employed for model categories.

Both C_l and C_r then define subcategories of C that contain all equivalences and each class uniquely determines the other [Lu09a, Proposition 5.2.8.6 & 5.2.8.11].

Remark 4.1. The factorisation in the last item is essentially unique, and this uniqueness is, in fact, equivalent to the first two items [Lu09a, Proposition 5.2.8.17]. More precisely, writing $\text{Fact}(C) \subseteq \text{Fun}([2], C)$ for the full subcategory of functors sending $0 \leq 1$ to C_l and $1 \leq 2$ to C_r , one has that restriction to the arrow $0 \leq 2$ defines an equivalence

$$\circ : \text{Fact}(C) \xrightarrow{\sim} \text{Ar}(C).$$

An (essentially unique) section provides a *functorial* factorisation of morphisms in C .

Definition 4.2. We call an adequate triple $(X, X_{\text{in}}, X^{\text{eg}})$ *orthogonal* if every ambigressive square in X is cartesian, and the egressives (\twoheadrightarrow) and ingressives (\twoheadleftarrow) are the left and right classes, respectively, of an

orthogonal factorisation system on X . We denote the full subcategory of orthogonal adequate triples by AdTrip^\perp .

Remark 4.3. Since every ambigressive square in an orthogonal adequate triple is automatically cartesian, it follows that AdTrip^\perp is a *full* subcategory of $\text{Fun}(\Lambda_2[2], \text{Cat})$ (in contrast to AdTrip).

The simplest examples are $(A, \iota A, A)$ and $(A, A, \iota A)$ for any ∞ -category A . We will generate more interesting examples by means of the following observation, which follows directly from the mapping properties of cartesian edges:

Proposition 4.4. *If X is an orthogonal adequate triple and $p: Y \rightarrow X$ has all p -cartesian lifts over X_{in} , then the adequate triple $(Y, Y^\dagger, p^{-1}(X^{\text{eg}}))$ from Proposition 2.6 is again orthogonal.*

In particular, for a cartesian fibration $p: Y \rightarrow X$ the triple structure on Y with ingressesives the p -cartesian edges and egressives the fibrewise maps is orthogonal; in this way, our constructions contain those from [BGN18].

Proof. The fact that any ambigressive square is cartesian follows immediately from the proof of Proposition 2.6. To show that the ingressesives and egressives form a factorisation system on Y , let us start by noting that both classes are stable under retracts (for the cartesian morphisms, this uses that they are characterised by a lifting property relative to the base X). Next, consider a commutative square

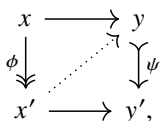

where $\phi \in Y^{\text{eg}}$ and $\psi \in Y_{\text{in}}$. We need to exhibit a unique dotted arrow making the diagram commute. After applying p , there exists a unique dotted edge in X making the square commute. Since ψ is p -cartesian, we find that there is a unique dotted edge in Y which makes the square commute. Finally, given an edge $f: x \rightarrow y$ in Y , one can factor $p(f) = gh$ with $g \in X_{\text{in}}$ and $h \in X^{\text{eg}}$. Taking a p -cartesian lift g' of g , we can factor $f = g'h'$ with $h' \in p^{-1}(X^{\text{eg}})$, so that Y^\dagger and $p^{-1}(X^{\text{eg}})$ form a factorisation system. □

Example 4.5. A product $A \times B$ of two ∞ -categories admits the structure of an orthogonal adequate triple, denoted $(A, B)^\perp$, with ingressesives $A \times \iota B$ and egressives $\iota A \times B$.

Example 4.6. Let X be a stable ∞ -category, together with reflective stable subcategories exhibiting X as a recollement [Lu17, Definition A.8.1]

$$U \begin{array}{c} \xleftarrow{j^*} \\ \xrightarrow{j_*} \end{array} X \begin{array}{c} \xrightarrow{i^*} \\ \xleftarrow{i_*} \end{array} Z;$$

explicitly, this means that i^* and j^* jointly detect equivalences and j_*i_* sends every object to the terminal object, but there are several other characterisations; see [CDH+20, Appendix A.2]. In particular, by [CDH+20, Lemma A.2.5], i_* admits a further right adjoint $i^!$ such that $i_*i^!x \rightarrow x \rightarrow j_*j^*x$ is a fibre sequence for each $x \in X$.

We now claim that X has the structure of an orthogonal adequate triple, in which a map is ingressive or egressive if its image under $i^!$ or j^* is an equivalence, respectively. By [CDH+20, Corollary 2.6.1], j^* is a cartesian fibration with an edge in X being j^* -cartesian if and only if it is an $i^!$ -equivalence. Thus, Proposition 4.4 (applied with target $(U, U, \iota U)$) yields the structure of an orthogonal triple on X as desired.

Example 4.7. For each ∞ -category A , the source projection $s: \text{Ar}(A) \rightarrow A$ is a cartesian fibration. Applying Proposition 4.4 to the triple $(A, A, \iota A)$, we find that $\text{Ar}(A)$ admits the structure of an orthogonal adequate triple in which a map is egressive (ingressive) if its image under the source map $s: \text{Ar}(A) \rightarrow A$

(target map $t: \text{Ar}(A) \rightarrow A$) is an equivalence. For every $A \rightarrow B$, the induced functor $\text{Ar}(A) \rightarrow \text{Ar}(B)$ preserves ingressive and egressive maps, so that we obtain a functor

$$\text{Ar}: \text{Cat} \longrightarrow \text{AdTrip}^\perp.$$

In fact, Example 4.7 provides the *free* orthogonal adequate triple generated by A :

Proposition 4.8. *The functor $\text{Ar}: \text{Cat} \rightarrow \text{AdTrip}^\perp$ is the left adjoint to the forgetful functor $\text{AdTrip}^\perp \rightarrow \text{Cat}$ taking underlying ∞ -categories. More precisely, the degeneracy map $\text{cst}: A \rightarrow \text{Ar}(A)$ provides the unit transformation exhibiting Ar as the left adjoint to the forgetful functor.*

Proof. It will suffice to define a natural counit map and provide natural homotopies for the triangle identities. Given an adequate triple X , let $\epsilon_X: \text{Ar}(X) \rightarrow X$ be the unique functor that fits into a commuting diagram

$$\begin{array}{ccc} \text{Fact}(X) & \hookrightarrow & \text{Fun}([2], X) \\ \circ \downarrow \sim & & \downarrow \text{ev}_1 \\ \text{Ar}(X) & \xrightarrow{\epsilon_X} & X. \end{array}$$

Here, the left vertical functor is the equivalence from Remark 4.1, a section of which provides a functorial ingressive-ingressive factorisation. Since all three solid maps are functorial in the adequate triple X , the map ϵ_X is functorial in X . Explicitly, the value of ϵ_X on a map $\mu: f \rightarrow g$ in $\text{Ar}(X)$ given by the square

$$\begin{array}{ccc} \cdot & \xrightarrow{\mu_0} & \cdot \\ \downarrow f & & \downarrow g \\ \cdot & \xrightarrow{\mu_1} & \cdot \end{array}$$

is given by the middle vertical arrow in the unique diagram

$$\begin{array}{ccc} \cdot & \xrightarrow{\mu_0} & \cdot \\ \downarrow f & & \downarrow g \\ \cdot & \xrightarrow{\mu_1} & \cdot \end{array}$$

From this, we see that ϵ_X is a map of adequate triples. Indeed, if μ is ingressive (i.e., μ_1 is an equivalence), then the middle horizontal map is ingressive by the right cancellation property for ingressives [Lu09a, Proposition 5.2.8.6 (3)], and likewise in the egressive case where μ_0 is an equivalence.

It remains to provide the triangle identities. If X is an adequate triple, then the composite

$$X \xrightarrow{\text{cst}} \text{Ar}(X) \xrightarrow{\epsilon_X} X$$

is evidently naturally equivalent to the identity (using that the functorial factorisation $\text{Ar}(X) \rightarrow \text{Fact}(X)$ sends degenerate arrows to constant diagrams). Furthermore, for an ∞ -category A , the composite

$$\text{Ar}(A) \xrightarrow{\text{cst}} \text{Ar}(\text{Ar}(A)) = \text{Fun}([1] \times [1], A) \xrightarrow{\epsilon_{\text{Ar}(A)}} \text{Ar}(A)$$

sends an arrow f to $f \xrightarrow{\sim} f$ and then applies the ingressive-egressive factorisation to this natural equivalence. This is again naturally equivalent to the identity. □

Proposition 4.9. *For any adequate triple $(X, X_{\text{in}}, X_{\text{eg}})$, the subcategory inclusions $(X_{\text{eg}})^{\text{op}}, X_{\text{in}} \rightarrow \text{Span}(X)$ from Proposition 2.15 give an orthogonal factorisation system on $\text{Span}(X)$. If the triple*

$(X, X_{\text{in}}, X^{\text{eg}})$ is furthermore orthogonal, then $(\text{Span}(X), X_{\text{in}}, (X^{\text{eg}})^{\text{op}})$ is again an orthogonal adequate triple.

Proof. To prove the first claim, we use the criterion from Remark 4.1; that is, we show that the map

$$\circ : \text{Fact}(\text{Span}(X, X_{\text{in}}, X^{\text{eg}})) \longrightarrow \text{Ar}(\text{Span}(X, X_{\text{in}}, X^{\text{eg}}))$$

is an equivalence. We first observe that this map is an equivalence on cores for all adequate triples. This assertion translates to the statement that the ∞ -groupoid of dotted extensions of the solid diagram

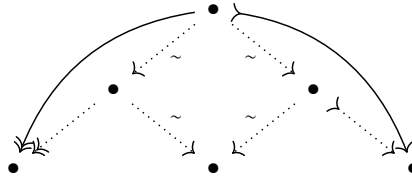

is contractible, which is obvious.

To conclude, we now observe that it suffices to show that

$$\circ_* : \text{Hom}_{\text{Cat}}([n], \text{Fact}(\text{Span}(X, X_{\text{in}}, X^{\text{eg}}))) \longrightarrow \text{Hom}_{\text{Cat}}([n], \text{Ar}(\text{Span}(X, X_{\text{in}}, X^{\text{eg}})))$$

is an equivalence for all $n \geq 0$ (in fact, $n = 1$ suffices, but this will not simplify the argument). But by Corollary 2.22 we can rewrite the target as

$$\text{Hom}_{\text{Cat}}([n] \times [1], \text{Span}(X, X_{\text{in}}, X^{\text{eg}})) \simeq \iota \text{Ar}(\text{Span}(Q_n(X, X_{\text{in}}, X^{\text{eg}}))).$$

Similarly, the source is equivalent to a set of path components in $\text{Hom}_{\text{Cat}}([2], \text{Span}(Q_n(X, X_{\text{in}}, X^{\text{eg}})))$, and we claim that it precisely corresponds to $\iota \text{Fact}(\text{Span}(Q_n(X, X_{\text{in}}, X^{\text{eg}})))$. Thus, the statement on groupoid cores applied to the various $Q_n(X, X_{\text{in}}, X^{\text{eg}})$ gives the statement in full. To verify the remaining claim, one unwinds definitions to find both sides spanned by those diagrams $\text{Tw}^r[n] \times \text{Tw}^r[2] \rightarrow X$ whose restriction along the Segal maps

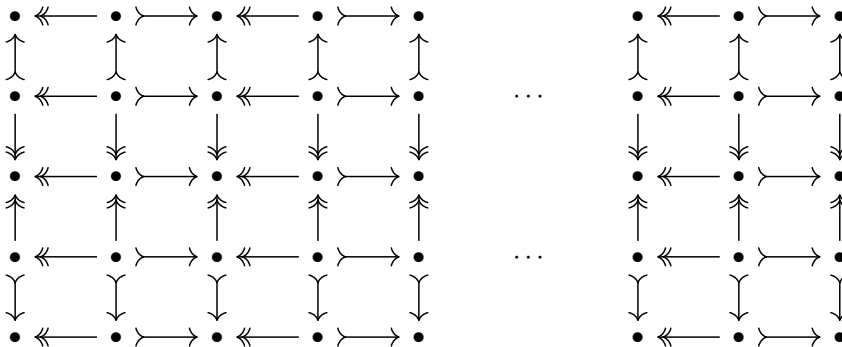

has all ambiguously marked squares cartesian and all upwards-pointing maps equivalences.

Now assume the adequate triple $(X, X_{\text{in}}, X^{\text{eg}})$ is orthogonal. To prove that $(\text{Span}(X), X_{\text{in}}, (X^{\text{eg}})^{\text{op}})$ is adequate, we must show that $\text{Span}(X)$ admits ambigressive pullbacks. By Lemma 2.14, we may equivalently show that $\text{Span}(X^{\text{rev}})$ admits ambigressive pushouts, which turns out to be notationally slightly more convenient. Let us start by observing that by adjunction, a commuting square in $\text{Span}(X^{\text{rev}})$ with horizontal arrows in $(X_{\text{in}})^{\text{op}}$ and vertical arrows in X^{eg} corresponds to a diagram of the form

satisfies right cancellation [Lu09a, Proposition 5.2.8.6 (3)], this filler is necessarily ingressive. This provides the necessary lift and concludes the argument. \square

Definition 4.10. We shall refer to $(\text{Span}(X), X_{\text{in}}, (X^{\text{eg}})^{\text{op}})$ as the *dual* of an orthogonal adequate triple $(X, X_{\text{in}}, X^{\text{eg}})$ and denote by $\text{Span}^\perp : \text{AdTrip}^\perp \rightarrow \text{AdTrip}^\perp$ the resulting functor.

Remark 4.11. Unravelling the proof above, one arrives at the following description of induced maps out of the ambigressive pushouts in $\text{Span}(X^{\text{rev}})$ from the previous proof. Suppose we are given a commutative square in $\text{Span}(X^{\text{rev}})$ represented by a diagram

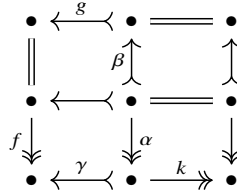

whose lower left and upper right squares are cartesian. Factor the composite fg into an egressive edge f' followed by an ingressive edge g' . From the proof above, we learn that the pushout of the two spans starting in the upper left corner is given by the source of g' (or equivalently the target of f'). The induced map out of it unwinds to the span

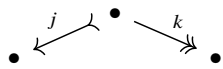

where j is the solution of the lifting problem

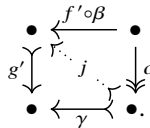

As a consistency check, note that j is indeed ingressive, as both γ and g' are.

The remainder of this section is dedicated to proving the following result:

Theorem 4.12. *The functor Span^\perp is an auto-equivalence of AdTrip^\perp , which is its own inverse.*

Below in Corollary 5.7, we will upgrade this equivalence to a C_2 -action. In the large, our strategy of proof is the same as that of Barwick, Glasman and Nardin in [BGN18], who essentially treat the special case corresponding to factorisation systems given by (co)cartesian edges and morphisms lying in a single fibre.

We have to construct a natural equivalence between $\text{Span}^{\perp 2} = \text{Span}^\perp \circ \text{Span}^\perp$ and the identity of AdTrip^\perp . To do this, let us start by describing the composite $\text{Span}^{\perp 2}$ more explicitly.

Observation 4.13. Let us write $\iota Q^\sharp : \text{sGpd} \rightarrow \text{sGpd}$ for the functor sending a simplicial ∞ -groupoid S to the simplicial ∞ -groupoid given by

$$\iota Q_n^\sharp(S) = \text{Hom}_{\text{sGpd}}(\text{N Tw}^r([n]), S).$$

By the definition of span ∞ -categories (see Lemma 2.17), there is a natural transformation of functors $\text{AdTrip} \rightarrow \text{sGpd}$

$$\text{N}(\text{Span}(X)) \hookrightarrow \iota Q^\sharp(\text{N}(X)).$$

In every simplicial degree, this is given by the inclusion of path components

$$\text{Hom}_{\text{AdTrip}}(\text{Tw}^r([n]), X) \subseteq \text{Hom}_{\text{Cat}}(\text{Tw}^r([n]), X).$$

Applying this reasoning twice, one sees that for X in AdTrip^\perp , there is a natural map of simplicial ∞ -groupoids

$$\mathbf{N}(\text{Span}^{\perp 2}(X)) \hookrightarrow \iota\mathbf{Q}^\sharp(\mathbf{N}(\text{Span}^\perp(X))) \hookrightarrow \iota\mathbf{Q}^\sharp(\iota\mathbf{Q}^\sharp(\mathbf{N}X)),$$

which is an inclusion of path components in each degree. To unravel the target of the above map, let us denote by

$$\text{Tw}^{(2)}(A) = \text{Tw}^r(\text{Tw}^r(A))$$

the twofold iterated twisted arrow ∞ -category of an ∞ -category A . We then obtain a natural equivalence

$$\begin{aligned} \iota\mathbf{Q}_n^\sharp(\iota\mathbf{Q}^\sharp(\mathbf{N}X)) &\simeq \text{Hom}_{\text{sGpd}}\left(\mathbf{N}\text{Tw}^r([n]), \iota\mathbf{Q}^\sharp(\mathbf{N}X)\right) \\ &\simeq \lim_{[m] \in \Delta/\mathbf{N}(\text{Tw}^r([n]))} \text{Hom}_{\text{sGpd}}(\mathbf{N}\text{Tw}^r([m]), \mathbf{N}X) \\ &\simeq \text{Hom}_{\text{sGpd}}(\mathbf{N}(\text{Tw}^{(2)}([n])), \mathbf{N}X) \\ &\simeq \text{Hom}_{\text{Cat}}(\text{Tw}^{(2)}([n]), X). \end{aligned}$$

Here, the third line uses that $\mathbf{N}\text{Tw}^r(-)$ preserves those colimits of ∞ -categories that are preserved by the nerve functor (see the proof of Proposition 2.20). Summarising, we see that there is a map of simplicial ∞ -groupoids, depending functorially on $X \in \text{AdTrip}^\perp$, which is a degreewise inclusion of path components

$$\mathbf{N}(\text{Span}^\perp \circ \text{Span}^\perp(X)) \hookrightarrow \text{Hom}_{\text{Cat}}(\text{Tw}^{(2)}(-), X). \tag{4.14}$$

To identify the essential image of (4.14), let us make the following construction:

Construction 4.15. Note that $\text{Tw}^{(2)}([n])$ is equivalent to the poset whose objects are tuples $abcd$ with $0 \leq a \leq b \leq c \leq d \leq n$, corresponding to a map $(a \leq d) \rightarrow (b \leq c)$ in $\text{Tw}^r([n])$. The partial order is then given by $abcd \leq a'b'c'd'$ when $a \leq a' \leq b' \leq b \leq c \leq c' \leq d' \leq d$. We define the following four wide subcategories of $\text{Tw}^{(2)}([n])$:

- (1) $\text{Tw}^{(2)}([n])_1$ is the subcategory spanned by the edges $abcd \rightarrow a'bcd$.
- (2) $\text{Tw}^{(2)}([n])_2$ is the subcategory spanned by the edges $ab'cd \rightarrow abcd$.
- (3) $\text{Tw}^{(2)}([n])_3$ is the subcategory spanned by the edges $abcd \rightarrow abc'd$.
- (4) $\text{Tw}^{(2)}([n])_4$ is the subcategory spanned by the edges $abcd' \rightarrow abcd$.

Proposition 4.16. *Let $X \in \text{AdTrip}^\perp$ and let $[n] \in \Delta$. Then the natural transformation (4.14) identifies the domain with those path components in $\text{Hom}_{\text{Cat}}(\text{Tw}^{(2)}([n]), X)$ consisting of maps $f : \text{Tw}^{(2)}([n]) \rightarrow X$ that restrict to*

$$\begin{aligned} \text{Tw}^{(2)}([n])_1 &\xrightarrow{f} X_{\text{in}} & \text{Tw}^{(2)}([n])_2 &\xrightarrow{f} \iota X \\ \text{Tw}^{(2)}([n])_3 &\xrightarrow{f} X^{\text{eg}} & \text{Tw}^{(2)}([n])_4 &\xrightarrow{f} \iota X. \end{aligned}$$

Proof. A functor

$$f : [n] \rightarrow \text{Span}^\perp \circ \text{Span}^\perp(X)$$

corresponds by adjunction to a map $\text{Tw}^r([n]) \rightarrow \text{Span}^\perp(X)$ of adequate triples – that is, a map of ∞ -categories $f' : \text{Tw}^r([n]) \rightarrow \text{Span}^\perp(X)$ such that

$$f'(\text{Tw}^r([n])_{\text{in}}) \subseteq \text{Span}^\perp(X)_{\text{in}} \quad \text{and} \quad f'(\text{Tw}^r([n])^{\text{eg}}) \subseteq \text{Span}^\perp(X)^{\text{eg}}.$$

Here, we importantly use that every ambigressive square in the target is automatically a pullback; otherwise, the functor f' would have to furthermore preserve ambigressive pullbacks. By Theorem 2.18, the map of ∞ -categories underlying f' corresponds itself to a map $\text{Tw}^r(\text{Tw}^r([n])) \rightarrow X$ of adequate triples; that is, a map $f'' : \text{Tw}^r(\text{Tw}^r([n])) \rightarrow X$ such that

$$f''\left(\text{Tw}^r(\text{Tw}^r([n]))_{\text{in}}\right) \subseteq X_{\text{in}} \quad \text{and} \quad f''\left(\text{Tw}^r(\text{Tw}^r([n]))^{\text{eg}}\right) \subseteq X^{\text{eg}}.$$

Let us now unravel these conditions using the description of $\text{Tw}^{(2)}([n])$ from Construction 4.15. Note that, on the one hand, $\text{Tw}^r(\text{Tw}^r([n]))_{\text{in}}$ consists of maps of tuples of the form $abcd \leq a'bcd'$, while $\text{Tw}^r(\text{Tw}^r([n]))^{\text{eg}}$ consists of maps $abcd \leq ab'c'd$. On the other hand, $\text{Tw}^r(\text{Tw}^r([n]))_{\text{in}}$ consists of maps of the form $abcc \leq a'b'cc$ and $\text{Tw}^r(\text{Tw}^r([n]))^{\text{eg}}$ consists of maps $aacd \leq aac'd'$.

Furthermore, $\text{Span}^\perp(X)_{\text{in}}$ is the subcategory consisting of spans of the form $\cdot \xleftarrow{\sim} \cdot \xrightarrow{\cdot} \cdot$, where the right map is in X_{in} . Similarly, $\text{Span}^\perp(X)^{\text{eg}}$ is the subcategory whose morphisms are spans of the form $\cdot \xleftarrow{\cdot} \cdot \xrightarrow{\sim} \cdot$, where the left map is in X^{eg} . Combining all this, the above conditions translate as follows:

- (1) Every $abcd \leq a'bcd'$ is mapped to X_{in} .
- (2) Every $abcd \leq ab'c'd$ is mapped to X^{eg} .
- (3) Every $abcc \leq a'b'cc$ is sent to X_{in} and every $abcc \leq ab'cc$ is sent to an equivalence.
- (4) Every $aacd \leq aac'd'$ is sent to X^{eg} and every $aacd \leq aacd'$ is sent to an equivalence.

Note that these conditions are certainly implied by the ones from the proposition. Conversely, given these conditions, the ones from the statement follow: for example, the map $abcd \leq abcd'$ fits into a square

$$\begin{array}{ccc} aacd & \longrightarrow & aacd' \\ \downarrow & & \downarrow \\ abcd & \longrightarrow & abcd'. \end{array}$$

The top horizontal arrow is mapped to an equivalence in X by (4), and the vertical arrows are sent to maps over X^{eg} by (2). In particular, the bottom arrow maps to X^{eg} , but also to X_{in} by (1). An edge which is in both the left and right part of an orthogonal factorisation system is an equivalence, and therefore, $abcd \leq abcd'$ maps to an equivalence. \square

Let us write $\text{LTw}^{(2)}([n])$ for the localisation of $\text{Tw}^{(2)}([n])$ at the classes of maps (2) and (4) and let $\text{LTw}^{(2)}([n])_1$ and $\text{LTw}^{(2)}([n])_3$ be its wide subcategories generated by the images of the maps (1) and (3) from Construction 4.15. Since each map in Δ induces a map $\text{Tw}^{(2)}([m]) \rightarrow \text{Tw}^{(2)}([n])$ preserving these four classes of maps, it follows that the triple of ∞ -categories

$$(\text{LTw}^{(2)}([n]), \text{LTw}^{(2)}([n])_1, \text{LTw}^{(2)}([n])_3) \in \text{Fun}(\Lambda_2[2], \text{Cat}) \tag{4.17}$$

depends functorially on $[n]$. Proposition 4.16 implies that the ∞ -groupoid $\text{N}(\text{Span}^{\perp 2}(X))_n$ is naturally equivalent to the ∞ -groupoid of maps in $\text{Fun}(\Lambda_2[2], \text{Cat})$

$$\left(\text{LTw}^{(2)}([n]), \text{LTw}^{(2)}([n])_1, \text{LTw}^{(2)}([n])_3\right) \longrightarrow (X, X_{\text{in}}, X^{\text{eg}}).$$

We will now identify the localised triples (4.17) more explicitly. To do this, consider the composition

$$[k] \times [1] \rightarrow [k] \star [k] \rightarrow [k] \star [k]^{\text{op}} \star [k] \star [k]^{\text{op}},$$

where the first map is the unique natural transformation between the two inclusions $[k] \rightarrow [k] \star [k]$ of the summands into the join. This induces a natural transformation

$$z : \text{Tw}^{(2)}(-) \longrightarrow \text{Ar}(-)$$

sending a tuple $abcd$ in $\text{Tw}^{(2)}([n])$ to ac in $\text{Ar}([n])$. Recall from Example 4.7 that the arrow category $\text{Ar}([n])$ comes equipped with the structure of an adequate triple in which a map is egressive (ingressive) if its image under the source (target) map is an equivalence. The map z then sends the maps (2) and (4) to equivalences, the maps (1) to ingressive arrows and the maps (3) to egressive arrows. Consequently, we obtain a natural transformation of cosimplicial diagrams in $\text{Fun}(\Lambda_2[2], \text{Cat})$

$$\left(\text{LTw}^{(2)}(-), \text{LTw}^{(2)}(-)_1, \text{LTw}^{(2)}(-)_3 \right) \longrightarrow \text{Ar}(-). \tag{4.18}$$

Restriction along this diagram of triples then induces a natural map of simplicial ∞ -groupoids

$$\zeta : \mathbf{N}(X) \simeq \text{Hom}_{\text{AdTrip}^\perp}(\text{Ar}(-), X) \longrightarrow \text{Hom}_{\text{Fun}(\Lambda_2[2], \text{Cat})}(\text{LTw}^{(2)}(-), X) \simeq \mathbf{N}\text{Span}^{\perp 2}(X)$$

for every $X \in \text{AdTrip}^\perp$. Here, the first equivalence follows from the fact that $\text{Ar}([n])$ is the free orthogonal adequate triple generated by $[n]$, by Proposition 4.8.

Lemma 4.19. *For every $X \in \text{AdTrip}^\perp$, the natural transformation ζ is an equivalence of complete Segal ∞ -groupoids.*

Proof. Since the domain and the target of ζ are complete Segal ∞ -groupoids, ζ is an equivalence of simplicial ∞ -groupoids as soon as it induces an equivalence in simplicial degrees 0 and 1. It therefore suffices to show that the natural transformation (4.18) is an equivalence of triples of ∞ -categories for $n = 0$ or $n = 1$.

For $n = 0$, this is evident since the domain and codomain of (4.18) are both just a point. For $n = 1$, at the level of the underlying ∞ -categories, we have to verify that the functor $z : \text{Tw}^{(2)}([1]) \longrightarrow \text{Ar}([1])$ exhibits $\text{Ar}([1])$ as the localisation of $\text{Tw}^{(2)}([1])$ at the maps in $\text{Tw}^{(2)}([1])_2$ and $\text{Tw}^{(2)}([1])_4$. The map z is given by the map

$$(0000 \longleftarrow 0001 \longrightarrow 0011 \longleftarrow 0111 \longrightarrow 1111) \longrightarrow (00 \longrightarrow 01 \longrightarrow 11)$$

collapsing the two left-pointing arrows. This is manifestly a localisation. Furthermore, under the map z , the noninvertible arrow in $\text{Tw}^{(2)}([1])_1$ (i.e., $0111 \rightarrow 1111$) is sent to the ingressive $01 \rightarrow 11$ and the noninvertible arrow in $\text{Tw}^{(2)}([1])_3$ (i.e., $0001 \rightarrow 0011$) is sent to the egressive $00 \rightarrow 01$. We conclude that the map $\text{LTw}^{(2)}([1]) \longrightarrow \text{Ar}([1])$ is an equivalence of (adequate) triples, as desired. \square

Proof of Theorem 4.12. Lemma 4.19 shows that after post-composing with the forgetful functor $U : \text{AdTrip} \rightarrow \text{Cat}$, there is a natural equivalence

$$\zeta : U(X) \xrightarrow{\sim} U(\text{Span}^{\perp 2}(X)).$$

It remains to verify that this equivalence on the underlying ∞ -categories also identifies the subcategories of ingressives and egressives. But this is a direct consequence of the naturality of ζ in $X \in \text{AdTrip}^\perp$, since the inclusions $\text{Span}^{\perp 2}(X)_{\text{in}} \hookrightarrow \text{Span}^{\perp 2}(X) \hookrightarrow \text{Span}^{\perp 2}(X)^{\text{eg}}$ arise as the functors underlying the maps of adequate triples

$$\text{Span}^{\perp 2}(X_{\text{in}}, X_{\text{in}}, \iota X) \longrightarrow \text{Span}^{\perp 2}(X) \longleftarrow \text{Span}^{\perp 2}(X^{\text{eg}}, \iota X, X^{\text{eg}})$$

and the same for $X_{\text{in}} \hookrightarrow X \hookrightarrow X^{\text{eg}}$. \square

5. Cartesian fibrations between orthogonal adequate triples

The purpose of this section is to analyse the interaction between orthogonal adequate triples and cartesian fibrations. In particular, we show that orthogonal adequate triples $(X, X_{\text{in}}, X^{\text{eg}})$ uniquely correspond to cartesian fibrations with contractible fibres, by taking X to $X \rightarrow X[(X^{\text{eg}})^{-1}]$, generalising results of

Lanari [La19]. More generally, we study various kinds of fibrations between adequate triples that are preserved (or exchanged) by the dualisation equivalence from Theorem 4.12. When the base X arises from a product of two ∞ -categories (Example 4.5), we can identify these fibrations with the two-variable fibrations studied extensively in [HHLN23]; this specialisation will occupy the next section.

The main notion this section will be concerned with is the following:

Definition 5.1. We will say that a map $p: Y \rightarrow X$ of orthogonal adequate triples is an *ingressive cartesian fibration* if Y admits all p -cartesian lifts over X_{in} and these precisely make up Y_{in} . Given an orthogonal adequate triple X , we will write $\text{Cart}_{\text{in}}(X) \subseteq \text{AdTrip}^{\perp}/X$ for the full subcategory on the ingressive cartesian fibrations.

Observation 5.2. Let us make the following remarks:

- (1) Let $p: Y \rightarrow X$ be an ingressive cartesian fibration. By definition, Y has all p -cartesian lifts over X_{in} , and Y_{in} is the wide subcategory on the p -cartesian lifts of ingressive morphisms. Since Y_{in} and Y^{eg} form a factorisation system, this determines Y^{eg} uniquely and we find that Y arises exactly from the construction in Proposition 4.4; in particular, $Y^{\text{eg}} = p^{-1}(X^{\text{eg}})$.
- (2) For a map of orthogonal adequate triples $p: Y \rightarrow X$, an ingressive edge g in Y is p -cartesian if and only if it is p_{in} -cartesian, since lifting an arbitrary map $f: x \rightarrow x'$ in an orthogonal adequate triple along an ingressive $g: z \rightarrow x'$ is equivalent to lifting $f': w \rightarrow x'$ along g where $f = f'h$ is the factorisation of f into an egressive followed by an ingressive.
- (3) Ingressive cartesian fibrations are stable under pullbacks. In particular, if $p: Y \rightarrow X$ is an ingressive cartesian fibration and $x \in X$, then the fibre over x carries the structure of an orthogonal adequate triple $(Y_x, \iota Y_x, Y_x)$.

We start with the following partial converse to Proposition 4.4:

Proposition 5.3. Let $(X, X_{\text{in}}, X^{\text{eg}})$ be an orthogonal adequate triple. Then the map

$$p: (X, X_{\text{in}}, X^{\text{eg}}) \rightarrow (X[(X^{\text{eg}})^{-1}], X[(X^{\text{eg}})^{-1}], \iota(X[(X^{\text{eg}})^{-1}]))$$

is an ingressive cartesian fibration. In other words, $p: X \rightarrow X[(X^{\text{eg}})^{-1}]$ is a cartesian fibration, inverts only the egressives in X , and the ingressive maps in X are precisely the p -cartesian edges.

Before we dive into the proof, we spell out some consequences. To this end, let us write Cart for the subcategory of $\text{Ar}(\text{Cat})$ spanned by objects the cartesian fibrations and by morphisms those squares

$$\begin{array}{ccc} X & \xrightarrow{f} & Y \\ p \downarrow & & \downarrow q \\ S & \longrightarrow & T \end{array}$$

such that f sends p -cartesian edges to q -cartesian edges. By Proposition 5.3, the assignment $X \mapsto (X \rightarrow X[(X^{\text{eg}})^{-1}])$ extends to a functor

$$\mathcal{L}^{\text{eg}}: \text{AdTrip}^{\perp} \rightarrow \text{Cart},$$

which is fully faithful by the universal property of a localisation. We claim that the assignment of the orthogonal adequate triple $(Y, Y^{\dagger}, p^{-1}(\iota S))$ to a cartesian fibration $p: Y \rightarrow S$ defines a right adjoint to \mathcal{L}^{eg} . Both

$$\text{Hom}_{\text{Cart}}(X \rightarrow X[(X^{\text{eg}})^{-1}], p) \quad \text{and} \quad \text{Hom}_{\text{AdTrip}}(X, (Y, Y^{\dagger}, p^{-1}(\iota S)))$$

are given by those functors $X \rightarrow Y$ that take ingressives and egressives to p -cartesian and fibrewise maps, respectively.

Proposition 5.4. *The functor \mathcal{L}^{eg} restricts to an equivalence between the category AdTrip^{\perp} and the full subcategory of Cart spanned by those cartesian fibrations whose fibres all have contractible realisations.*

Given the discussion above, this follows immediately from the equivalence between the first and third items in the following:

Lemma 5.5. *For a cartesian fibration $p: A \rightarrow B$, the following conditions are equivalent:*

- (1) *p is a localisation,*
- (2) *p is cofinal, and*
- (3) *the realisations of the fibres of p are contractible.*

Proof. It is generally true that localisations are cofinal (and coinitial). If p is a localisation, it follows straight from the definition of Kan extension as an adjoint to restriction that any functor $F: B \rightarrow C$ is right (and left) Kan extended from its restriction along p and thus has the same colimit as Fp . This proves (1) \Rightarrow (2).

To see that (2) \Leftrightarrow (3), we observe that the inclusion

$$p^{-1}(b) \subseteq b/p, \quad a \longrightarrow (a, \text{id}_b),$$

where b/p denotes the pullback $b/B \times_B A$ along p , admits a right adjoint, given by taking $(a, f: b \rightarrow p(a))$ to a p -cartesian lift of f ending at a . Thus, $|p^{-1}(b)| \simeq |b/p|$, whence the claim follows from Joyal’s cofinality criterion [Lu09a, Theorem 4.1.3.1].

To finally see that (3) \Rightarrow (1), consider for some ∞ -category C the functor

$$p^*: \text{Fun}(B, C) \longrightarrow \text{Fun}^{\text{w}}(A, C),$$

where the superscript on the right denotes those functors inverting all maps that p inverts. We have to show that p^* is an equivalence. We first claim that it has a right adjoint p_* . By [Lu09a, 4.3.3.7], this will follow from

$$b/p \xrightarrow{\text{fgt}} A \xrightarrow{F} C,$$

admitting a limit for every $b \in B$ and $F: A \rightarrow C$ that inverts the fibrewise maps. But as we just discussed above, the inclusion $p^{-1}(b) \subseteq b/p$ admits a right adjoint and is thus coinitial, so we may instead consider

$$p^{-1}(b) \subseteq A \xrightarrow{F} C,$$

which factors through the localisation $p^{-1}(b) \rightarrow |p^{-1}(b)|$ since F inverts all fibrewise maps by assumption. Thus, the assumption $|p^{-1}(b)| \simeq *$ implies that $F(a)$ is a limit of the above diagram for any $a \in p^{-1}(b)$. It also follows from the formula for the adjoint as a right Kan extension that the unit and counit of the adjunction (p^*, p_*) are equivalences, as desired. \square

Example 5.6. A cartesian fibration $p: X \rightarrow S$ is called *pointed* if both X and S have a terminal object and p preserves it. In [La19], Lanari shows that the ∞ -category of pointed cartesian fibrations is equivalent to a certain subcategory of factorisation systems (he calls them cartesian).

To see the relationship between this equivalence and ours, note that every fibre X_s of a pointed cartesian fibration admits a final object, given by the source x of a cartesian edge $x \rightarrow *$, which lies over the unique map $s \rightarrow *$ in S . Therefore, the fibre of pointed cartesian fibrations have contractible realisations, and we conclude that our equivalence extends that of [La19].

In fact, in the case of pointed cartesian fibrations, Lemma 5.5 can be sharpened. It is easy to check that assigning to some $s \in S$ the source x of a cartesian lift $x \rightarrow *$ of $s \rightarrow *$ defines a right adjoint to p , so that any pointed cartesian fibration is, in fact, a left Bousfield localisation. As a typical application, one finds that an exact functor between stable ∞ -categories is a cartesian fibration if and only if it is a

right split Verdier projection (in the language of [CDH+20, Appendix A]), and both a cartesian and a cocartesian fibration if and only if it participates (as j^*) in a stable recollement as in Example 4.6.

Corollary 5.7. *The self-equivalence Span^\perp upgrades to a C_2 -action on AdTrip^\perp .*

Proof. According to Corollary 3.18 above, the embedding $\mathcal{L}^{\text{eg}} : \text{AdTrip}^\perp \rightarrow \text{Cart}$ from Proposition 5.4 translates Span^\perp to the functor that takes a cartesian fibration to its fibrewise opposite (defined via straightening, postcomposing with $(-)^{\text{op}} : \text{Cat} \rightarrow \text{Cat}$, and then unstraightening). Since $\text{Aut}(\text{Cat}) \simeq C_2$ by Toën’s theorem [To05], this latter operation defines a C_2 -action, and hence, so does the former. \square

It would be interesting to provide a more direct construction of the coherences for this C_2 -action that does not rely on the (un)straightening equivalence, but we have not pursued this.

As another consequence, we obtain the following description of free cartesian fibrations, a generalisation of which was already proven by different means in [GHN17]:

Corollary 5.8. *Consider the functor $\text{Cart} \rightarrow \text{Cat}$ sending a cartesian fibration $p : Y \rightarrow X$ to its domain Y . This functor admits a left adjoint sending A to the cartesian fibration $s : \text{Ar}(A) \rightarrow A$.*

Proof. The forgetful functor factors as $\text{Cart} \rightarrow \text{AdTrip}^\perp \rightarrow \text{Cat}$. The first functor has left adjoint \mathcal{L}^{eg} by Proposition 5.4, and the second has left adjoint Ar by Proposition 4.8. The composite precisely sends A to $s : \text{Ar}(A) \rightarrow A$, since this has contractible fibres and the associated orthogonal triple structure on $\text{Ar}(A)$ is precisely that from Example 4.7. \square

We now come to the proof of Proposition 5.3.

Proof of Proposition 5.3. Let us start by recalling the model for $X[(X^{\text{eg}})^{-1}]$ given by the relative Rezk nerve [MG19]. For each $[n]$, let us write

$$\mathbb{N}^{\text{rel}}(X)(n) \hookrightarrow \text{Fun}([n], X)$$

for the subcategory of all functors $[n] \rightarrow X$ and natural transformations which are pointwise egressive. The core of this ∞ -category is simply $\text{Hom}_{\text{Cat}}([n], X)$. Taking geometric realisations, we then obtain a map of simplicial ∞ -groupoids

$$\mathbb{N}(X) = \text{Hom}_{\text{Cat}}(-, X) \longrightarrow |\mathbb{N}^{\text{rel}}(X)|$$

such that the induced map on associated ∞ -categories is the localisation $X \rightarrow X[(X^{\text{eg}})^{-1}]$.

We are now going to give a smaller description of $|\mathbb{N}^{\text{rel}}(X)|$, which will show in particular that it already satisfies the Segal condition (so that the associated ∞ -category is just its completion). To this end, consider the full subcategories

$$\mathbb{N}_{\text{in}}^{\text{rel}}(X)(n) \subseteq \mathbb{N}^{\text{rel}}(X)(n)$$

whose objects are functors $[n] \rightarrow X$ with values in X_{in} . For each $\alpha \in \mathbb{N}^{\text{rel}}(X)(n)$, there exists an initial $\tilde{\alpha}$ in $\mathbb{N}_{\text{in}}^{\text{rel}}(X)(n)$ equipped with a map from α , given by the unique factorisation (starting at the end)

$$\begin{array}{ccccccc} \alpha(0) & \longrightarrow & \alpha(1) & \longrightarrow & \dots & \longrightarrow & \alpha(n-1) & \longrightarrow & \alpha(n) \\ \Downarrow & & \Downarrow & & & & \Downarrow & & \parallel \\ \tilde{\alpha}(0) & \succrightarrow & \tilde{\alpha}(1) & \succrightarrow & \dots & \succrightarrow & \tilde{\alpha}(n-1) & \succrightarrow & \tilde{\alpha}(n). \end{array}$$

It follows that each inclusion $N_{in}^{rel}(X)(n) \hookrightarrow N^{rel}(X)(n)$ admits a left adjoint. We thus obtain a diagram of simplicial categories

$$\begin{array}{ccccc}
 N(X_{in}) & \longrightarrow & N_{in}^{rel}(X) & \longrightarrow & |N_{in}^{rel}(X)| \\
 \downarrow & & \downarrow & & \downarrow \sim \\
 N(X) & \longrightarrow & N^{rel}(X) & \longrightarrow & |N^{rel}(X)|,
 \end{array} \tag{5.9}$$

where the objects on the left and on the right are simplicial ∞ -groupoids and the right vertical map is an equivalence, since it is given in each simplicial degree by the geometric realisation of a right adjoint functor.

The simplicial ∞ -category $N_{in}^{rel}(X)$ satisfies the Segal conditions. The equivalence $\text{Fun}([n], X) \simeq \text{Fun}([1], X) \times_X \cdots \times_X \text{Fun}([1], X)$ restricts to an equivalence of ∞ -categories

$$N_{in}^{rel}(X)([n]) \longrightarrow N_{in}^{rel}(X)([1]) \times_{N_{in}^{rel}(X)(0)} \cdots \times_{N_{in}^{rel}(X)(0)} N_{in}^{rel}(X)([1]). \tag{5.10}$$

Here, the pullbacks are taken along the source and target functors. The target functor

$$t: N_{in}^{rel}(X)([1]) \longrightarrow N_{in}^{rel}(X)(\{1\}) = X^{eg} \tag{5.11}$$

is both a left fibration (since each $\succrightarrow \twoheadrightarrow$ fits into a unique ambigressive square) and a right fibration (since ingressive maps can be pulled back along egressive maps). This implies that the pullbacks along t in (5.10) induce pullbacks after taking realisations (see again [St21, St22] or the proof of [CDH+20, Theorem 2.5.1] for the more (co)cartesian version of this assertion), so that the equivalent simplicial ∞ -groupoids on the right in (5.9) also satisfy the Segal conditions.

We will use this description of $X[(X^{eg})^{-1}]$ in terms of $N_{in}^{rel}(X)$ to identify its over-categories. To this end, recall that for any Segal ∞ -groupoid S and $s \in S(0)$, the simplicial ∞ -groupoid

$$(S/s)(n) = S([n+1]) \times_{S(\{n+1\})} \{s\} \tag{5.12}$$

is again a Segal ∞ -groupoid, such that the associated ∞ -category $\text{ac}(S/s) \simeq \text{ac}(S)/s$ is a model for the over-category of s [CDH+20, Lemma 2.4.7]. Let us now take an object $x \in X$ and consider the maps of simplicial ∞ -groupoids induced by the top row in (5.9)

$$N(X_{in})/x \longrightarrow |N_{in}^{rel}(X)/x| \longrightarrow |N_{in}^{rel}(X)|/x. \tag{5.13}$$

Here, the middle term is given by first taking (5.12) at the level of simplicial ∞ -categories and then taking realisations. Unraveling the definitions, the simplicial ∞ -category $N_{in}^{rel}(X)/x$ is given in degree n by the ∞ -category with objects $\alpha(0) \succrightarrow \cdots \succrightarrow \alpha(n) \succrightarrow x$ and morphisms

$$\begin{array}{ccccccc}
 \alpha(0) & \succrightarrow & \alpha(1) & \succrightarrow & \dots & \succrightarrow & \alpha(n) & \succrightarrow & x \\
 \downarrow & & \downarrow & & & & \downarrow & & \parallel \\
 \beta(0) & \succrightarrow & \beta(1) & \succrightarrow & \dots & \succrightarrow & \beta(n) & \succrightarrow & x.
 \end{array}$$

Since the ingressesives and egressives form a factorisation system, all vertical maps are equivalences. Consequently, the first map in (5.13) is an equivalence (even before taking geometric realisations). In addition, since the target map (5.11) is a Kan fibration, so is the map $N_{in}^{rel}(X)([n+1]) \rightarrow N_{in}^{rel}(X)(\{n+1\})$ (being a composite of its base changes). It follows that the pullbacks (5.12) are preserved under taking classifying ∞ -groupoids, so that the second map in (5.13) is an equivalence. Since $|N_{in}^{rel}(X)|$ has associated ∞ -category $X[(X^{eg})^{-1}]$, the associated ∞ -category of $|N_{in}^{rel}(X)|/x$ is $X[(X^{eg})^{-1}]/p(x)$.

All in all, we have therefore found that for each object $x \in X$, the composite functor

$$X_{\text{in}}/x \xrightarrow{\iota} X/x \xrightarrow{p} X[(X^{\text{eg}})^{-1}]/p(x)$$

is an equivalence. Under this equivalence, the functor p is identified with the functor $X/x \rightarrow X_{\text{in}}/x$ sending each $y \rightarrow x$ to the ingressive part $y' \rightarrow x$ of its functorial egressive-ingressive factorisation. This functor admits a fully faithful right adjoint, whose essential image is given by the ingressive maps to x . By [AF20, Lemma 2.16], this implies that p is a cartesian fibration and that an arrow in X is p -cartesian if and only if it is ingressive.

In particular, we can apply Proposition 4.4 to obtain an orthogonal triple structure on X whose ingressives are the p -cartesian arrows and whose egressives are the maps that are inverted by p . Since the first class coincides with X_{in} , the second class coincides with X^{eg} . \square

We now turn to more restrictive types of fibrations between orthogonal triples:

Definition 5.14. An ingressive cartesian fibration $p: Y \rightarrow X$ is said to be

- (1) an *op-Gray fibration* if $p^{\text{eg}}: Y^{\text{eg}} \rightarrow X^{\text{eg}}$ is a cartesian fibration, and
- (2) a *curved orthofibration* if $p^{\text{eg}}: Y^{\text{eg}} \rightarrow X^{\text{eg}}$ is a cocartesian fibration.

For X an orthogonal adequate triple, we will write $\text{CrvOrtho}(X), \text{OpGray}(X)$ for the subcategories of $\text{Cart}_{\text{in}}(X)$ spanned by the curved orthofibrations and op-Gray fibrations, and maps between them preserving (in addition) p^{eg} -(co)cartesian morphisms.

Remark 5.15. To avoid confusion, we would like to explicitly mention that while arrows with the decoration \rightarrow denoted cartesian edges in [HHLN23], with our conventions it is exactly the ingressive edges in Y which are all p -cartesian, and that the egressive edges are *almost never* all p -cartesian.

The naming schema above is inspired by the definitions of [HHLN23]. We will show in Section 6 that in the case $X = (A \times B, A \times \iota B, \iota A \times B)$, the definitions above reduce to the corresponding objects of [HHLN23].

Note that, on the one hand, $\text{Cart}_{\text{in}}(A, A, \iota A)$ is simply the ∞ -category of cartesian fibrations over A , as are the two subcategories CrvOrtho and OpGray in this case. On the other hand, $\text{Cart}_{\text{in}}(A, \iota A, A)$ is just Cat/A , while $\text{OpGray}(A, \iota A, A) = \text{Cart}(A)$ and $\text{CrvOrtho}(A, \iota A, A) = \text{Cocart}(A)$.

One can informally think about an op-Gray fibration over X as encoding a lax functor from X to Cat , which is strong on 2-simplices in X_{in} or X^{eg} , as well as 2-simplices of the form $x_0 \rightarrow x_1 \rightarrow x_2$. This is substantiated (using the scaled straightening construction of Lurie [Lu09b]) by the following observation:

Lemma 5.16. *An op-Gray fibration $p: Y \rightarrow X$ is, in particular, a locally cartesian fibration. Furthermore, for each 2-simplex $\sigma: [2] \rightarrow X$ arising from the composition of an ingressive and an egressive map $x_0 \rightarrow x_1 \rightarrow x_2$, the restriction $\sigma^*(p): \sigma^*Y \rightarrow [2]$ is a cartesian fibration.*

Proof. Note that the second part implies that p is a locally cartesian fibration since every morphism in X fits into a 2-simplex σ as indicated. To see that $\sigma^*(p)$ is a cartesian fibration, one simply notes that it admits enough cartesian lifts of $x_1 \rightarrow x_2$ (since p does) and locally cartesian lifts over $x_0 \rightarrow x_1$. \square

Lemma 5.17. *Let $p: Y \rightarrow X$ be an op-Gray fibration between orthogonal adequate triples. Then the following are equivalent:*

- (1) *The underlying functor $p: Y \rightarrow X$ is a cartesian fibration.*
- (2) *For every ambigressive square*

$$\begin{array}{ccc}
 y_{00} & \xrightarrow{\quad} & y_{01} \\
 f \downarrow & & \downarrow f' \\
 y_{10} & \xrightarrow{\quad} & y_{11}
 \end{array}
 \tag{5.18}$$

in which f' is p^{eg} -cartesian, f is p^{eg} -cartesian as well.

Proof. Assuming (1), the uniqueness of cartesian lifts implies that an egressive morphism in Y is p^{eg} -cartesian if and only if it is p -cartesian. Except for f' , all arrows in the square (5.18) are therefore p -cartesian, which implies that f' is p -cartesian as well.

For the converse, Lemma 5.16 already asserts that p is a locally cartesian fibration. It then suffices to verify that locally p -cartesian morphisms are closed under composition. To this end, let f and g be two composable locally p -cartesian morphisms in Y and consider the diagram

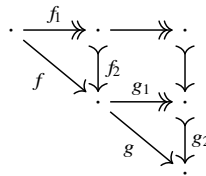

Here, the two triangles factor f and g into an egressive followed by an ingressive morphism; Lemma 5.16 shows that the maps f_1, f_2, g_1 and g_2 are all locally p -cartesian. The top right square is obtained by factoring the down-right composite into an egressive, followed by an ingressive map. Condition (2) then implies that all individual arrows depicted in the above picture are locally p -cartesian (and the horizontal ones are p -cartesian). Since p^{eg} was a cartesian fibration, the top composite is then locally p -cartesian, and since the right vertical composite is p -cartesian, the composite gf is locally p -cartesian as well. \square

Definition 5.19. We will say that a map $p: Y \rightarrow X$ of orthogonal adequate triples is a *cartesian fibration* if it is an op-Gray fibration satisfying the equivalent conditions of Lemma 5.17. Dually, a curved orthofibration is called an *orthofibration* if for each ambigressive square (5.18) in which f is p^{eg} -cocartesian, f' is p^{eg} -cocartesian as well.

Let us write $\text{Cart}(X) \subseteq \text{OpGray}(X)$ and $\text{Ortho}(X) \subseteq \text{CrvOrtho}(X)$ for the full subcategories on cartesian and orthofibrations; this notation is justified by the following observation:

Observation 5.20. Note that the datum of a cartesian fibration of orthogonal adequate triples $p: Y \rightarrow X$ is equivalent to that of a cartesian fibration between the underlying ∞ -categories. In addition, a map in $\text{Cart}(X)$ is required to preserve cartesian lifts over ingressive and egressive maps in X ; since every map in X factors into an egressive map followed by an ingressive one, it follows that the maps in $\text{Cart}(X)$ preserve all cartesian arrows. In other words, $\text{Cart}(X)$ is simply equivalent to the ∞ -category of cartesian fibrations over the underlying ∞ -category of X .

The main result about these various types of fibration is that they behave well under dualisation:

Theorem 5.21. *Let X be an orthogonal adequate triple. Then the natural equivalence*

$$\text{Span}^\perp : \text{AdTrip}^\perp / X \rightarrow \text{AdTrip}^\perp / \text{Span}^\perp(X)$$

restricts to natural equivalences

$$\begin{aligned}
 \text{Cart}_{\text{in}}(X) &\simeq \text{Cart}_{\text{in}}(\text{Span}^\perp(X)) \\
 \text{OpGray}(X) &\simeq \text{CrvOrtho}(\text{Span}^\perp(X)) \\
 \text{Cart}(X) &\simeq \text{Ortho}(\text{Span}^\perp(X)).
 \end{aligned}$$

Furthermore, for each fibration $p: Y \rightarrow X$, the dual fibration $\text{Span}^\perp(Y) \rightarrow \text{Span}^\perp(X)$ has fibres given by the opposites of the fibres of p .

In the simple case $X = (A, A, \iota A)$, this result specialises to the statement that taking span categories for the adequate triple structure given by the cartesian and fibrewise maps provides an equivalence

$$\text{Span: } \text{Cart}(A) = \text{Cart}_{\text{in}}(X) \rightarrow \text{Cart}_{\text{in}}(\text{Span}^\perp(X)) = \text{Cart}(A)$$

sending a cartesian fibration to the cartesian fibration with opposite fibres. Postcomposing with the equivalence $\text{Cart}(A) \simeq \text{Cocart}(A^{\text{op}})$ sending $Y \rightarrow A$ to $Y^{\text{op}} \rightarrow A^{\text{op}}$, we obtain the equivalence first established by Barwick, Glasman and Nardin [BGN18, Theorem 1.4]. Note that by Lemma 2.14, this composite equivalence coincides with the equivalence obtained by first exchanging the ingressive and egressive maps and then applying the equivalence from Corollary 3.18.

In the case $X = (A, \iota A, A)$, however, the result simply specialises to the equivalence

$$\text{Cat}/A = \text{Cart}_{\text{in}}(X) \rightarrow \text{Cart}_{\text{in}}(\text{Span}^\perp(X)) = \text{Cat}/A^{\text{op}},$$

given by taking opposites. In the case of a general X , our equivalence combines these two extremes, as we shall discuss in the case of two-variable fibrations from [HHLN23] in the next section.

Proof. Note that naturality of these equivalences follows directly from Span^\perp being a functor and taking over-categories being natural in the base.

Let us start with the first equivalence. Since Span^\perp is its own inverse, it suffices to verify that for an ingressive cartesian fibration $p: Y \rightarrow X$, the dual map $q = \text{Span}^\perp(p): \text{Span}^\perp(Y) \rightarrow \text{Span}^\perp(X)$ is an ingressive cartesian fibration. Recall that an ingressive map in $\text{Span}^\perp(Y)$ is given by a span $y_{11} \overset{\sim}{\leftarrow} y_{01} \rightrightarrows y_{00}$ in Y .

To see that q is an ingressive fibration, it suffices to verify that all such spans define q -cartesian edges in $\text{Span}(Y)$, since there are then clearly enough cartesian lifts of edges in X_{in} . Equivalently, this means that the reverse span $y_{00} \leftarrow y_{01} \overset{\sim}{\rightarrow} y_{11}$ defines a q^{op} -cocartesian arrow. We can identify the opposite map $q^{\text{op}}: \text{Span}(Y)^{\text{op}} \rightarrow \text{Span}(X)^{\text{op}}$ with $\text{Span}(p^{\text{rev}}): \text{Span}(Y^{\text{rev}}) \rightarrow \text{Span}(X^{\text{rev}})$ (that is, we exchange the roles of the ingressive and egressive maps). The reverse span is then $\text{Span}(p^{\text{rev}})$ -cocartesian by Corollary 3.2.

To see the second equivalence, we observe that given any $p: Y \rightarrow X$ in $\text{Cart}_{\text{in}}(X)$, the functor $q^{\text{eg}}: \text{Span}^\perp(Y)^{\text{eg}} \rightarrow \text{Span}^\perp(X)^{\text{eg}}$ is equivalent to the *opposite* of $p^{\text{eg}}: Y^{\text{eg}} \rightarrow X^{\text{eg}}$. This immediately implies that Span^\perp exchanges curved orthofibrations and op-Gray fibrations and furthermore preserves maps between them that preserve (co)cartesian ingressive arrows.

For the third equivalence, recall from Proposition 4.9 that an ambgressive square in $\text{Span}^\perp(Y)$ corresponds to a diagram of the form

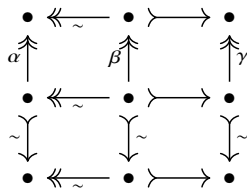

in Y . Suppose p is a cartesian fibration. The left span defines a q^{eg} -cocartesian arrow if and only if α is p^{eg} -cartesian. This immediately implies that β is also p^{eg} -cartesian. Finally, the top right square is cartesian, and therefore, we conclude by 5.17 that γ is also p^{eg} -cartesian, so that the right vertical span is q^{eg} -cartesian. This implies by definition that q is an orthofibration of orthogonal triples. A dual argument (again using 5.17) shows that the dual of an orthofibration is a cartesian fibration.

Finally, for the statement about fibres, note that Span^\perp (being an equivalence) preserves fibres (i.e., pullbacks along a map (of orthogonal adequate triples) $* \rightarrow X$). Observation 5.2 then implies that the fibre of $\text{Span}^\perp(Y) \rightarrow \text{Span}^\perp(X)$ over a point x is given by $\text{Span}^\perp(Y_x, \iota Y_x, Y_x)$, whose underlying category is equivalent to Y_x^{op} by Proposition 2.15. \square

6. Dualisation and straightening of two-variable fibrations

The purpose of this section is to use the results of the previous section to dualise and straighten various kinds of fibrations over a product of ∞ -categories. The first part essentially consists of specialising Theorem 5.21 to the case where X is the particular orthogonal triple

$$(A, B)^\perp := (A \times B, A \times \iota B, \iota A \times B)$$

associated to a product of two ∞ -categories. We will find that the various fibrations defined over $(A, B)^\perp$ in the previous section recover a subset of the fibrations which we considered in [HHLN23].

In particular, we will extend the explicit description of dual (co)cartesian fibrations to the situation of curved ortho- and Gray fibrations. As an application, we give an explicit description of parametrised adjoints from [HHLN23], extending previous work of Torii [To20].

Let us start by making the various types of fibrations of orthogonal adequate triples $p: Y \rightarrow (A, B)^\perp$ appearing in Section 5 more explicit. Recall that for all these fibrations, the structure of an adequate triple on Y is uniquely determined by the underlying functor (see Observation 5.2)

$$p = (p_1, p_2): Y \rightarrow A \times B.$$

By Proposition 4.4, such p determines an ingressive cartesian fibration if and only if all (ingressive) arrows in $A \times \iota B$ have enough cartesian lifts. By [HHLN23, Corollary 2.2.2] or [Lu09a, Proposition 2.4.1.3(3)], this is equivalent to

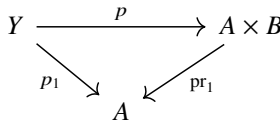

defining a map of cartesian fibrations over A preserving cartesian arrows. In particular, each $\alpha: a \rightarrow a'$ in A gives rise to a cartesian transport functor $\alpha^*: Y_{a'} \rightarrow Y_a$ between the fibres of p_1 . Following [HHLN23], let us write $\text{LCart}(A, B)$ for the ∞ -category of $p: Y \rightarrow A \times B$ having p -cartesian lifts over $A \times \iota B$ and maps preserving such p -cartesian lifts. In these terms, we have the following:

Observation 6.1. There are natural equivalences of ∞ -categories

$$\text{Cart}_{\text{in}}((A, B)^\perp) \simeq \text{LCart}(A, B).$$

Remark 6.2. There is an evident analogue $\text{LCocart}(A, B)$ consisting of $p: Y \rightarrow A \times B$ having p -cocartesian lifts over $A \times \iota B$. This ∞ -category does not have a good interpretation in terms of adequate triples; one can typically not equip Y with the natural structure of an adequate triple.

Lemma 6.3. Let $p = (p_1, p_2): Y \rightarrow A \times B$ be a map in $\text{LCart}(A, B)$. Then p defines the following:

- (1) an op-Gray fibration in the sense of Definition 5.14 if and only if for each $a \in A$, the map $p_2: Y_a \rightarrow Y \rightarrow B$ from the fibre of p_1 is a cartesian fibration.
- (2) a curved orthofibration in the sense of Definition 5.14 if and only if for each $a \in A$, the map $p_2: Y_a \rightarrow Y \rightarrow B$ from the fibre of p_1 is a cocartesian fibration.

Proof. Observe that the map $Y^{\text{eg}} \rightarrow ((A, B)^\perp)^{\text{eg}}$ is simply given by the restriction of $p: Y \rightarrow A \times B$ to $\iota A \times B$. It follows from [HHLN23, Remark 2.2.9] that this restriction to $\iota A \times B$ is a (co)cartesian fibration if and only if for each $a \in A$, the restriction $p_a: Y_a \rightarrow \{a\} \times B$ of p is a (co)cartesian fibration. Finally, note that p_a can be identified with p_2 (restricted to the fibre Y_a). □

Definition 6.4. Let us denote by $\text{CrvOrtho}(A, B)$ the subcategory of $\text{Cat}/A \times B$ whose objects are curved orthofibrations and whose morphisms are maps preserving locally p -cartesian morphisms over $A \times \iota B$ and locally p -cocartesian morphisms over $\iota A \times B$. We define $\text{OpGray}(A, B)$ similarly.

We then immediately find the following:

Corollary 6.5. *There are natural equivalences*

$$\begin{aligned} \text{CrvOrtho}((A, B)^\perp) &\xrightarrow{\sim} \text{CrvOrtho}(A, B) \\ \text{OpGray}((A, B)^\perp) &\xrightarrow{\sim} \text{OpGray}(A, B). \end{aligned}$$

Remark 6.6. As one may expect, the notion of a *Gray fibration* $p: Y \rightarrow A \times B$ was introduced in [HHLN23] as the opposite of an op-Gray fibration; that is, there is an equivalence

$$(-)^{\text{op}}: \text{Gray}(A, B) \xrightarrow{\sim} \text{OpGray}(A^{\text{op}}, B^{\text{op}}).$$

In particular, $\text{Gray}(A, B)$ is a certain subcategory of $\text{LCocart}(A, B)$. As in Remark 6.2, it does not have a good analogue for general orthogonal adequate triples.

Remark 6.7. In [HHLN23, Section 2], we recorded various other ways to recognise (op-)Gray fibrations and curved orthofibrations. For example, $(p_1, p_2): Y \rightarrow A \times B$ is a curved orthofibration if p_1 is a cartesian fibration and p_2 is a cocartesian fibration [HHLN23, Proposition 2.3.3]; that is,

$$\text{CrvOrtho}(A, B) = \text{LCart}(A, B) \cap \text{RCocart}(A, B).$$

Lemma 6.8. *A map $p = (p_1, p_2): Y \rightarrow A \times B$ is an orthofibration in the sense of Definition 5.19 if and only if it is a curved orthofibration and for each map $\alpha: a \rightarrow a'$, the cartesian transport functor $\alpha^*: Y_{a'} \rightarrow Y_a$ preserves p_2 -cocartesian arrows.*

Proof. Let us start by noting that an arrow in some fibre $Y_a \subseteq Y$ is p_2 -cocartesian if and only if it defines a cocartesian arrow for the base change of p to $\iota A \times B$; see [HHLN23, Corollary 2.2.7]. This base change coincides with $p^{\text{eg}}: Y^{\text{eg}} \rightarrow ((A \times B)^\perp)^{\text{eg}}$, so an arrow in Y_a is p_2 -cocartesian if and only if it defines a p^{eg} -cocartesian arrow.

Using this, it follows that α^* preserves p_2 -cocartesian arrows if and only if the following holds: for each square in Y

$$\begin{array}{ccc} y_{a,b} & \longrightarrow & y_{a',b} \\ \downarrow & & \downarrow \\ y_{a,b'} & \longrightarrow & y_{a',b'} \end{array} \quad \longmapsto \quad \begin{array}{ccc} (a, b) & \xrightarrow{\alpha} & (a', b) \\ \beta \downarrow & & \downarrow \beta \\ (a, b') & \xrightarrow{\alpha} & (a', b') \end{array}$$

in which the vertical arrows are p -cartesian and the bottom horizontal arrow is p_{in} -cocartesian, the top horizontal arrow is p_2 -cocartesian. This is precisely the condition of Definition 5.19, since the ambigressive squares in Y are precisely squares of the above form whose vertical maps are p -cartesian. □

Lemma 6.8 asserts that the notion of an orthofibration as defined in Definition 5.19 agrees (over $X = A \times B$) with the notion of an orthofibration employed in [HHLN23] (see, in particular, [HHLN23, Proposition 2.3.11]). Writing $\text{Ortho}(A, B) \subseteq \text{CrvOrtho}(A, B)$ for the full subcategory spanned by the orthofibrations, we therefore obtain the following:

Corollary 6.9. *There are natural equivalences of ∞ -categories*

$$\text{Ortho}((A, B)^\perp) \simeq \text{Ortho}(A, B).$$

All in all, we have found that over the orthogonal triple $(A, B)^\perp = (A \times B, A \times \iota B, \iota A \times B)$, the ∞ -categories of fibrations introduced in Section 5 coincide with those appearing under the same name in [HHLN23].

We will now unravel the content of the dualisation equivalence from Theorem 5.21 over the base $X = (A, B)^\perp$. To this end, let us start with the following observation:

Lemma 6.10. *Let A and B be two ∞ -categories. Then there is an equivalence of orthogonal adequate triples*

$$\text{Span}^\perp((A, B)^\perp) \simeq (A, B^{\text{op}})^\perp.$$

Proof. Note that $(A, B)^\perp$ decomposes as a product of the triples $(A, A, \iota A)$ and $(B, \iota B, B)$, both of which are evidently orthogonal and adequate (and both these properties are preserved under taking products). Since the span construction preserves products, being a right adjoint, the claim follows from Proposition 2.15. \square

Consequently, Theorem 5.21 provides equivalences between certain types of fibrations over $A \times B$ and $A \times B^{\text{op}}$, respectively. Recall from Theorem 5.21 that these equivalences take opposite categories at the level of fibres. To conform with the conventions of [HHLN23], we will therefore compose the equivalences of Theorem 5.21 with taking opposites, resulting in the following:

Definition 6.11. For ∞ -categories A and B , we define functors

$$\begin{aligned} \text{SD}^{\text{cc}} &: \text{LCart}(A, B) \xrightarrow{\text{Span}^\perp} \text{LCart}(A, B^{\text{op}}) \xrightarrow{(-)^{\text{op}}} \text{LCocart}(A^{\text{op}}, B) \\ \text{SD}^{\text{ct}} &: \text{LCocart}(A^{\text{op}}, B) \xrightarrow{(-)^{\text{op}}} \text{LCart}(A, B^{\text{op}}) \xrightarrow{\text{Span}^\perp} \text{LCart}(A, B) \end{aligned}$$

using the identifications from Observation 6.1 and Lemma 6.10.

Using Theorem 5.21 and the identifications Corollary 6.5 from Corollary 6.9, we then immediately find the following:

Corollary 6.12. *The functor $\text{SD}^{\text{cc}}: \text{LCart}(A, B) \rightarrow \text{LCocart}(A^{\text{op}}, B)$ is an equivalence with inverse SD^{ct} and restricts to equivalences*

$$\text{CrvOrtho}(A, B) \xrightarrow{\sim} \text{Gray}(A^{\text{op}}, B) \quad \text{and} \quad \text{Ortho}(A, B) \xrightarrow{\sim} \text{Cocart}(A^{\text{op}} \times B)$$

natural in $A, B \in \text{Cat}$. For $A = *$, and thus in particular on fibres, this equivalence restricts to the identity.

Remark 6.13. For a map $p: Y \rightarrow A \times B$ in $\text{LCart}(A, B)$, the dual fibration $\text{SD}^{\text{cc}}(p): \text{SD}^{\text{cc}}(Y) \rightarrow A^{\text{op}} \times B$ is given explicitly as follows. The objects of $\text{SD}^{\text{cc}}(Y)$ are the same as those of Y , and a morphism from y to y' is given by a span

$$\begin{array}{ccc} & z & \\ y & \swarrow \quad \searrow & y' \end{array} \xrightarrow{p} \begin{array}{ccc} & (a, b) & \\ (a', b) & \swarrow \quad \searrow & (a, b') \end{array}$$

(g, id) above (a', b) , (id, f) above (a, b')

where the left map $z \rightarrow y$ is p -cartesian. Dually, for a map $q: X \rightarrow A \times B$ in $\text{LCocart}(A, B)$, we find $\text{SD}^{\text{ct}}(Y) \rightarrow A^{\text{op}} \times B$ has morphisms from y to y' given by diagrams

$$\begin{array}{ccc} & z & \\ y & \nearrow \quad \nwarrow & y' \end{array} \xrightarrow{q} \begin{array}{ccc} & (a', b') & \\ (a', b) & \nearrow \quad \nwarrow & (a, b') \end{array}$$

(id, f) above (a', b) , (g, id) above (a, b')

where the right map $y' \rightarrow z$ is q -cocartesian.

Taking $B = *$, Corollary 6.12 reproduces the dualisation equivalence between cartesian fibrations over A and cocartesian fibrations over A^{op} from [BGN18], which their main result shows is equivalent (naturally in A and B) to

$$\text{Cart}(A) \xrightarrow{\text{Str}^{ct}} \text{Fun}(A^{op}, \text{Cat}) \xrightarrow{\text{Un}^{cc}} \text{Cocart}(A^{op});$$

we gave a more direct proof of this fact as Theorem 3.18 above (it also follows from the unicity results from Appendix A). In [HHLN23, Section 2.5], we extended this procedure to an equivalence

$$\text{D}^{cc} : \text{LCart}(A, B) \xrightarrow{\text{Str}^{ct}} \text{Fun}(A^{op}, \text{Cat}/B) \xrightarrow{\text{Un}^{cc}} \text{LCocart}(A^{op}, B) : \text{D}^{ct}$$

by straightening in one variable. We deduce the following:

Corollary 6.14. *The functors*

$$\text{SD}^{cc} : \text{LCart}(A, B) \rightleftarrows \text{LCocart}(A^{op}, B) : \text{SD}^{ct}$$

agree with the equivalences D^{cc} and D^{ct} constructed in [HHLN23, Section 2.5].

Proof. Essentially by construction, the two diagrams

$$\begin{array}{ccc} \text{LCart}(A, B) & \xrightarrow{\text{SD}^{cc}} & \text{LCocart}(A^{op}, B) \\ \text{fgt} \uparrow & & \uparrow \text{fgt} \\ \text{Cart}(A)/\text{pr}_1 & \xrightarrow{\text{SD}^{cc}} & \text{Cocart}(A^{op})/\text{pr}_1 \end{array} \qquad \begin{array}{ccc} \text{LCart}(A, B) & \xrightarrow{\text{D}^{cc}} & \text{LCocart}(A^{op}, B) \\ \text{fgt} \uparrow & & \uparrow \text{fgt} \\ \text{Cart}(A)/\text{pr}_1 & \xrightarrow{\text{D}^{cc}} & \text{Cocart}(A^{op})/\text{pr}_1 \end{array}$$

commute naturally in A and B . Here, the bottom copy of SD^{cc} arises from Definition 6.11 by taking $B = *$. Since the vertical maps are equivalences, the agreement of the two functors in the one-variable case implies that in the two-variable case. \square

Example 6.15. As an example, consider the dual of the bifibration $(s, t) : \text{Ar}(X) \rightarrow X \times X$; see [Lu09a, Corollary 2.4.7.11], which, in particular, defines an object in $\text{Ortho}(X, X)$. We claim that the functor from Definition 6.11 sends this to

$$(\text{Tw}^\ell(X) \rightarrow X^{op} \times X) \simeq \text{SD}^{cc}(\text{Ar}(X) \rightarrow X^2).$$

Let us mention that an analogous identification

$$(\text{Tw}^\ell(X) \rightarrow X^{op} \times X) \simeq \text{D}^{cc}(\text{Ar}(X) \rightarrow X^2)$$

is a direct consequence of [HMS22, Corollary A.2.5], the argument of which is based on the universal property of twisted arrow ∞ -categories from [Lu17, Corollary 5.2.1.22]. In the (current) absence of a similar universal property for twisted arrow ∞ -categories of $(\infty, 2)$ -categories, such a proof does not generalise to this more general situation. The present example should be considered a warm-up for Section 7 below, where we provide this extension using the span model for dual fibrations.

Now for the proof: Unravelling the definitions, we find that SD^{cc} is given by the opposite of the associated ∞ -category of a certain simplicial ∞ -groupoid Φ , where Φ_n is given by the ∞ -groupoid of diagrams $\phi : \text{Tw}^r([n]) \times [1] \rightarrow X$ that take edges in $\text{Tw}^r([n])^{\text{eg}} \times \{0\}$ and $\text{Tw}^r([n])_{\text{in}} \times \{1\}$ to equivalences. We now claim that the localisation of $\text{Tw}^r([n]) \times [1]$ at these subcategories is naturally equivalent to $[n] \star [n]^{op}$ via the map

$$\text{Tw}^r([n]) \times [1] \rightarrow [n] \star [n]^{op}, \quad ((i \leq j), \epsilon) \mapsto \begin{cases} i_l & \epsilon = 0 \\ j_r & \epsilon = 1 \end{cases}, \quad (*)$$

where we have used subscripts to indicate join factors. Restriction along this map then shows that $\text{ac}(\Phi) \simeq \text{Tw}^r(X)$, and so $\text{ac}(\Phi)^{\text{op}} \simeq \text{Tw}^l(X)$, as required. One can also check that this equivalence lives over $X^{\text{op}} \times X$.

To see the claim, we note that both restrictions $\text{Tw}^r([n]) \times \{\epsilon\} \rightarrow X$ of a diagram ϕ as considered above take all squares in $\text{Tw}^r([n])$ to pushout squares in X (namely, ones in which two opposite edges are equivalences). Using the pointwise formula for left Kan extensions, one readily checks that $\phi: \text{Tw}^r([n]) \times [1] \rightarrow X$ is then left Kan extended from the subposet $\mathcal{J}_n \times [1]$, where \mathcal{J}_n is the arch along the top of $\text{Tw}^r([n])$ consisting of all $(i \leq j)$ with $i = 0$ or $j = n$. It follows that the inclusion $\mathcal{J}_n \times [1] \rightarrow \text{Tw}^r([n]) \times [1]$ induces an equivalence upon localisation.

Now note that \mathcal{J}_n consists of two copies of $[n]$ glued along the initial vertex. The claim then follows from the fact that the localisation of $[n] \times [1]$ at $[n] \times \{1\}$ is given by $[n + 1]$ and likewise for the localisation at $[n] \times \{0\}$; this realises the localisation of \mathcal{J}_n as the pushout of $[n + 1]$ and $[1 + n]$ along $[1]$, embedded into the former as the terminal segment, and into the latter as the initial one. Finally, observe that the localisation map $\mathcal{J}_n \times [1] \rightarrow [n + 1] \cup_{[1]} [1 + n] \cong [n] \star [n]^{\text{op}}$ just described is indeed the restriction of $(*)$.

We can also use the identification of D^{cc} and the functor SD^{cc} from Definition 6.11 to describe the fibrewise adjoints constructed in [HHLN23, Section 3.1] more explicitly. For this, we need to recall some notation from [HHLN23, Section 3]. Fix a parametrised left adjoint

$$\begin{array}{ccc} D & \xrightarrow{L} & C \\ & \searrow p & \swarrow q \\ & & B, \end{array}$$

(i.e., a map between two cartesian fibrations (though not necessarily preserving cartesian edges)) such that the restrictions $L_b: D_b \rightarrow C_b$ to the fibres admit right adjoints $R_b: C_b \rightarrow D_b$. In [HHLN23], we constructed from this data a diagram

$$\begin{array}{ccc} \text{D}^{\text{cc}}(p) & \xleftarrow{R} & \text{D}^{\text{cc}}(q) \\ & \searrow & \swarrow \\ & & B^{\text{op}}, \end{array}$$

such that R restricts to the functors R_b under the identifications $\text{D}^{\text{cc}}(p)_b \simeq D_p$ and $\text{D}^{\text{cc}}(q)_b \simeq C_b$ arising from the naturality of D^{cc} and showed that this gives an equivalence between the $(\infty, 2)$ -category of parametrised left adjoints and that of parametrised right adjoints (after taking opposites appropriately). One can use the equivalence $\text{SD}^{\text{cc}} \simeq \text{D}^{\text{cc}}$ to give an explicit description of the functor R ; see also [To20, Section 3.1] for a point-set variant of this construction of fibrewise adjoints.

To formulate the statement, observe that for each $\beta: b' \rightarrow b$, the left adjoints L_b and L'_b and the cartesian transport functors of p and q are related by a natural transformation $\lambda_\beta: L_b \beta^* \rightarrow \beta^* L_b$. We then have the following:

Proposition 6.16. *For a parametrised left adjoint L , the associated parametrised right adjoint*

$$\begin{array}{ccc} \text{SD}^{\text{cc}}(p) & \xleftarrow{R} & \text{SD}^{\text{cc}}(q) \\ & \searrow & \swarrow \\ & & B^{\text{op}}, \end{array}$$

can be described as follows:

- For an object y_b in the fibre $\text{SD}^{\text{cc}}(q)_b \simeq C_b$ over $b \in B$, one has $R(y_b) \simeq R_b(y_b)$.
- For a map $\beta: b' \rightarrow b$ in B , the functor R is given on morphisms over β^{op} in $\text{SD}^{\text{cc}}(q)$ by

$$\begin{array}{ccc}
 \beta^* x_b & \xrightarrow{f} & y_{b'} \\
 \llcorner & & \lrcorner \\
 x_b & &
 \end{array}
 \quad \longmapsto \quad
 \begin{array}{ccc}
 \beta^* R_b(x_b) & \xrightarrow{g} & R_{b'}(y_{b'}) \\
 \llcorner & & \lrcorner \\
 R_b(x_b) & &
 \end{array}$$

Here, the left-pointing arrows are cartesian lifts of β in C and D , and the right-pointing arrows are fibrewise over b' , with g given by the (fibrewise) adjoint to

$$L_{b'} \beta^* R_b(x_b) \xrightarrow{\lambda_\beta} \beta^* L_b R_b(x_b) \xrightarrow{\epsilon} \beta^* x_b \xrightarrow{f} y_{b'}. \tag{6.17}$$

Proof. A direct construction of R can be carried out exactly as in [HHLN23, Theorem 3.1.11], so we will be brief. Applying cocartesian unstraightening to the functor L yields a curved orthofibration $\pi: X \rightarrow B \times [1]$. Since L admits fibrewise right adjoints, this map is an op-Gray fibration as well. Applying the span dualisation from Corollary 6.12 to this op-Gray fibration yields a curved orthofibration $\text{SD}^{\text{ct}}(\pi): \text{SD}^{\text{ct}}(X) \rightarrow [1] \times B^{\text{op}}$, which can be straightened over $[1]$ to yield the desired functor R .

Let us now describe the behaviour of R on arrows (and hence also on objects). Note that the functor R arises from cartesian transport in $\text{SD}^{\text{ct}}(\pi): \text{SD}^{\text{ct}}(X) \rightarrow [1] \times B^{\text{op}}$ in the direction of $[1]$. Consequently, it suffices to understand those squares in $\text{SD}^{\text{ct}}(\pi)$ whose vertical maps are cartesian lifts of the map in $[1]$ and whose horizontal maps cover an arrow β^{op} in B^{op} . Like in the proof of Theorem 5.21, unraveling the definitions shows that such a square in $\text{SD}^{\text{ct}}(X)$ corresponds to a diagram in the domain of $\pi: X \rightarrow B \times [1]$ of the form

$$\begin{array}{ccc}
 R_b(x) \llcorner \beta^* R_b(x) \xrightarrow{g} R_{b'}(y) & & (b, 0) \xleftarrow{\beta} (b', 0) \longrightarrow (b', 0) \\
 \sim \uparrow & & \uparrow & & \uparrow \\
 R_b(x) \llcorner \beta^* R_b(x) \xrightarrow{g} R_{b'}(y) & \longmapsto & (b, 0) \xleftarrow{\beta} (b', 0) \longrightarrow (b', 0) \\
 \downarrow & & \downarrow & & \downarrow \\
 x \llcorner \beta^* x \xrightarrow{f} y & & (b, 1) \xleftarrow{\beta} (b', 1) \longrightarrow (b', 1)
 \end{array}$$

where the top right and bottom left squares are (cartesian) ambigressive in X . In particular, the left-pointing arrows are all π -cartesian lifts of β . Let us explain the rest of the diagram in more detail. For the left and right vertical spans to describe cartesian arrows in $\text{SD}^{\text{ct}}(X)$, one needs their upwards-pointing leg to be an equivalence (as indicated) and their downwards-pointing leg to define a cartesian arrow for the map $\pi_b: X_b \rightarrow \{b\} \times [1]$. Because each π_b is both a cocartesian and a cartesian fibration classifying the adjoint pair (L_b, R_b) , the objects in the middle row are then given by $R_b(x), \beta^* R_b(x)$ and $R_{b'}(y)$. Finally, the right vertical square is entirely contained in the fibre $X_{b'}$. Since $R_{b'}(y) \rightarrow y$ was $\pi_{b'}$ -cartesian, the map g is therefore the *unique* one making the square commute.

It now remains to verify that we can indeed take g to be the adjoint to (6.17). This follows from an analysis very similar to [HHLN23, Proposition 3.2.7]. In fact, when f is the identity, the adjoint to (6.17) is precisely the *mate* of λ_β ; In this case, [HHLN23, Proposition 3.2.7] precisely asserts that the mate makes the bottom right square commute. \square

Finally, we will use Corollary 6.12 to identify various ways of straightening orthofibrations.

Proposition 6.18. *The four equivalences given by*

$$\begin{aligned} \text{Ortho}(A, B) &\xrightarrow{D^{\text{cc}}} \text{Cocart}(A^{\text{op}} \times B) \xrightarrow{\text{Str}^{\text{cc}}} \text{Fun}(A^{\text{op}} \times B, \text{Cat}) \\ \text{Ortho}(A, B) &\xrightarrow{D^{\text{ct}}} \text{Cart}(A \times B^{\text{op}}) \xrightarrow{\text{Str}^{\text{ct}}} \text{Fun}(A^{\text{op}} \times B, \text{Cat}) \\ \text{Ortho}(A, B) &\xrightarrow{\text{Str}^{\text{ct}}} \text{Fun}(A^{\text{op}}, \text{Cocart}(B)) \xrightarrow{\text{Str}^{\text{cc}}} \text{Fun}(A^{\text{op}} \times B, \text{Cat}) \end{aligned}$$

and

$$\text{Ortho}(A, B) \xrightarrow{\text{Str}^{\text{cc}}} \text{Fun}(B, \text{Cart}(A)) \xrightarrow{\text{Str}^{\text{ct}}} \text{Fun}(A^{\text{op}} \times B, \text{Cat})$$

are pairwise equivalent, naturally in $A, B \in \text{Cat}$.

Definition 6.19. We shall refer to any of the functors above as the *orthocartesian (un)straightening equivalence*, in formulae

$$\text{Str}^{\text{oc}} : \text{Ortho}(A, B) \rightleftarrows \text{Fun}(A^{\text{op}} \times B, \text{Cat}) : \text{Un}^{\text{oc}}.$$

For example, we learn from Example 6.15 that

$$\text{Str}^{\text{oc}}((s, t) : \text{Ar}(C) \rightarrow C \times C) \simeq (\text{Hom}_C : C^{\text{op}} \times C \rightarrow \text{Gpd}),$$

which we will generalise to (op)lax arrow categories of $(\infty, 2)$ -categories in the next section.

We shall give a fairly direct comparison between the four equivalences above in the present section, but there could be more ways of straightening an orthofibration. For example, in [St18], Stevenson produced an equivalence

$$\text{Bifib}(A, B) \simeq \text{Fun}(A^{\text{op}} \times B, \text{Gpd})$$

by comparing both sides to a model category of correspondences. In order to settle such coherence questions once and for all, we take another cue from [BGN18] and show in the appendix that *any* equivalence as in the statement of Proposition 6.18 that is natural in the input categories and restricts to the identity for $A = * = B$ agrees with that above (in an essentially unique fashion). We also include similar statements for curved orthofibrations and bifibrations, in particular settling the comparison with Stevenson’s construction.

For the direct proof (and also the naturality of the Yoneda embedding), we need the following:

Lemma 6.20. *The three functors*

$$\begin{aligned} \text{Cocart}(A \times B) &\xrightarrow{\text{Str}_{A \times B}^{\text{cc}}} \text{Fun}(A \times B, \text{Cat}) \\ \text{Cocart}(A \times B) &\xrightarrow{\text{Str}_A^{\text{cc}}} \text{Fun}(A, \text{Cocart}(B)) \xrightarrow{\text{Str}_B^{\text{cc}}} \text{Fun}(A \times B, \text{Cat}) \\ \text{Cocart}(A \times B) &\xrightarrow{\text{Str}_B^{\text{cc}}} \text{Fun}(B, \text{Cocart}(A)) \xrightarrow{\text{Str}_A^{\text{cc}}} \text{Fun}(A \times B, \text{Cat}) \end{aligned}$$

are pairwise equivalent.

Proof. We again use the formula

$$\text{Un}^{\text{cc}}(F) \simeq \text{colim} \left(\Phi_F : \text{Tw}^r(A \times B) \xrightarrow{(s,t)} (A \times B) \times (A \times B)^{\text{op}} \xrightarrow{F \times (A \times B)_-} \text{Cat} \right)$$

from [GHN17]. Using $\text{Tw}^r(A \times B) = \text{Tw}^r(A) \times \text{Tw}^r(B)$ and $(A \times B)_{-/} = A_{-/} \times B_{-/}$ and the fact that colimits over a product can (naturally in the indexing categories) be computed in two steps, we find that this colimit agrees with that of

$$\text{Tw}^r(B) \longrightarrow \text{Fun}(\text{Tw}^r(A), \text{Cat}) \xrightarrow{\text{colim}} \text{Cat},$$

where the first functor is curried from Φ_F ; that is, it takes $f : x \rightarrow y \in \text{Tw}^r(B)$ to

$$\text{Tw}^r(A) \xrightarrow{(s,t)} A \times A^{\text{op}} \xrightarrow{F(-,x) \times A_{-/} \times B_{y/}} \text{Cat}.$$

But the colimit of this functor is naturally equivalent to the unstraightening of $F(-, x) \times B_{y/} : A \rightarrow \text{Cat}$, so in total, $\text{Un}^{\text{cc}}(F)$ is naturally identified with

$$\text{colim} \left(\text{Tw}^r(B) \longrightarrow B \times B^{\text{op}} \xrightarrow{\text{Un}_A^{\text{cc}}(F) \times B_{-/}} \text{Cat} \right),$$

which is itself unstraightening over B ; here, we regard Un_A^{cc} as the functor

$$\text{Fun}(A \times B, \text{Cat}) \longrightarrow \text{Fun}(B, \text{Cocart}(A)) \longrightarrow \text{Fun}(B, \text{Cat})/\text{cst}_A$$

by forgetting the map to A . In total, this process identifies

$$\text{Un}_{A \times B}^{\text{cc}} : \text{Fun}(A \times B, \text{Cat}) \longrightarrow \text{Cocart}(A \times B)$$

as the composite

$$\text{Fun}(A \times B, \text{Cat}) \xrightarrow{\text{Un}_A^{\text{cc}}} \text{Fun}(B, \text{Cocart}(A)) \xrightarrow{\text{Un}_B^{\text{cc}}} \text{Cocart}(A \times B)$$

as desired. □

Proof of Proposition 6.18. Recall that D^{cc} is defined as the composite

$$\text{Ortho}(A, B) \xrightarrow{\text{Str}^{\text{ct}}} \text{Fun}(A^{\text{op}}, \text{Cocart}(B)) \xrightarrow{\text{Un}^{\text{cc}}} \text{Cocart}(A^{\text{op}} \times B).$$

Thus, Lemma 6.20 immediately identifies the functors

$$\text{Ortho}(A, B) \xrightarrow{\text{D}^{\text{cc}}} \text{Cocart}(A^{\text{op}} \times B) \xrightarrow{\text{Str}^{\text{cc}}} \text{Fun}(A^{\text{op}} \times B, \text{Cat})$$

and

$$\text{Ortho}(A, B) \xrightarrow{\text{Str}^{\text{ct}}} \text{Fun}(A^{\text{op}}, \text{Cocart}(B)) \xrightarrow{\text{Str}^{\text{cc}}} \text{Fun}(A^{\text{op}} \times B, \text{Cat}),$$

and the argument for the first and fourth functors is dual. To compare the first composite with

$$\text{Ortho}(A, B) \xrightarrow{\text{D}^{\text{ct}}} \text{Cart}(A \times B^{\text{op}}) \xrightarrow{\text{Str}^{\text{ct}}} \text{Fun}(A^{\text{op}} \times B, \text{Cat}),$$

we observe that the diagram

$$\begin{array}{ccc} \text{Cocart}(A^{\text{op}} \times B) & \xrightarrow{\text{SD}^{\text{ct}}} & \text{Cart}(A \times B^{\text{op}}) \\ & \searrow \text{SD}^{\text{ct}} & \nearrow \text{SD}^{\text{ct}} \\ & \text{Ortho}(A, B) & \end{array}$$

commutes essentially by construction (whereas this does not seem clear from the construction for D^{ct}). It now follows from Corollary 6.14 that $D^{cc}: \text{Ortho}(A, B) \rightarrow \text{Cocart}(A^{op} \times B)$ agrees with

$$\text{Ortho}(A, B) \xrightarrow{D^{ct}} \text{Cart}(A \times B^{op}) \xrightarrow{D^{cc}} \text{Cocart}(A^{op} \times B),$$

whence the result follows from Corollary 3.18. □

Remark 6.21.

- (1) Straightening of bifibrations is also discussed in detail in [HLAS16, Section 5], [HMS22, Appendix A] and [CDH+23, Section 7.1], in each case by choosing one of the last two equivalences from 6.18 as the definition. For example, the stable ∞ -category underlying the Poincaré ∞ -category $\text{Pair}(\mathcal{C}, \mathcal{Q})$ from [CDH+23, Section 7.3] is simply the orthocartesian unstraightening of $\Omega^\infty B_{\mathcal{Q}}: \mathcal{C}^{op} \times \mathcal{C}^{op} \rightarrow \text{Gpd}$ in the language of the present paper.
- (2) The equivalence

$$\text{Gray}(A, B) \simeq \text{Fun}(A \boxtimes B, \text{Cat})$$

constructed in [HHLN23, Section 5.2] by definition restricts to the composite

$$\text{Cocart}(A \times B) \xrightarrow{\text{Str}^{cc}} \text{Fun}(A, \text{Cocart}(B)) \xrightarrow{\text{Str}^{cc}} \text{Fun}(A \times B, \text{Cat});$$

see [HHLN23, Remark 5.2.10]. As another consequence of (the dual of) Corollary 6.20, we obtain that our straightening equivalence for Gray fibrations extends the usual one for cocartesian fibrations over $A \times B$.

7. (Op)lax arrow and twisted arrow ∞ -categories

In this section, we will discuss an application of the dualisation procedure from Corollary 6.12 which extends Example 6.15. The duality between the arrow and twisted arrow category of an ∞ -category X extends to a duality between the oplax arrow and twisted arrow category of an $(\infty, 2)$ -category \mathbf{X} . More precisely, the oplax twisted arrow category of \mathbf{X}

$$(s, t): \text{Tw}^r(\mathbf{X}) \longrightarrow X \times X^{op}$$

is introduced in work of Abellán García and Stern [AGS23] as an explicit model for the cartesian fibration classified by the enriched mapping functor of \mathbf{X} (restricted to its underlying $(\infty, 1)$ -category X)

$$\text{Hom}_{\mathbf{X}}: X^{op} \times X \longrightarrow \text{Cat}.$$

We will show that the enriched mapping functor also classifies the orthofibration

$$(s, t): \text{Ar}^{opl}(\mathbf{X}) \longrightarrow X \times X$$

from the $(\infty, 1)$ -category underlying the oplax arrow category, defined using the (a priori unrelated) Gray tensor product of Gagna, Harpaz and Lanari from [GHL21].

Since the oplax twisted arrow category and the Gray tensor product are both defined using the model for $(\infty, 2)$ -categories given by scaled simplicial sets [Lu09b], we will start with a minimalistic review of these.

Notation 7.1. Recall that a scaled simplicial set is a pair (\mathbf{X}, S) consisting of a simplicial set \mathbf{X} and a subset $S \subseteq \mathbf{X}_2$ of 2-simplices that are called *thin*. The category sSet^{sc} of scaled simplicial sets carries a model structure in which the cofibrations are the monomorphisms, which is related to the model category $\text{Cat}(\text{sSet}^+)$ of categories enriched in marked simplicial sets (with the categorical model structure) by a

Quillen equivalence $\mathfrak{C}^{\text{sc}} : \text{sSet}^{\text{sc}} \rightleftarrows \text{Cat}(\text{sSet}^+) : \mathbb{N}^{\text{sc}}$ [Lu09b, Theorem 4.2.7]. We define the ∞ -category Cat_2 of $(\infty, 2)$ -categories as the ∞ -category associated to any of these two Quillen equivalent model categories (or any of the other standard models, cf. [Lu09b, Theorem 0.0.3]).

Notation 7.2. For a simplicial set X , we write X^\sharp for the associated scaled simplicial set in which every 2-simplex is thin. This determines a left Quillen functor $(-)^{\sharp} : \text{sSet} \rightarrow \text{sSet}^{\text{sc}}$, where sSet is equipped with the Joyal model structure. Its right adjoint sends a scaled simplicial set $(\mathbf{X}, \mathcal{S})$ to the sub-simplicial set of X spanned by the thin 2-simplices. At the level of ∞ -categories, this induces the fully faithful inclusion $\text{Cat} \hookrightarrow \text{Cat}_2$ of $(\infty, 1)$ -categories into $(\infty, 2)$ -categories, together with its right adjoint sending an $(\infty, 2)$ -category \mathbf{X} to its underlying $(\infty, 1)$ -category X .

To manipulate simple diagrams in $(\infty, 2)$ -categories, such as lax commuting squares and triangles, let us recall from [BSP21] that a *gaunt 2-category* is a strict 2-category whose only invertible 1- and 2-cells are the identities. For example, a gaunt 1-category A gives rise to a gaunt 2-category $[1]_A$ with

$$\text{Hom}_{[1]_A}(0, 1) = A, \quad \text{Hom}_{[1]_A}(1, 0) = \emptyset, \quad \text{and} \quad \text{Hom}_{[1]_A}(i, i) = *.$$

Every gaunt 2-category determines an object in $\text{Cat}(\text{sSet}^+)$ by taking the nerves of its mapping categories (with degenerate marking), and this determines a fully faithful functor $\text{Gaunt}_2 \hookrightarrow \text{Cat}_2$ from the (ordinary) category of gaunt 2-categories into the ∞ -category of $(\infty, 2)$ -categories, with essential image given by the 0-truncated objects [BSP21, Corollary 12.3]. To decompose diagrams indexed by gaunt 2-categories into simpler ones, let us record the following:

Proposition 7.3. *The inclusion $\text{Gaunt}_2 \hookrightarrow \text{Cat}_2$ preserves coproducts and the following pushouts:*

- (1) *Pushouts of the form $[1]_A \leftarrow \{i\} \xrightarrow{x} \mathbf{X}$ for $i = 0, 1$.*
- (2) *Pushouts of the form $[2] \xleftarrow{\partial^1} [1] \xrightarrow{\gamma} \mathbf{X}$, freely adding a factorisation $\gamma = \alpha\beta$.*
- (3) *Pushouts of the form $[1]_{[1]} \leftarrow [1]_{\{i\}} \xrightarrow{\gamma} \mathbf{X}$ for $i = 0, 1$, where $\gamma : x \rightarrow y$ is an arrow in \mathbf{X} such that x has no nontrivial incoming arrows and y has no nontrivial outgoing arrows.*

Proof. Let us first give explicit descriptions of these three types of strict pushouts in $\text{Cat}(\text{sSet}^+)$, for an arbitrary marked simplicial category \mathbf{X} . These will show that when \mathbf{X} arises from a gaunt 2-category, then so does the pushout \mathbf{X}' .

Case (1): We only treat the pushout along $\{0\} \rightarrow [1]_A$. The pushout \mathbf{X}' contains \mathbf{X} as a full subcategory, together with a new object z , so that for any object $u \in \mathbf{X}$,

$$\text{Hom}_{\mathbf{X}'}(u, z) = A \times \text{Hom}_{\mathbf{X}}(u, x), \quad \text{Hom}_{\mathbf{X}'}(z, u) = \emptyset, \quad \text{Hom}_{\mathbf{X}'}(z, z) = *.$$

Composition is defined by acting on the right factor of $A \times \text{Hom}_{\mathbf{X}}(u, x)$. Case (2): The pushout \mathbf{X}' then freely adds a factorisation $\gamma = \alpha\beta$, where α has source x , β has target y , and they have a new object z as common target and source, respectively. More precisely, \mathbf{X}' has one additional object z and mapping categories

$$\begin{aligned} \text{Hom}_{\mathbf{X}'}(u, v) &= \text{Hom}_{\mathbf{X}}(u, v), & \text{Hom}_{\mathbf{X}'}(u, z) &= \alpha \cdot \text{Hom}_{\mathbf{X}}(u, x), \\ \text{Hom}_{\mathbf{X}'}(z, v) &= \text{Hom}_{\mathbf{X}}(y, v) \cdot \beta, & \text{Hom}_{\mathbf{X}'}(z, z) &= \{\text{id}_z\} \sqcup \alpha \cdot \text{Hom}_{\mathbf{X}}(y, x) \cdot \beta \end{aligned}$$

for $u, v \in \mathbf{X}$. Here, the notation $\alpha \cdot \text{Hom}_{\mathbf{X}}(u, x)$ indicates that $\alpha \circ (-) : \text{Hom}_{\mathbf{X}}(u, x) \rightarrow \text{Hom}_{\mathbf{X}'}(u, z)$ is an isomorphism for all $u \in \mathbf{X}$. The composition is then the evident one, using the (formal) relation that $\alpha\beta = \gamma$.

Case (3): The pushout \mathbf{X}' has the same objects and mapping categories as \mathbf{X} , except for $\text{Hom}_{\mathbf{X}'}(x, y)$, which is given by a (homotopy) pushout $[1] \leftarrow \{i\} \rightarrow \text{Hom}_{\mathbf{X}}(x, y)$. Note that when $\text{Hom}_{\mathbf{X}}(x, y)$ is the nerve of a gaunt 1-category, this pushout of marked simplicial sets is weakly equivalent to the nerve of a gaunt 1-category (essentially by Case (1)).

It remains to show that the above (strict) pushouts also model the pushout in the ∞ -category Cat_2 . From the above descriptions, one sees that a Dwyer–Kan equivalence of marked simplicial categories $\mathbf{X} \rightarrow \mathbf{Y}$ induces a Dwyer–Kan equivalence between the resulting pushouts. It clearly induces weak equivalences on mapping objects, and since we add at most one extra object, it remains essentially surjective on homotopy categories. Since $\text{Cat}(\text{sSet}^+)$ is left proper [Lu09a, Proposition A.3.2.4], this means that the above pushouts are all homotopy pushouts, and the result follows. \square

The ∞ -category Cat_2 admits a closed (non-symmetric) monoidal structure given by the (oplax) Gray tensor product \boxtimes . The Gray tensor product is induced by a Quillen bifunctor $\boxtimes: \text{sSet}^{\text{sc}} \times \text{sSet}^{\text{sc}} \rightarrow \text{sSet}^{\text{sc}}$. The scaled simplicial set $(\mathbf{X}, S) \boxtimes (\mathbf{Y}, T)$ equals $(\mathbf{X} \times \mathbf{Y}, S \boxtimes T)$, where a 2-simplex (σ, σ') is in $S \boxtimes T$ if the following conditions hold:

- (1) $(\sigma, \sigma') \in S \times T$,
- (2) σ factors through $\Delta^2 \rightarrow \Delta^{\{1,2\}}$ or σ' factors through $\Delta^2 \rightarrow \Delta^{\{0,1\}}$.

See [GHL21] for the details of this construction. Furthermore, by [HHLN23, Proposition 5.1.9], its value on the pair $([m], [n])$ is naturally equivalent to the expected (gaunt) $(\infty, 2)$ -category

$$\begin{array}{ccccccc}
 00 & \longrightarrow & 01 & \longrightarrow & 02 & \dashrightarrow & 0n \\
 \downarrow & \nearrow & \downarrow & \nearrow & \downarrow & \nearrow & \downarrow \\
 10 & \longrightarrow & 11 & \longrightarrow & 12 & \dashrightarrow & 1n \\
 \vdots & \nearrow & \vdots & \nearrow & \vdots & \nearrow & \vdots \\
 m0 & \longrightarrow & m1 & \longrightarrow & m2 & \dashrightarrow & mn.
 \end{array} \tag{7.4}$$

The internal mapping objects induced by the Gray tensor product via

$$\text{Hom}_{\text{Cat}_2}(\mathbf{A}, \mathbf{Fun}^{\text{lax}}(\mathbf{B}, \mathbf{X})) \simeq \text{Hom}_{\text{Cat}_2}(\mathbf{A} \boxtimes \mathbf{B}, \mathbf{X}) \simeq \text{Hom}_{\text{Cat}_2}(\mathbf{B}, \mathbf{Fun}^{\text{opl}}(\mathbf{A}, \mathbf{X}))$$

are by definition the $(\infty, 2)$ -categories of 2-functors and (op)lax natural transformations between them; see [Ha21, Definition 3.9].

Let us now describe the complete Segal ∞ -groupoid models for the fibrations

$$(s, t): \text{Ar}^{\text{opl}}(\mathbf{X}) \rightarrow X \times X, \qquad (s, t): \text{Tw}^r(\mathbf{X}) \rightarrow X \times X^{\text{op}}$$

associated to an $(\infty, 2)$ -category \mathbf{X} . We will start with the oplax arrow ∞ -category.

Definition 7.5. Let \mathbf{X} be a $(\infty, 2)$ -category. The *oplax arrow ∞ -category* $\text{Ar}^{\text{opl}}(\mathbf{X})$ is the ∞ -category underlying the oplax functor ∞ -category $\mathbf{Ar}^{\text{opl}}(\mathbf{X}) = \mathbf{Fun}^{\text{opl}}([1], \mathbf{X})$.

Informally, $\text{Ar}^{\text{opl}}(\mathbf{X})$ is the ∞ -category with objects given by arrows of \mathbf{X} , such that morphisms from f to g are given by oplax commuting squares:

$$\begin{array}{ccc}
 x & \longrightarrow & x' \\
 f \downarrow & \nearrow & \downarrow g \\
 y & \longrightarrow & y'.
 \end{array}$$

More precisely, $\text{Ar}^{\text{opl}}(\mathbf{X})$ can be characterised in terms of the Gray tensor product by the natural equivalence

$$\text{Hom}_{\text{Cat}}(S, \text{Ar}^{\text{opl}}(\mathbf{X})) \simeq \text{Hom}_{\text{Cat}_2}([1] \boxtimes S, \mathbf{X}).$$

Example 7.6. If \mathbf{X} is a gaunt 2-category (i.e., a 0-truncated object in Cat_2), then the above natural equivalence becomes a natural bijection of sets. It follows that $\text{Ar}^{\text{opl}}(\mathbf{X})$ is a gaunt 1-category (i.e.,

a strict category without nontrivial isomorphisms), and from the description (7.4) of the Gray tensor product, one sees that it coincides with the classical oplax arrow category of \mathbf{X} .

Remark 7.7. Of course, the lax arrow category $\text{Ar}^{\text{lax}}(\mathbf{X})$ is defined by a similar universal property:

$$\text{Hom}_{\text{Cat}}(S, \text{Ar}^{\text{lax}}(\mathbf{X})) \simeq \text{Hom}_{\text{Cat}_2}(S \boxtimes [1], \mathbf{X}).$$

The description of the Gray tensor product of simplices (7.4) shows that for any simplex $[m]$, there is a natural equivalence of gaunt 2-categories $[1] \boxtimes ([m]^{\text{op}}) \simeq ([m] \boxtimes [1]^{\text{op}})^{\text{op}}$. By adjunction, this determines a natural equivalence

$$\text{Ar}^{\text{opl}}(\mathbf{X})^{\text{op}} \simeq \text{Ar}^{\text{lax}}(\mathbf{X}^{1-\text{op}}) \tag{7.8}$$

where $\mathbf{X}^{1-\text{op}}$ has only the directions of the 1-morphisms inverted. On objects, this equivalence sends an arrow in \mathbf{X} to the opposite arrow in $\mathbf{X}^{1-\text{op}}$.

Proposition 7.9. Suppose \mathbf{X} is an $(\infty, 2)$ -category. Then the functor

$$(s, t): \text{Ar}^{\text{opl}}(\mathbf{X}) \rightarrow X \times X$$

is an orthofibration where an edge σ , given by an oplax square

$$\begin{array}{ccc} x & \longrightarrow & x' \\ f \downarrow & \rho \nearrow & \downarrow g \\ y & \longrightarrow & y', \end{array}$$

over $\iota X \times X$ is cocartesian if and only if ρ is invertible, and similarly, an edge over $X \times \iota X$ is cartesian if and only if ρ is invertible. More formally, a morphism $\sigma: [1] \boxtimes [1] \rightarrow \mathbf{X}$ over $\iota X \times X$ (resp. $X \times \iota X$) is cocartesian (resp. cartesian) if and only if it factors through the 2-functor $[1] \boxtimes [1] \rightarrow [1] \times [1]$.

Proof. Let us first show that a square $\sigma: [1] \times [1] \rightarrow \mathbf{X}$ (i.e., a square σ for which ρ is an equivalence), corresponding to an arrow in $\text{Ar}^{\text{opl}}(\mathbf{X})$ living over $\iota X \times X$, is cocartesian. To see this, consider the following two equivalent unique lifting problems:

$$\begin{array}{ccc} \Lambda_0[2] & \longrightarrow & \text{Ar}^{\text{opl}}(\mathbf{X}) \\ \downarrow & \nearrow & \downarrow (s,t) \\ [2] & \longrightarrow & X \times X \end{array} \qquad \begin{array}{ccc} \Lambda_0[2] \boxtimes [1] & \amalg & [2] \times \{0, 1\} \longrightarrow \mathbf{X} \\ \Lambda_0[2] \times \{0, 1\} & \downarrow & \nearrow \\ [2] \boxtimes [1], & & \end{array}$$

where $\Lambda_0[2]$ is the ∞ -category $1 \leftarrow 0 \rightarrow 2$. Using the explicit description of the Gray tensor product of simplices of (7.4), the right vertical map is the inclusion of the sub- $(\infty, 2)$ -category of $[2] \boxtimes [1]$ given by

$$\begin{array}{ccccc} 10 & \xleftarrow{\quad} & 00 & \xrightarrow{\quad} & 20 \\ \downarrow & \swarrow & \downarrow & \searrow & \downarrow \\ 11 & \xleftarrow{\quad} & 01 & \xrightarrow{\quad} & 21. \end{array}$$

Now suppose that the morphism $0 \leq 1$ in $\Lambda_0[2]$ projects to $\iota X \times X$ and the corresponding map $[1] \boxtimes [1] \rightarrow \mathbf{X}$ factors over $[1] \times [1]$. This means that in the above diagram, the left oplax square

commutes and that $00 \rightarrow 10$ is an equivalence. The ∞ -groupoid of such diagrams is given by the ∞ -groupoid of 2-functors from the $(\infty, 2)$ -category

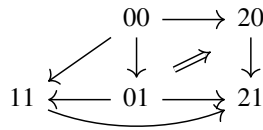

to \mathbf{X} , where the left triangle commutes. For example, this follows by decomposing the 2-category before as a pushout in Cat_2 using Proposition 7.3 and then observing that the 2-category

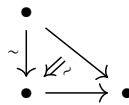

is equivalent to $[1]$. A similar argument shows that the ∞ -groupoid of diagrams $[2] \boxtimes [1] \rightarrow \mathbf{X}$ such that the morphism $0 \leq 1$ in $[2]$ projects to $\iota X \times X$ and the corresponding map $[1] \boxtimes [1] \rightarrow \mathbf{X}$ factors over $[1] \times [1]$ is also equivalent to the ∞ -groupoid of 2-functors from the $(\infty, 2)$ -category above to \mathbf{X} . The functor

$$\text{Hom}_{\text{Cat}_2}([2] \boxtimes [1], \mathbf{X}) \longrightarrow \text{Hom}_{\text{Cat}_2}(\Lambda_0[2] \boxtimes [1], \coprod_{\Lambda_0[2] \times \{0,1\}} [2] \times \{0,1\}, \mathbf{X})$$

lives over the restriction to $[0, 1] \boxtimes [1]$. By the previous argument, taking fibres over σ , we obtain an equivalence, and so we conclude that σ is a cocartesian edge.

Next, note that for any arrow in $\iota X \times X$ and a lift of its domain, there exists an (s, t) -cocartesian lift $\sigma: [1] \times [1] \rightarrow \mathbf{X}$ and that lifts of this form are closed under equivalence. This shows both that there are enough (s, t) -cocartesian edges over $\iota X \times X$, and that, up to equivalence, all (s, t) -cocartesian lifts over $\iota X \times X$ are of the form asserted in the proposition.

A dual argument proves the existence and form of (s, t) -cartesian arrows over $X \times \iota X$. It follows that (s, t) is a curved orthofibration in the sense of Definition 6.4.

To show that (s, t) is an orthofibration, consider $\alpha: a' \rightarrow a, \beta: b \rightarrow b'$ and let $f: a \rightarrow b$ be an object in the fibre $\text{Ar}^{\text{opl}}(\mathbf{X})_{(a,b)}$. We have to show that the interpolating edge associated to this data is an equivalence. Because interpolating edges are unique, we may equivalently exhibit a commutative square in $\text{Ar}^{\text{opl}}(\mathbf{X})$ living over the square

$$\begin{array}{ccc}
 (a', b) & \xrightarrow{(\text{id}, \beta)} & (a', b') \\
 (\alpha, \text{id}) \downarrow & & \downarrow (\alpha, \text{id}) \\
 (a, b) & \xrightarrow{(\text{id}, \beta)} & (a, b'),
 \end{array}$$

whose bottom left corner is f and whose horizontal and vertical morphisms are cocartesian and cartesian, respectively; indeed, in this case, the interpolating edge is the identity on $\beta f \alpha$ in $\text{Ar}^{\text{opl}}(\mathbf{X})$. Such a square

is given by the following cube in \mathbf{X}

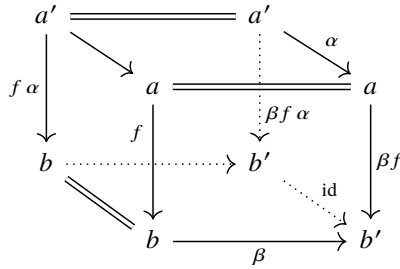

in which all faces commute. □

Let us now introduce the model for the enhanced twisted arrow ∞ -category given in [AGS23], which is constructed via the model of scaled simplicial sets.

Notation 7.10. In the following, we will denote the image of $i \in \Delta^n$ under the inclusion $\Delta^n \subset \Delta^n \star \Delta^{n,op}$ by i and the image of $j \in \Delta^{n,op}$ under the inclusion of $\Delta^{n,op} \subset \Delta^n \star \Delta^{n,op}$ by \bar{j} .

Definition 7.11. Consider the cosimplicial object

$$\kappa_r : \Delta \longrightarrow \text{sSet}^{\text{sc}}; \quad [n] \longmapsto \Delta^n \star_{\text{sc}} \Delta^{n,op}$$

sending each n to the join $\Delta^n \star \Delta^{n,op}$, where a 2-simplex $\sigma \in \Delta^n \star \Delta^{n,op}$ is thin if one of the following conditions holds:

- (i) σ is degenerate,
- (ii) σ is contained totally in either Δ^n or $\Delta^{n,op}$,
- (iii) $\sigma = \Delta^{\{i,j,\bar{k}\}}$ for $i < j \leq k$, or
- (iv) $\sigma = \Delta^{\{k,\bar{j},i\}}$ for $i < j \leq k$.

The functor κ_r induces a functor $\text{Tw}^r = S_{\kappa_r} : \text{sSet}^{\text{sc}} \longrightarrow \text{sSet}$ from scaled simplicial sets to simplicial sets such that $\text{Tw}^r(\mathbf{X}, S)_n := \text{Hom}_{\text{sSet}^{\text{sc}}}(\kappa_r([n]), (\mathbf{X}, S))$. We enhance this to a functor with values in marked simplicial sets by declaring an edge in $\text{Tw}^r(\mathbf{X}, S)$ to be marked if it arises from a totally thin diagram $(\Delta^1 \star \Delta^{1,op})^\# \longrightarrow (\mathbf{X}, S)$ and write

$$\text{Tw}_+^r(-) : \text{sSet}^{\text{sc}} \longrightarrow \text{sSet}^+$$

for the resulting functor. Note that the two inclusions $(\Delta^n)^\# \hookrightarrow (\Delta^n) \star_{\text{sc}} \Delta^{n,op} \hookleftarrow (\Delta^{n,op})^\#$ induce a map $\text{Tw}^r(\mathbf{X}, S) \rightarrow X \times X^{op}$.

Theorem 7.12 (Abellán García, Stern). *Let $p : (\mathbf{Y}, T) \longrightarrow (\mathbf{X}, S)$ be a fibration between fibrant scaled simplicial sets. Then the map*

$$\text{Tw}_+^r(\mathbf{Y}, T) \longrightarrow \text{Tw}_+^r(\mathbf{X}, S) \times_{X \times X^{op}} Y \times Y^{op}$$

is a fibration between fibrant objects in the cartesian model structure on $(\text{sSet}^+)/Y \times Y^{op}$ (where all arrows in $X \times X^{op}$ and $Y \times Y^{op}$ are marked).

For each fibrant scaled simplicial set (\mathbf{X}, S) , the cartesian fibration $\text{Tw}^r(\mathbf{X}, S) \longrightarrow X \times X^{op}$ is classified by the functor $\text{Hom}_{\mathbf{X}} : X^{op} \times X \longrightarrow \text{Cat}$.

Proof. For the first part, it suffices to verify that $\text{Tw}_+^r(\mathbf{Y}, T) \longrightarrow \text{Tw}_+^r(\mathbf{X}, S) \times_{X \times X^{op}} Y \times Y^{op}$ has the right lifting property with respect to all marked anodyne maps [Lu17, Proposition B.2.7]. Let us write L for the left adjoint of Tw_+^r and note that for each marked simplicial set (A, E) , there is a natural map

$A^\# \amalg A^{\text{op},\#} \longrightarrow L(A, E)$, such that mapping into (\mathbf{X}, S) , we obtain the value of the canonical projection $\text{Tw}^r(\mathbf{X}, S) \longrightarrow X \times X^{\text{op}}$ on (A, E) . The desired right lifting property now follows from the fact that for each (generating) marked anodyne map $(A, E) \longrightarrow (B, F)$, the map

$$L(A, E) \amalg_{A^\# \amalg A^{\text{op},\#}} (B^\# \amalg B^{\text{op},\#}) \longrightarrow L(B, F)$$

is a scaled anodyne map [AGS23, Lemma 2.9 and 2.10]. The second part of the theorem is [AGS23, Theorem 3.3]. □

Corollary 7.13. *The functor $\text{Tw}^r : \text{sSet}^{\text{sc}} \longrightarrow \text{sSet}$ is a right Quillen functor, where sSet is endowed with the Joyal model structure.*

Proof. The left adjoint to Tw^r preserves cofibrations, which are simply monomorphisms. Furthermore, Theorem 7.12 implies that the map

$$\text{Tw}_+^r(\mathbf{Y}, T) \longrightarrow \text{Tw}_+^r(\mathbf{X}, S) \times_{X \times X^{\text{op}}} Y \times Y^{\text{op}} \longrightarrow \text{Tw}_+^r(\mathbf{X}, S)$$

is a composite of fibrations in the cartesian model structure. Since fibrations in the cartesian model structure are, in particular, categorical fibrations [Lu09a, Proposition 3.1.5.3], we conclude that Tw^r sends fibrations between fibrant scaled simplicial sets to categorical fibrations between quasicategories. This suffices by [Jo08, Proposition E.2.14]. □

Definition 7.14. The right Quillen functor from Corollary 7.13 induces a right adjoint functor of ∞ -categories which we will denote $\text{Tw}^r : \text{Cat}_2 \longrightarrow \text{Cat}$ and refer to as taking the *oplax twisted arrow ∞ -category*.

To compare with the oplax arrow category, it will be convenient to give a slightly different presentation of $\text{Tw}^r(\mathbf{X})$ in terms of Segal ∞ -groupoids (which a posteriori does not make use of scaled simplicial sets). To this end, let us make the following observation:

Definition 7.15. Let us write $[n] \star_{\text{opl}} [n]^{\text{op}}$ for the gaunt 2-category informally depicted as

$$\begin{array}{ccccccc} 0 & \longrightarrow & 1 & \longrightarrow & 2 & \longrightarrow & \dots & \longrightarrow & n \\ \downarrow & \Longrightarrow & \downarrow & \Longrightarrow & \downarrow & \Longrightarrow & & \Longrightarrow & \downarrow \\ \bar{0} & \longleftarrow & \bar{1} & \longleftarrow & \bar{2} & \longleftarrow & \dots & \longleftarrow & \bar{n}. \end{array}$$

More precisely, the categories $\text{Hom}_{[n] \star_{\text{opl}} [n]^{\text{op}}}(i, j)$ and $\text{Hom}_{[n] \star_{\text{opl}} [n]^{\text{op}}}(\bar{j}, \bar{i})$ are a point if $i \leq j$ and empty otherwise, and $\text{Hom}_{[n] \star_{\text{opl}} [n]^{\text{op}}}(i, \bar{j})$ is the poset of integers $\max(i, j) \leq' \leq n$, ordered by size. We will refer to these integers as *heights*. The composition maps preserve these heights. One readily verifies that this defines a functor $\mathbf{\Delta} \longrightarrow \text{Gaunt}_2 \subseteq \text{Cat}_2$.

Lemma 7.16. *For each n , there is a natural equivalence between $[n] \star_{\text{opl}} [n]^{\text{op}}$ and the $(\infty, 2)$ -category presented by the scaled simplicial set $\Delta^n \star_{\text{sc}} \Delta^{n,\text{op}}$.*

Proof. We will provide a natural weak equivalence of cosimplicial diagrams in $\text{Cat}(\text{sSet}^+)$

$$\phi : \mathfrak{C}^{\text{sc}}(\Delta^n \star_{\text{sc}} \Delta^{n,\text{op}}) \longrightarrow [n] \star_{\text{opl}} [n]^{\text{op}},$$

where the target is viewed as a marked simplicially enriched category by taking nerves of the mapping categories.

Unraveling the definitions, $\mathfrak{C}^{\text{sc}}(\Delta^n \star_{\text{sc}} \Delta^{n,\text{op}})$ is given as follows. Its objects are the objects of the poset $0 \leq \dots \leq n \leq \bar{n} \leq \dots \leq \bar{0}$. Given two such objects a, b , the simplicial set $\text{Hom}(a, b)$ is the nerve

of the poset of chains $a = x_0 \leq x_1 \leq \dots \leq x_l = b$, ordered by inclusion. Within (the nerve of) this poset of chains, the following arrows are marked:

- (a) if $a = i$ and $b = j$ are both contained in the first half or if $a = \bar{i}$ and $b = \bar{j}$ are both contained in the second half, then *all* inclusions of chains are marked.
- (b) for $a = i$ and $b = \bar{j}$, let us define the *height* of a chain $\sigma: i = x_0 \leq x_1 \leq \dots \leq x_l = \bar{j}$ to be the largest number k such that either k or \bar{k} is contained in σ . Then an inclusion of chains is marked if it does not change the height.

The map ϕ is then given by the identity on objects and on (nerves of) mapping categories it (a) either sends all chains to the point or (b) takes the height of a chain. It suffices to verify that these maps between mapping categories are exactly the localisations at the marked arrows. This is evident in case (a), since the poset of chains is either empty or a cube (hence contractible). In case (b), the functor sending a chain to its height has a **fully faithful right adjoint**, sending each height k to the maximal chain $i \leq i + 1 \leq \dots \leq k - 1 \leq k \leq \bar{k} \leq \bar{k} - 1 \leq \dots \leq \bar{j} + 1 \leq \bar{j}$. □

Corollary 7.17. *Let \mathbf{X} be an $(\infty, 2)$ -category. Then the simplicial ∞ -groupoid*

$$[n] \longmapsto \text{Hom}_{\text{Cat}_2}([n] \star_{\text{opl}} [n]^{\text{op}}, \mathbf{X})$$

is a complete Segal ∞ -groupoid, whose associated ∞ -category is naturally equivalent to $\text{Tw}^r(\mathbf{X})$.

Proof. Corollary 7.13 and Lemma 7.16 identify the simplicial ∞ -groupoid $\text{Hom}_{\text{Cat}_2}([n] \star_{\text{opl}} [n]^{\text{op}}, \mathbf{X})$ with $\text{N}(\text{Tw}^r(\mathbf{X}))$. □

We will now compute the image of $\text{Ar}^{\text{opl}}(\mathbf{X})$ under the dualisation functor

$$\text{SD}^{\text{ct}}: \text{Ortho}(X, X) \rightarrow \text{Cart}(X, X^{\text{op}})$$

and show it is equivalent to the functor

$$(s, t): \text{Tw}^r(\mathbf{X}) \rightarrow X \times X^{\text{op}}.$$

Recall that SD^{ct} is given as the composite of $(-)^{\text{op}}$ and Span^\perp . Since Remark 7.7 identifies the opposite of the oplax arrow category of \mathbf{X} with the lax arrow category of $\mathbf{X}^{1-\text{op}}$, we find that the dual of $(s, t): \text{Ar}^{\text{opl}}(\mathbf{X}) \rightarrow X \times X$ is given by

$$\text{SD}^{\text{ct}}(s, t): \mathcal{D} := \text{Span}^\perp(\text{Ar}^{\text{lax}}(\mathbf{X}^{1-\text{op}})) \longrightarrow X \times X^{\text{op}}.$$

Unwinding definitions, we find that \mathcal{D} is the associated ∞ -category of the complete Segal ∞ -groupoid given in level n by the sub- ∞ -groupoid of

$$\text{Hom}_{\text{Cat}_2}(\text{Tw}^r([n]) \boxtimes [1], \mathbf{X}^{1-\text{op}})$$

spanned by the functors

$$f: \text{Tw}^r([n]) \boxtimes [1] \longrightarrow \mathbf{X}^{1-\text{op}}$$

which send

- (i) $\text{Tw}^r([n])_{\text{in}} \boxtimes \{1\}$ to ιX^{op} ,
- (ii) $\text{Tw}^r([n])^{\text{eg}} \boxtimes \{0\}$ to ιX^{op} , and
- (iii) every 2-morphism $\sigma \subseteq \text{Tw}^r([n])_{\text{in}} \boxtimes [1]$ to an invertible 2-morphism in \mathbf{X} .

This is, of course, naturally equivalent to the ∞ -groupoid of functors $f: (\text{Tw}^r([n]) \boxtimes [1])^{1\text{-op}} \rightarrow \mathbf{X}$ satisfying analogous conditions. To obtain a functor $\mathcal{D} \rightarrow \text{Tw}^r(\mathbf{X})$, we will write down a natural transformation of cosimplicial objects in Cat_2

$$\phi_n: (\text{Tw}^r([n]) \boxtimes [1])^{1\text{-op}} \longrightarrow [n] \star_{\text{opl}} [n]^{\text{op}}.$$

We will produce this map at the level of scaled simplicial sets, using that for a scaled simplicial set (\mathbf{Y}', T) modeling \mathbf{Y} , the opposite $\mathbf{Y}^{1\text{-op}}$ is modelled by $((\mathbf{Y}')^{\text{op}}, T)$. Let us therefore define

$$\phi_n: (\text{Tw}^r([n]) \times [1])^{\text{op}} \longrightarrow \Delta^n \star \Delta^{n,\text{op}}; \quad ((i \leq j), \epsilon) \longmapsto \begin{cases} \bar{i} & \epsilon = 0 \\ j & \epsilon = 1 \end{cases}$$

exactly as in Example 6.15. By inspection, this defines a map of scaled simplicial sets. For example, $\phi_n(\sigma, \sigma') = \Delta^{\{i,j,k\}}$ for $i \leq j \leq k$ when σ' equals $s_1: \Delta^2 \rightarrow \Delta^{\{0,1\}}$. By definition, this is thin in $\Delta \star_{\text{sc}} \Delta^{n,\text{op}}$. Similarly, one can readily show that the image of the other thin simplicies is thin. We conclude that the ϕ_n determine a natural transformation of cosimplicial objects in sSet^{sc} .

Example 7.18. Let us describe the induced map $\phi_n: (\text{Tw}^r([n]) \boxtimes [1])^{\text{op}} \rightarrow [n] \star_{\text{opl}} [n]^{\text{op}}$ in Cat_2 a bit more precisely in the case $n = 1$. In this case, the domain is the pushout in Cat_2 of two lax squares along a common 1-morphism, which is a gaunt 2-category by Proposition 7.3. In particular, the domain and codomain of ϕ_1 are gaunt 2-categories, and the map ϕ_1 is then given by the strict 2-functor

$$\begin{array}{ccccc} 00 & \xrightarrow{\sim} & 01 & \longleftarrow & 11 \\ \uparrow & \searrow & \uparrow & \swarrow_{\sim} & \uparrow \\ \bar{0}\bar{0} & \longrightarrow & \bar{0}\bar{1} & \longleftarrow & \bar{1}\bar{1} \end{array} \quad \longmapsto \quad \begin{array}{ccc} \bar{0} & \longleftarrow & \bar{1} \\ \uparrow & \Longrightarrow & \uparrow \\ 0 & \longrightarrow & 1 \end{array} \tag{7.19}$$

obtained by collapsing the 1- and 2-morphisms marked by \sim . To see that this agrees with the description of ϕ_1 in terms of scaled simplicial sets, it suffices to note that this strict 2-functor is uniquely determined by its values on objects and 1-morphisms.

Remark 7.20. More generally, since $[n] \star_{\text{opl}} [n]^{\text{op}}$ is a gaunt 2-category, ϕ_n is adjoint to a (strict) functor $\text{Tw}^r([n])^{\text{op}} \rightarrow \text{Ar}^{\text{opl}}([n] \star_{\text{opl}} [n]^{\text{op}})$ into its strict oplax arrow category (see Example 7.6). This functor sends each $(i \leq j)$ in $\text{Tw}^r([n])$ to the arrow $j \rightarrow i$ in $[n] \star_{\text{opl}} [n]^{\text{op}}$ of minimal height.

For each \mathbf{X} , the maps ϕ_n induce a natural transformation of simplicial ∞ -groupoids

$$N\mathcal{D} \longrightarrow S_{\kappa_r}(\mathbf{X}),$$

which, after taking associated ∞ -categories, gives a functor $\Phi: \mathcal{D} \rightarrow \text{Tw}^r(\mathbf{X})$ which evidently commutes with the canonical functors to $X \times X^{\text{op}}$.

Theorem 7.21. *The functor*

$$\Phi: \mathcal{D} \longrightarrow \text{Tw}^r(\mathbf{X})$$

is an equivalence of ∞ -categories. Consequently, the orthofibration $(s, t): \text{Ar}^{\text{opl}}(\mathbf{X}) \rightarrow X \times X$ classifies the mapping ∞ -category functor

$$\text{Hom}_{\mathbf{X}}(-, -): X^{\text{op}} \times X \longrightarrow \text{Cat}.$$

Proof. Given the first part of the theorem, the second part follows from Corollary 6.14 and Theorem 7.12. Because both sides of the equivalence are the associated ∞ -category of Segal ∞ -groupoids, and the functor is induced by a natural transformation of Segal ∞ -groupoids, it suffices to prove that Φ_0 and

Φ_1 are equivalences of ∞ -groupoids. Note that the map ϕ_0 is simply the identity on $[1]$, so that Φ_0 is certainly an equivalence.

To see that Φ_1 is an equivalence, note that its domain $N(\mathcal{D})_1$ is the ∞ -groupoid of 2-functors from the gaunt 2-category $(\text{Tw}^r([1]) \times [1])^{\text{op}}$

$$\begin{array}{ccccc} 00 & \xrightarrow{\sim} & 01 & \longleftarrow & 11 \\ \uparrow & \Downarrow & \uparrow & \swarrow \sim & \uparrow \\ \bar{0}\bar{0} & \longrightarrow & \bar{0}\bar{1} & \longleftarrow & \bar{1}\bar{1} \end{array}$$

sending the marked 1- and 2-cells to equivalences in \mathbf{X} . It therefore suffices to verify that the functor ϕ_1 (7.19) is the universal functor of $(\infty, 2)$ -categories that collapses these marked morphisms and 2-morphisms.

To see this, we observe that the above gaunt 2-category can be obtained by ‘cell attachments’, along the lines of the following picture:

$$\begin{array}{ccccc} 00 & \xrightarrow{\sim} & 01 & \longleftarrow & 11 \\ \uparrow & \curvearrowright & \uparrow & \swarrow \sim & \uparrow \\ \bar{0}\bar{0} & \longrightarrow & \bar{0}\bar{1} & \longleftarrow & \bar{1}\bar{1} \end{array}$$

Here, we start from the middle vertical arrow and attach the bottom horizontal arrows, then the 2-cells and finally the factorisations over 00 and 11. Each step is given by a pushout of gaunt 2-categories as described in Proposition 7.3 (which is hence also a pushout in Cat_2).

For each pushout where we add a marked cell, collapsing the resulting cell in Cat_2 simply has the result of not adding a cell at all. Consequently, the $(\infty, 2)$ -category obtained from $(\text{Tw}^r([1]) \times [1])^{\text{op}}$ by collapsing the marked cells is the gaunt 2-category obtained by performing only those cell attachments where no marked cell was added. The result of this is then precisely $[1] \star_{\text{opl}} [1]^{\text{op}}$, and the collapsing map is precisely ϕ_1 . \square

Remark 7.22. Note that the functor $\text{Hom}_{\text{Cat}}(*, -): \text{Cat} \rightarrow \text{Cat}$ is equivalent to the identity on Cat . Therefore, we conclude immediately from the previous theorem that the functor

$$t: \text{Ar}^{\text{opl}}(\mathbf{Cat}) \times_{\text{Cat}} \{*\} \longrightarrow \text{Cat}$$

is a model for the universal cocartesian fibration (i.e., the cocartesian fibration which classifies the identity on Cat). The fibre of $s: \text{Ar}^{\text{opl}}(\mathbf{Cat}) \rightarrow \text{Cat}$ over $*$ is one definition for the oplax slice category $*//^{\text{opl}} \text{Cat}$, and the previous theorem therefore gives one way to make precise the statement that the forgetful functor $*//^{\text{opl}} \text{Cat} \rightarrow \text{Cat}$ is the universal cocartesian fibration.

The universal cartesian fibration has a similar description. Indeed, by Remark 7.7, the functor

$$(t^{\text{op}}, s^{\text{op}}): \text{Ar}^{\text{lax}}(\mathbf{X})^{\text{op}} \longrightarrow X^{\text{op}} \times X^{\text{op}}$$

is equivalent to

$$(s, t): \text{Ar}^{\text{opl}}(\mathbf{X}^{1-\text{op}}) \longrightarrow X^{\text{op}} \times X^{\text{op}}.$$

Again by Theorem 7.21, this classifies the enhanced mapping functor of $\mathbf{X}^{1-\text{op}}$, which is equivalent to the functor

$$X \times X^{\text{op}} \simeq X^{\text{op}} \times X \xrightarrow{\text{Hom}_{\mathbf{X}}(-, -)} \text{Cat}.$$

Applying this in the case $\mathbf{X} = \mathbf{Cat}$, we obtain that the functor

$$t^{\text{op}} : \text{Ar}^{\text{Lax}}(\mathbf{Cat})^{\text{op}} \times_{\text{Cat}^{\text{op}}} \{*\} \longrightarrow X^{\text{op}}$$

is a cartesian fibration which classifies the identity on \mathbf{Cat} . Because the fibre of $t : \text{Ar}^{\text{Lax}}(\mathbf{Cat}) \rightarrow \mathbf{Cat}$ over $\{*\}$ is one definition for the lax over-category, this makes precise the statement that $(* // \mathbf{Cat})^{\text{op}} \rightarrow \text{Cat}^{\text{op}}$ is the universal cartesian fibration.

Remark 7.23. Let us also briefly discuss the cocartesian fibration encoding the enhanced mapping functor of an $(\infty, 2)$ -category \mathbf{X} . Just as for ∞ -categories, it is given by a version of the left twisted arrow ∞ -category. However, simply taking the opposite of $\text{Tw}^r(\mathbf{X})$, as one does for ∞ -categories, would also apply $(-)^{\text{op}}$ to the fibres. Therefore, we instead consider the simplicial object $\kappa_l = (\kappa_r)^{\text{rev}, 2\text{-op}}$ in Cat_2 obtained from that defining Tw^r by reversing the simplicial direction and taking opposites for 2-morphisms at each level and define $\text{Tw}^\ell(\mathbf{X}) = S_{\kappa_l}(\mathbf{X})$. By direct inspection, one then finds $\text{Tw}^\ell(\mathbf{X}) \simeq \text{Tw}^r(\mathbf{X}^{2\text{-op}})^{\text{op}}$. In particular, it follows from Theorem 7.12 that

$$(s, t) : \text{Tw}^\ell(\mathbf{X}) \longrightarrow X^{\text{op}} \times X$$

is a cocartesian fibration, which classifies the composition

$$X^{\text{op}} \times X \xrightarrow{\text{Hom}_{\mathbf{X}^{2\text{-op}}}} \text{Cat} \xrightarrow{(-)^{\text{op}}} \text{Cat}.$$

We claim this composite is the enhanced mapping functor of \mathbf{X} . One way to see this is to note that the functor $(-)^{2\text{-op}} : \text{Cat}_2 \rightarrow \text{Cat}_2$ is modelled on categories enriched in marked simplicial sets (which we used to define the enhanced mapping functor) by changing the enrichment via $(-)^{\text{op}} : \text{sSet}_+ \rightarrow \text{sSet}_+$. Let us remark that the model of scaled simplicial sets does not seem to admit a simple implementation of reversing 2-morphisms, so, in particular, we do not know of a simplicial object in scaled simplicial sets giving rise to $\kappa^{\text{rev}, 2\text{-op}}$, and consequently also no explicit model for $\text{Tw}^\ell(\mathbf{X})$ as a scaled simplicial set even if \mathbf{X} is given as such. Nevertheless, applying the equivalence of Lemma 7.16, one can write down a cosimplicial diagram of gaunt 2-categories equivalent to κ_l .

Note also that $\text{Tw}^r(\mathbf{X}^{1\text{-op}}) \simeq \text{Tw}^r(\mathbf{X})$ as cartesian fibrations over $X \times X^{\text{op}}$, since $(\kappa_r)^{1\text{-op}} \simeq \kappa_r$.

Remark 7.24. For the sake of completeness, let us also mention the behaviour of Ar^{opl} and Ar^{Lax} under the two kinds of taking opposites. Recall that we have already seen in (7.8) that $\text{Ar}^{\text{opl}}(\mathbf{X}^{1\text{-op}}) \simeq \text{Ar}^{\text{Lax}}(\mathbf{X})^{\text{op}}$. We are left to note

$$\text{Ar}^{\text{opl}}(\mathbf{X}^{2\text{-op}}) \simeq \text{Ar}^{\text{opl}}(\mathbf{X}^{1\text{-op}})^{\text{op}} \simeq \text{Ar}^{\text{Lax}}(\mathbf{X}).$$

To see this, observe that both are orthofibrations over $X \times X$ and that the functors $X^{\text{op}} \times X \rightarrow \text{Cat}$ which both classify are equivalent by Theorem 7.21 and the corresponding statements for the twisted arrow ∞ -categories.

8. Naturality of the Yoneda embedding

In this short final section, we deduce the following result as an application of Lemma 6.20:

Theorem 8.1. *The Yoneda embedding $A \rightarrow \mathcal{P}(A)$ canonically extends to a natural transformation of functors $\text{Cat} \rightarrow \text{CAT}$ from the inclusion to the composite*

$$\text{Cat} \xrightarrow{\text{Fun}(-^{\text{op}}, \text{Gpd})} (\text{CAT}^{\text{R}})^{\text{op}} \simeq \text{CAT}^{\text{L}} \subseteq \text{CAT}.$$

Remark 8.2. As our model of the equivalence $(\text{CAT}^{\text{R}})^{\text{op}} \simeq \text{CAT}^{\text{L}}$, we take the equivalence of [HHLN23, Theorem 3.1.11]. Intuitively, it acts as the identity on objects and sends a left adjoint $L : C \rightarrow D$ to a choice of right adjoint $R : D \rightarrow C$.

Remark 8.3. This question was recently posed to the second author (among others) by D. Clausen during a visit to the University of Copenhagen, as it can be used to simplify a number of arguments in [CØJ21, Section 2] and appears missing from the literature so far. It is a lucky accident that our methods answer it.

Let us also mention that, building on Theorem 8.1, Ben Moshe and Schlack have recently upgraded the monoidal (and modal) versions of the Yoneda embedding to natural transformations as well; see [BMS21, Theorem D].

Before giving a proof of Theorem 8.1, let us briefly comment on related results that already appear in the literature. First, the characterisation of $\mathcal{P}(A)$ as the free cocompletion of A [Lu09a, Section 5.1.5] implies that the assignment $A \mapsto \mathcal{P}(A)$ extends to a functor equipped with a natural transformation $A \rightarrow \mathcal{P}(A)$ given pointwise by the Yoneda embedding (essentially by construction). However, it is not a priori clear that this second functor agrees with the one described in Theorem 8.1; let us write $\mathcal{P}_{\text{free}}$ and \mathcal{P}_{Kan} to distinguish these two functorialities, the first being the functoriality via the free cocompletion and the second the functoriality of the statement.

Without considering the naturality of the Yoneda embedding, one can produce a natural equivalence $\mathcal{P}_{\text{free}} \simeq \mathcal{P}_{\text{Kan}}$ as follows. Both of these functors are easily checked to factor as

$$\text{Cat} \xrightarrow{(-)^{\text{h}}} \text{Cat}^{\text{h}} \xrightarrow{\mathcal{P}} \text{CAT}^{\text{ccpt}} \subset \text{CAT},$$

where the second term denotes the ∞ -category of small idempotent complete ∞ -categories (and the first functor idempotent completion), and the third term the ∞ -category of cocomplete ∞ -categories admitting a set of completely compact objects that jointly detect equivalences, and functors among them preserving both colimits and completely compact objects. By an argument analogous to [Lu09a, Proposition 5.5.7.8], $\mathcal{P}_{\text{free}}$ is an equivalence between the middle two terms. Since $\mathcal{P}_{\text{free}}$ and \mathcal{P}_{Kan} are homotopic on individual morphism ∞ -groupoids [Lu09a, Proposition 5.2.6.3], the same follows for \mathcal{P}_{Kan} . But by a minor modification of Toën’s theorem [To05], Cat^{h} has a discrete automorphism ∞ -groupoid consisting of two objects (the identity and op), whence there is a unique natural equivalence between $\mathcal{P}_{\text{free}}$ and \mathcal{P}_{Kan} .

To conclude that the Yoneda embedding extends to a natural transformation as in Theorem 8.1, it thus remains to verify that this equivalence is given pointwise by the *identity* of $\mathcal{P}(A)$; the trouble is that this latter identification is not clear.

After this paper appeared, a proof of Theorem 8.1 along the lines just sketched was completed by Ramzi, with the additional input being a nifty rigidity result for the identity functor on Cat ; see [Ra23, Theorem 2.2].

Proof of Theorem 8.1. Recall that for any ∞ -category A , the Yoneda embedding $A \rightarrow \mathcal{P}(A)$ is defined as the adjoint of the functor $\text{Hom}_A: A^{\text{op}} \times A \rightarrow \text{Gpd}$, which in turn is given by the cocartesian unstraightening of $\text{Tw}^{\ell}(A) \rightarrow A^{\text{op}} \times A$. The definition of the twisted arrow category makes this left fibration functorial in A . More precisely, we can consider the pullback square

$$\begin{array}{ccc} E & \longrightarrow & \text{Ar}(\text{Cat}) \\ \downarrow & & \downarrow t \\ \text{Cat} \times \text{Cat} & \xrightarrow{(-)^{\text{op}} \times -} & \text{Cat} \end{array}$$

and note that Tw^{ℓ} defines a functor from Cat to the full subcategory of $F \subset E$ spanned by the left fibrations. Note that F is the cartesian unstraightening of the functor $(A, B) \mapsto \text{LFib}(A^{\text{op}} \times B)$, where the functoriality is in pullback. There are equivalences

$$\text{LFib}(A^{\text{op}} \times B) \xrightarrow{\text{Str}^{\text{cc}}} \text{Fun}(A^{\text{op}} \times B, \text{Gpd}) \simeq \text{Fun}(B, \mathcal{P}(A))$$

which are natural in the input ∞ -categories (where the contravariant functoriality on $\mathcal{P}(-)$ is given by precomposition). Writing $\mathcal{F}: (\text{Cat}^{\text{op}})^2 \rightarrow \text{CAT}$ for the functor sending $(A, B) \mapsto \text{Fun}(B, \mathcal{P}(A))$, we therefore obtain a functor

$$\text{Tw}^\ell : \text{Cat} \longrightarrow F \simeq \text{Un}^{\text{ct}}(\mathcal{F}).$$

On objects, this takes an ∞ -category A to its Yoneda embedding, and on morphisms, it witnesses the lax commutativity of the diagrams

$$\begin{array}{ccc} A & \longrightarrow & \mathcal{P}(A) \\ f \downarrow & \Downarrow & \uparrow f^* \\ B & \longrightarrow & \mathcal{P}(B) \end{array}$$

given pointwise by the maps $\text{Hom}_A(-, c) \longrightarrow \text{Hom}_B(f(-), f(c))$. It therefore contains all the requisite data for a natural transformation $A \longrightarrow \mathcal{P}(A)$ as in the statement.

To extract the desired natural transformation, curry \mathcal{F} into a functor

$$\text{Cat}^{\text{op}} \longrightarrow \text{Fun}(\text{Cat}^{\text{op}}, \text{CAT}), \quad B \longmapsto (A \mapsto \text{Fun}(B, \mathcal{P}(A))).$$

Now observe that this functor takes values in the subcategory of $\text{Fun}(\text{Cat}^{\text{op}}, \text{CAT})$ spanned by functors to CAT^{R} with left adjointable squares as morphisms. Via cartesian unstraightening, this ∞ -category is equivalent to $\text{BICART}(\text{Cat})$, the intersection the two subcategories $\text{COCART}(\text{Cat})$ and $\text{CART}(\text{Cat})$ in the over- ∞ -category CAT/Cat . Via cocartesian unstraightening, it is then also equivalent to the subcategory of $\text{Fun}(\text{Cat}, \text{CAT})$ spanned by functors into CAT^{L} and right adjointable squares.

Applying these equivalences to \mathcal{F} results in a functor \mathcal{G} in

$$\text{Fun}(\text{Cat}^{\text{op}}, \text{Fun}(\text{Cat}, \text{CAT})) \simeq \text{Fun}(\text{Cat}^{\text{op}} \times \text{Cat}, \text{CAT}),$$

which still has $\mathcal{G}(B, A) \simeq \text{Fun}(B, \mathcal{P}(A))$, but now the functoriality in the A -variable is by the left adjoint to restriction (i.e., by left Kan extension).

Let $\text{Un}^{\text{oc}}(\mathcal{G}) \longrightarrow \text{Cat} \times \text{Cat}$ be the orthocartesian unstraightening of \mathcal{G} . We claim that there is a canonical equivalence $\text{Un}^{\text{ct}}(\mathcal{F}) \simeq \text{Un}^{\text{oc}}(\mathcal{G})$. To this end, invoke Corollary 6.20 to write the cartesian unstraightening functor as

$$\text{Fun}(B^{\text{op}}, \text{Fun}(A^{\text{op}}, \text{CAT})) \xrightarrow{\text{Un}^{\text{ct}}} \text{Fun}(B^{\text{op}}, \text{CART}(A)) \xrightarrow{\text{Un}^{\text{ct}}} \text{CART}(A \times B)$$

and the orthocartesian one as

$$\text{Fun}(B^{\text{op}}, \text{Fun}(A, \text{CAT})) \xrightarrow{\text{Un}^{\text{cc}}} \text{Fun}(B^{\text{op}}, \text{COCART}(A)) \xrightarrow{\text{Un}^{\text{ct}}} \text{ORTHO}(A \times B).$$

But now by definition, \mathcal{G} and \mathcal{F} have the same image in $\text{Fun}(\text{Cat}^{\text{op}}, \text{BICART}(\text{Cat}))$, viewed as a subcategory of $\text{Fun}(\text{Cat}^{\text{op}}, \text{COCART}(\text{Cat}))$ and $\text{Fun}(\text{Cat}^{\text{op}}, \text{CART}(\text{Cat}))$, respectively. This gives the claim that $\text{Un}^{\text{ct}}(\mathcal{F}) \simeq \text{Un}^{\text{oc}}(\mathcal{G})$.

The resulting functor

$$\text{Tw}^\ell : \text{Cat} \rightarrow \text{Un}^{\text{oc}}(\mathcal{G})$$

again takes A to its Yoneda embedding, but this time morphisms witness lax commuting squares

$$\begin{array}{ccc} A & \longrightarrow & \mathcal{P}(A) \\ f \downarrow & \mu \swarrow & \downarrow f_i \\ B & \longrightarrow & \mathcal{P}(B). \end{array}$$

But by [Lu09a, Proposition 5.2.6.3] (or rather the second step of its proof), the natural transformation μ is an equivalence (i.e., the diagram actually commutes).

Armed with this information, consider the diagram

$$\begin{array}{ccc} \text{Un}^{\text{oc}}(\mathcal{G}) & \longrightarrow & \text{Un}^{\text{oc}}(\text{Fun}(-, -)) \\ \downarrow & & \downarrow \\ \text{Cat} \times \text{Cat} & \xrightarrow{(\mathcal{P}, \text{incl})} & \text{CAT} \times \text{CAT} \end{array}$$

whose top right corner is the oplax arrow ∞ -category $\text{Ar}^{\text{opl}}(\text{CAT})$ of large ∞ -categories by Theorem 7.21. Via the inclusion $\text{Hom}_{\text{CAT}}(A, B) \subseteq \text{Fun}(A, B)$, it contains the actual arrow ∞ -category $\text{Ar}(\text{CAT})$ as a wide subcategory, and by the previous observation, the composite

$$\text{Cat} \xrightarrow{\text{Tw}^\ell} \text{Un}^{\text{oc}}(\mathcal{G}) \longrightarrow \text{Ar}^{\text{opl}}(\text{CAT})$$

actually takes values in this subcategory. The resulting functor $\text{Cat} \rightarrow \text{Ar}(\text{CAT})$ is then the natural transformation we set out to construct. □

A. Uniqueness of straightening and dualisation

To resolve coherence questions surrounding the dualisation and straightening equivalences once and for all, we will prove a rigidity result in this appendix, implying that any two ways of straightening or dualising a two-variable fibration are naturally equivalent; namely, we compute the automorphism groups of the functors

$$\begin{aligned} \mathcal{F} &: \text{Cat}^{\text{op}} \times \text{Cat}^{\text{op}} \longrightarrow \text{CAT}, & (A, B) &\longmapsto \text{Fun}(A \times B, \text{Cat}), \\ \mathcal{F}_{\text{Gpd}} &: \text{Cat}^{\text{op}} \times \text{Cat}^{\text{op}} \longrightarrow \text{CAT}, & (A, B) &\longmapsto \text{Fun}(A \times B, \text{Gpd}) \\ \mathcal{F}_{\text{Gray}} &: \text{Cat}^{\text{op}} \times \text{Cat}^{\text{op}} \longrightarrow \text{CAT}; & (A, B) &\longmapsto \text{Fun}(A \boxtimes B, \mathbf{Cat}), \end{aligned}$$

following ideas of [BGN18], who treated the case of a single variable. Here, \boxtimes denotes the Gray tensor product (see Section 7), and $\text{Fun}(A \boxtimes B, \mathbf{Cat})$ denotes the ∞ -category of functors from the $(\infty, 2)$ -category $A \boxtimes B$ to the $(\infty, 2)$ -category of ∞ -categories. By [HHLN23, 5.2.9], the functor $\mathcal{F}_{\text{Gray}}$ is equivalent to the functor $\text{Gray}(-, -)$ which sends a pair (A, B) to the ∞ -category of Gray fibrations over $A \times B$ (see Remark 6.6).

Before we describe the result of our calculations, note that the functor \mathcal{F} carries a natural action of the group $\text{Aut}(\text{Cat})$, acting pointwise on $\text{Fun}(A \times B, \text{Cat})$ by postcomposition. When evaluated at $([0], [0]) \in \text{Cat}^{\times 2}$, this simply gives the canonical action of $\text{Aut}(\text{Cat})$ on Cat . By a theorem of Toën, $\text{Aut}(\text{Cat})$ is discrete with two path components, corresponding to the identity and $(-)^{\text{op}}: \text{Cat} \rightarrow \text{Cat}$ [To05]. Our goal will be to prove the following:

Theorem A.1. *Acting by postcomposition and evaluation at $([0], [0]) \in \text{Cat}^{\times 2}$ determines inverse equivalences*

$$\text{Aut}(\text{Cat}) \xrightleftharpoons{\sim} \text{Aut}(\mathcal{F}).$$

*In particular, $\text{Aut}(\mathcal{F})$ is discrete with $\pi_0 \text{Aut}(\mathcal{F}) = \mathbb{Z}/2$ having its nontrivial element induced by postcomposition with $(-)^{\text{op}}: \text{Cat} \rightarrow \text{Cat}$. Furthermore, $\text{Aut}(\mathcal{F}_{\text{Gpd}}) \simeq *$ and $\text{Aut}(\mathcal{F}_{\text{Gray}}) \simeq *$.*

Remark A.2. Orthocartesian (un)straightening restricts to a natural (un)straightening equivalence $\text{Str}^{\text{bi}}: \text{Bifib} \rightarrow \mathcal{F}_{\text{Gpd}}$ for bifibrations by [HHLN23, 2.3.15]. Theorem A.1 implies that the equivalence Str^{bi} in fact agrees with the equivalence from [St18], provided the latter is natural. This can be

verified using the techniques of [GHN17, Appendix A]; we refrain from working out further details, as we do not need the statement.

Remark A.3. As mentioned, the analogue of Theorem A.1 for the functor $A \mapsto \text{Fun}(A, \text{Cat})$ is one step in the proof of [BGN18, Theorem 1.4], and our proof below follows their strategy in the large. There is, however, one crucial difference: Barwick, Glasman and Nardin use Yoneda’s lemma to deduce that the automorphisms of the functor

$$\text{Cat}^{\text{op}} \rightarrow \text{GPD}, \quad A \mapsto \text{Hom}_{\text{Cat}}(A, \text{Cat})$$

are given by $\text{Aut}(\text{Cat})$. This suffices to establish the analogue of Theorem A.1 after taking ∞ -groupoid cores, but it is unclear to us how to obtain the actual statement from this information.

By contrast, our more elaborate proof of Theorem A.1 below also makes use of intermediate steps of Toën’s results (and the strategy applies equally well in the situation of [BGN18]).

In the proof, we will make use of two tangential results. For the first, recall that $f : A \rightarrow B$ is called a *faithful* functor if each $\text{Hom}_A(a, b) \rightarrow \text{Hom}_B(f(a), f(b))$ is an inclusion of path components, or equivalently, if hf is faithful and the commutative square

$$\begin{array}{ccc} A & \xrightarrow{f} & B \\ \downarrow & & \downarrow \\ \text{h}A & \xrightarrow{\text{h}f} & \text{h}B \end{array}$$

is cartesian.

Lemma A.4. *If $f : A \rightarrow B$ is faithful, then the diagram*

$$\begin{array}{ccc} \text{Fun}(C, A) & \longrightarrow & \text{Fun}(C, B) \\ \downarrow & & \downarrow \\ \text{Fun}(\text{h}C, \text{h}A) & \longrightarrow & \text{Fun}(\text{h}C, \text{h}B) \end{array}$$

is cartesian and, in particular, $f_ : \text{Fun}(C, A) \rightarrow \text{Fun}(C, B)$ is again faithful for any $C \in \text{Cat}$. If, furthermore, the restriction $\iota(A) \rightarrow \iota(B)$ is an inclusion of path components, then so is*

$$\iota(\text{Fun}(C, A)) \rightarrow \iota(\text{Fun}(C, B)).$$

Remark A.5. Note that the functor

$$\text{hFun}(C, A) \rightarrow \text{Fun}(\text{h}C, \text{h}A)$$

is not usually an equivalence, so the square of the lemma does not agree with the square

$$\begin{array}{ccc} \text{Fun}(C, A) & \longrightarrow & \text{Fun}(C, B) \\ \downarrow & & \downarrow \\ \text{hFun}(C, A) & \longrightarrow & \text{hFun}(C, B) \end{array}$$

which is cartesian if and only if f_* is faithful.

Proof of Lemma A.4. The first assertion is immediate from $\text{Fun}(\text{h}C, \text{h}B) \simeq \text{Fun}(C, \text{h}B)$ and the analogous assertion for A in place of B . The second assertion then follows, since the lower horizontal functor is clearly faithful, and faithful functors are closed under pullback. This is most easily seen from the characterisation that all induced maps on morphism complexes have empty or contractible fibres, which

is evidently stable under pullback. The third statement similarly follows from the analogue for ordinary categories by applying cores to the diagram of the lemma. \square

In the following, recall that a full subcategory $I \hookrightarrow C$ is said to be *dense* if the restricted Yoneda embedding $C \rightarrow \mathcal{P}(I)$ is fully faithful, or equivalently, if for each $c \in C$, the canonical map $\text{colim}_{i \in I/c} i \rightarrow c$ in C is an equivalence.

Lemma A.6. *Let \mathbf{X} be an $(\infty, 2)$ -category and $\text{Fun}(\mathbf{X}, \mathbf{Cat})$ the ∞ -category of 2-functors $\mathbf{X} \rightarrow \mathbf{Cat}$. For each $x \in \mathbf{X}$ and $A \in \mathbf{Cat}$, there exists an object $h_{x,A} \in \text{Fun}(\mathbf{X}, \mathbf{Cat})$ with the universal property*

$$\text{Hom}_{\text{Fun}(\mathbf{X}, \mathbf{Cat})}(h_{x,A}, F) \simeq \text{Hom}_{\mathbf{Cat}}(A, F(x)). \tag{A.7}$$

The full subcategory $\Delta_{\mathbf{X}} \subseteq \text{Fun}(\mathbf{X}, \mathbf{Cat})$ spanned by all $h_{x,[k]}$ with $x \in \mathbf{X}$ and $k \geq 0$ then forms a dense subcategory.

Observation A.8. For any functor $f : \mathbf{X} \rightarrow \mathbf{Y}$, let $f_! : \text{Fun}(\mathbf{X}, \mathbf{Cat}) \rightarrow \text{Fun}(\mathbf{Y}, \mathbf{Cat})$ be the left adjoint to the restriction functor. By the universal property (A.7), this sends $h_{x,A}$ to $h_{f(x),A}$ and hence restricts to $f_! : \Delta_{\mathbf{X}} \rightarrow \Delta_{\mathbf{Y}}$.

Proof. Let us start by observing that by the enriched Yoneda lemma [Hi20, Proposition 6.2.7], these universal functors $h_{x,A}$ indeed exist and are given by

$$h_{x,A} = \text{Hom}_{\mathbf{X}}(x, -) \times A : \mathbf{X} \longrightarrow \mathbf{Cat}. \tag{A.9}$$

Moreover, Hinich’s results show that the ∞ -category $\text{Fun}(\mathbf{X}, \mathbf{Cat})$ can be described as that of \mathbf{X} -modules in \mathbf{Cat} (in the sense of algebras for a many-object module ∞ -operad whose underlying many-object algebra is the \mathbf{Cat} -enriched ∞ -category \mathbf{X}). From this description, it follows that $\text{Fun}(\mathbf{X}, \mathbf{Cat})$ admits all colimits, and so the inclusion $j : \Delta_{\mathbf{X}} \hookrightarrow \text{Fun}(\mathbf{X}, \mathbf{Cat})$ induces an adjoint pair $j_! : \mathcal{P}(\Delta_{\mathbf{X}}^{\text{op}}) \rightleftarrows \text{Fun}(\mathbf{X}, \mathbf{Cat}) : j^*$ and we have to verify that the counit map

$$j_! j^* F \simeq \text{colim}_{h_{x,[k]} \in \Delta_{\mathbf{X}}/F} h_{x,[k]} \longrightarrow F \tag{A.10}$$

is an equivalence for all F . We will prove this in increasing levels of generality.

First, suppose that $F = h_{y,A}$. In this case, we claim that there is a cofinal functor $h_y : \Delta/A \rightarrow \Delta_{\mathbf{X}}/h_{y,A}$ sending each $[k] \rightarrow A$ to $h_{y,[k]} \rightarrow h_{y,A}$. The result then follows from the fact that $A \mapsto h_{y,A}$ preserves colimits and that $A \simeq \text{colim}_{[k] \in \Delta/A} [k]$. To see that h_y is indeed cofinal, it suffices to verify that the natural map

$$\text{colim}_{[k] \in \Delta/A} \text{Hom}_{\text{Fun}(\mathbf{X}, \mathbf{Cat})}(h_{x,[n]}, h_{y,[k]}) \longrightarrow \text{Hom}_{\text{Fun}(\mathbf{X}, \mathbf{Cat})}(h_{x,[n]}, h_{y,A})$$

is an equivalence. From the universal property (A.7) and the explicit formula (A.9) for $h_{y,A}$, one sees that this map is equivalent to

$$\text{colim}_{[k] \in \Delta/A} \text{Hom}_{\mathbf{Cat}}([n], \text{Hom}_{\mathbf{X}}(y, x) \times [k]) \longrightarrow \text{Hom}_{\mathbf{Cat}}([n], \text{Hom}_{\mathbf{X}}(y, x) \times A).$$

Taking the constant factor $\text{Hom}_{\mathbf{Cat}}([n], \text{Hom}_{\mathbf{X}}(y, x))$ out of the colimit, one sees that this is an equivalence since $\Delta \hookrightarrow \mathbf{Cat}$ is a dense subcategory [Re01].

Next, note that the class of F for which (A.10) is an equivalence is closed under all colimits that are preserved by j^* . For example, one easily sees from the universal property (A.7) that j^* preserves all coproducts.

To conclude, we now write each functor F as the geometric realisation of a bar construction. More precisely, let us fix a set S and an essentially surjective functor $f: S \rightarrow \mathbf{X}$. The description of $\text{Fun}(\mathbf{X}, \text{Cat})$ as modules then gives a free/forgetful adjunction

$$f_! : \prod_S \text{Cat} \rightleftarrows \text{Fun}(\mathbf{X}, \text{Cat}) : f^*, \tag{A.11}$$

where f^* evaluates at each object in S . Note that f^* preserves all limits and colimits and detects equivalences, so that $(f_!, f^*)$ is a monadic adjunction. The left adjoint $f_!$ sends each $(A_s)_{s \in S} \in \text{Cat}$ to $\coprod_{s \in S} h_{s, A_s}$.

Any $F: \mathbf{X} \rightarrow \text{Cat}$ can now be written as the geometric realisation $F \simeq |B_\bullet|$, where $B_\bullet = \text{Bar}(f_!, f^* f_!, f^* F)$ is the usual bar resolution of F for the monadic adjunction (A.11). The functor j^* preserves these geometric realisations (i.e., for any $x \in \mathbf{X}$ and $k \geq 0$, the map $|\text{Hom}_{\text{Cat}}([k], B_\bullet(x))| \rightarrow \text{Hom}_{\text{Cat}}([k], F(x))$ is an equivalence). Indeed, up to equivalence, we may take $x = f(s)$, in which case this follows from the augmented simplicial object $f^* B_\bullet \rightarrow f^* F$ having extra degeneracies [Lu17, Example 4.7.2.7]. Since each term in the bar construction is a coproduct of functors of the form $h_{f(s), A}$, for which we have already verified that the counit map (A.10) is an equivalence, it follows that (A.10) is an equivalence for F as well. \square

Proof of Theorem A.1. We will spell out the case of \mathcal{F} and discuss the modifications required for \mathcal{F}_{Gpd} and $\mathcal{F}_{\text{Gray}}$ at the end of the proof. \square

Step 1: reducing to simplices

Recall that precomposition with the localisation $\text{ac}: \text{sGpd} \rightarrow \text{Cat}$ gives a fully faithful embedding

$$\text{Fun}(\text{Cat}^{\text{op}} \times \text{Cat}^{\text{op}}, X) \rightarrow \text{Fun}(\text{sGpd}^{\text{op}} \times \text{sGpd}^{\text{op}}, X)$$

for any ∞ -category X . Since ac preserves colimits, this inclusion furthermore preserves the property of commuting with small limits in each variable separately, and on the right, the full subcategory spanned by such functors is equivalent to $\text{Fun}(\Delta^{\text{op}} \times \Delta^{\text{op}}, X)$. Since $\mathcal{F}: \text{Cat}^{\text{op}} \times \text{Cat}^{\text{op}} \rightarrow \text{CAT}$ does indeed preserve small limits in each variable, we find that $\text{Aut}(\mathcal{F})$ agrees with the automorphisms of the (large) bisimplicial ∞ -category $\mathcal{F}_{|\Delta^2}$ given by $(n, m) \mapsto \text{Fun}([n] \times [m], \text{Cat})$, with functoriality arising from restriction.

Step 2: restricting to generators

Note that $\mathcal{F}_{|\Delta^2}$ takes values in the subcategory Pr^{R} of CAT consisting of presentable ∞ -categories and right adjoint functors. Although the inclusion $\text{Pr}^{\text{R}} \subseteq \text{CAT}$ is not fully faithful, it does induce a fully faithful map on ∞ -groupoid cores, and by Lemma A.4, this feature persists to simplicial objects. We may therefore compute the automorphisms of $\mathcal{F}_{|\Delta^2}$ as a bisimplicial object in Pr^{R} instead.

From the equivalence $\text{Pr}^{\text{R}} \simeq (\text{Pr}^{\text{L}})^{\text{op}}$, given by taking adjoints, we find

$$\text{Fun}(\Delta^{\text{op}} \times \Delta^{\text{op}}, \text{Pr}^{\text{R}}) \simeq \text{Fun}(\Delta \times \Delta, \text{Pr}^{\text{L}})^{\text{op}}.$$

By another application of Lemma A.4, it follows that $\text{Aut}(\mathcal{F}_{|\Delta^2}) \simeq \text{Aut}(\mathcal{G})$, where \mathcal{G} denotes the (large) bicosimplicial ∞ -category

$$(n, m) \mapsto \text{Fun}([n] \times [m], \text{Cat})$$

with functoriality arising by left Kan extension.

Now consider the dense subcategories $\mathcal{H}(n, m) = \Delta_{[n] \times [m]} \subseteq \mathcal{G}(n, m)$ from Lemma A.6. By Observation A.8, every induced map on homotopy categories $\text{h}\mathcal{G}(n, m) \rightarrow \text{h}\mathcal{G}(n', m')$ carries $\text{h}\mathcal{H}(n, m)$

into $\mathbf{h}\mathcal{H}(n', m')$. In fact, $\mathcal{H}(n, m)$ coincides with the full subcategory spanned by the images of $\mathbf{\Delta} \subseteq \mathbf{Cat} = \mathcal{G}(0, 0)$ under all structure maps $\mathcal{G}(0, 0) \rightarrow \mathcal{G}(n, m)$. Since there are pullbacks

$$\begin{array}{ccc} \mathcal{H}(n, m) & \longrightarrow & \mathcal{G}(n, m) \\ \downarrow & & \downarrow \\ \mathbf{h}\mathcal{H}(n, m) & \longrightarrow & \mathbf{h}\mathcal{G}(n, m), \end{array}$$

it follows from the functoriality of pullbacks that the $\mathcal{H}(n, m)$ assemble into a functor $\mathbf{\Delta}^2 \rightarrow \mathbf{Cat}$ equipped with a natural transformation $\mathcal{H} \rightarrow \mathcal{G}$.

Let us now consider the induced maps

$$\mathrm{Hom}_{\mathbf{c}^2\mathbf{P}^{\perp}}(\mathcal{G}, \mathcal{G}) \longrightarrow \mathrm{Hom}_{\mathbf{c}^2\mathbf{CAT}}(\mathcal{H}, \mathcal{G}) \longleftarrow \mathrm{Hom}_{\mathbf{c}^2\mathbf{Cat}}(\mathcal{H}, \mathcal{H}).$$

We claim that both are inclusions of path components. To see this, note that the universal property of $\mathcal{P}(\mathcal{H}(n, m))$ as the free cocompletion of $\mathcal{H}(n, m)$ produces a natural transformation $\mathcal{P}(\mathcal{H}) \rightarrow \mathcal{G}$. By Lemma A.6, this exhibits each $\mathcal{G}(n, m)$ as a (left Bousfield) localisation of $\mathcal{P}(\mathcal{H}(n, m))$ for each $(n, m) \in \mathbf{\Delta}^2$. Consequently, writing out the terms as ∞ -groupoids of natural transformations and applying [GHN17, Proposition 5.1], we find

$$\begin{aligned} \mathrm{Hom}_{\mathbf{c}^2\mathbf{P}^{\perp}}(\mathcal{G}, \mathcal{G}) &\simeq \lim \mathrm{Hom}_{\mathbf{P}^{\perp}}(\mathcal{G}(n, m), \mathcal{G}(n', m')) \\ &\subseteq \lim \mathrm{Hom}_{\mathbf{P}^{\perp}}(\mathcal{P}(\mathcal{H}(n, m)), \mathcal{G}(n', m')) \\ &\simeq \lim \mathrm{Hom}_{\mathbf{CAT}}(\mathcal{H}(n, m), \mathcal{G}(n', m')) \\ &\simeq \mathrm{Hom}_{\mathbf{c}^2\mathbf{CAT}}(\mathcal{H}, \mathcal{G}), \end{aligned}$$

where the limits run over $[f: (n, m) \rightarrow (n', m')] \in \mathrm{Tw}^r(\mathbf{\Delta} \times \mathbf{\Delta})$. The second term is a set of path components in the third; indeed, this is so before taking limits, so that the fibre over a point in the target is the limit of a diagram only taking values \emptyset and $*$, and thus also either empty or contractible itself. Similarly, we find

$$\begin{aligned} \mathrm{Hom}_{\mathbf{c}^2\mathbf{Cat}}(\mathcal{H}, \mathcal{H}) &\simeq \lim \mathrm{Hom}_{\mathbf{Cat}}(\mathcal{H}(n, m), \mathcal{H}(n', m')) \\ &\subseteq \lim \mathrm{Hom}_{\mathbf{CAT}}(\mathcal{H}(n, m), \mathcal{G}(n', m')) \\ &\simeq \mathrm{Hom}_{\mathbf{c}^2\mathbf{CAT}}(\mathcal{H}, \mathcal{G}). \end{aligned}$$

Now notice that any automorphism φ of \mathcal{G} preserves the sub-diagram \mathcal{H} . Indeed, the induced automorphism on $\mathcal{G}(0, 0) = \mathbf{Cat}$ preserves the full subcategory $\mathbf{\Delta} \subseteq \mathbf{Cat}$ by [Lu09b, Corollary 4.4.11 & Proposition 4.4.13] and naturality with respect to left Kan extension and then implies that φ preserves the full subcategory $\mathcal{H}(n, m) \subseteq \mathcal{G}(n, m)$ as well. The inclusions of path components above therefore refine to inclusions of path components

$$\mathrm{Aut}(\mathcal{G}, \mathcal{G}) \subseteq \mathrm{Aut}(\mathcal{H}, \mathcal{H}) \subseteq \mathrm{Hom}_{\mathbf{c}^2\mathbf{CAT}}(\mathcal{H}, \mathcal{G}).$$

In particular, the claim that $\mathrm{Aut}(\mathcal{G}, \mathcal{G})$ is discrete with two components will follow from the analogous statement for \mathcal{H} .

Step 3: automorphism group of the generators

Recall that $\mathcal{H}(n, m)$ is spanned by the functors $h_{(i,j),[k]}$ for $(i, j) \in [n] \times [m]$ and $k \geq 0$, defined by the universal property (A.7) or by the explicit formula (A.9). The latter formula reduces to

$$h_{(i,j),[k]} : [n] \times [m] \longrightarrow \mathbf{Cat}, \quad (a, b) \longmapsto \begin{cases} [k] & a \geq i, b \geq j \\ \emptyset & \text{otherwise.} \end{cases}$$

Combined with (A.7), one sees that the mapping ∞ -groupoids between such functors are discrete and that there are equivalences

$$[n]^{\text{op}} \times [m]^{\text{op}} \times \Delta \xrightarrow{\sim} \mathcal{H}(n, m); \quad (i, j, [k]) \longmapsto h_{(i,j),[k]}.$$

In particular, the ∞ -categories $\mathcal{H}(n, m)$ are 0-truncated (i.e., equivalent to ordinary categories with discrete core); one can use this to conclude that the above equivalence is natural in (n, m) (which is now a property, rather than a structure), for the obvious functoriality on the left leaving Δ fixed.

Since all $\mathcal{H}(n, m)$ are 0-truncated, \mathcal{H} is a 0-truncated object in the ∞ -category of bicosimplicial ∞ -categories, and $\text{Aut}(\mathcal{H})$ is discrete. Furthermore, any automorphism of \mathcal{H} induces one on $\mathcal{H}(0, 0) = \Delta$, and this restriction determines the entire transformation: The composite

$$[n]^{\text{op}} \times [m]^{\text{op}} \times \Delta \xrightarrow{\varphi_{n,m}} [n]^{\text{op}} \times [m]^{\text{op}} \times \Delta \longrightarrow \Delta$$

is determined by naturality for the codegeneracy map $(n, m) \rightarrow (0, 0)$ and the composite

$$[n]^{\text{op}} \times [m]^{\text{op}} \times \Delta \xrightarrow{\varphi_{n,m}} [n]^{\text{op}} \times [m]^{\text{op}} \times \Delta \longrightarrow [n]^{\text{op}} \times [m]^{\text{op}}$$

by naturality with respect to the boundary maps $(0, 0) \rightarrow (n, m)$. Thus,

$$\text{Aut}(\mathcal{H}) \simeq \text{Aut}(\Delta) = \mathbb{Z}/2$$

as desired.

The other two cases

To conclude, we briefly describe the modifications to be made to the above argument to prove that \mathcal{F}_{Gpd} and $\mathcal{F}_{\text{Gray}}$ have trivial automorphism groups.

For \mathcal{F}_{Gpd} , we repeat the entire argument, but in Step 2 we use the natural subcategory $\mathcal{H}_{\text{Gpd}}(n, m) \subseteq \text{Fun}([n] \times [m], \text{Gpd})$ of diagrams of ∞ -groupoids given by left Kan extensions along $(i, j) : [0] \rightarrow [n] \times [m]$ of the constant diagram on the point. One then identifies the diagram \mathcal{H}_{Gpd} , with functoriality by left Kan extension, with the obvious diagram sending $(n, m) \mapsto [n]^{\text{op}} \times [m]^{\text{op}}$. This has trivial automorphisms.

For $\mathcal{F}_{\text{Gray}}$, one uses the dense subcategories $\mathcal{H}_{\text{Gray}}(n, m) = \Delta_{[n] \boxtimes [m]} \subseteq \text{Fun}([n] \boxtimes [m], \mathbf{Cat})$. Again, these full subcategories can also be characterised as those spanned by the essential images of Δ under all structure maps $\mathcal{G}_{\text{Gray}}(0, 0) \rightarrow \mathcal{G}_{\text{Gray}}(n, m)$. Formula (A.9) shows that the object $h_{(i,j),[k]}$ in $\mathcal{H}_{\text{Gray}}(n, m)$ is given by the 2-functor

$$h_{(i,j),[k]} : [n] \boxtimes [m] \longrightarrow \mathbf{Cat}, \quad (a, b) \longmapsto \text{Hom}_{[n] \boxtimes [m]}((i, j), (a, b)) \times [k].$$

The explicit description of the Gray tensor product (7.4) (see [HHLN23, Proposition 5.1.9]) identifies the mapping ∞ -category $\text{Hom}_{[n] \boxtimes [m]}((i, j), (a, b))$ with the poset of maximal chains from (i, j) to

(a, b) in the grid $[n] \times [m]$, ordered using that for each square, ‘right-after-down’ is smaller than ‘down-after-right’. Using this and the equivalence (A.7) to compute mapping ∞ -groupoids, one readily sees that each $\mathcal{H}_{\text{Gray}}(n, m)$ is a 0-truncated ∞ -category. This already implies that $\text{Aut}(\mathcal{H}_{\text{Gray}})$ is discrete, so it remains to verify that it has only one component.

To see this, consider the fully faithful functor (which we only need for gaunt 2-categories)

$$\Phi: \text{Cat}_2 \longrightarrow \text{Cart}(\Delta)$$

defined as follows: for each $(\infty, 2)$ -category \mathbf{C} and $[k] \in \Delta$, let $\Phi(\mathbf{C})_k$ be the ∞ -category obtained by applying the monoidal functor $\text{Hom}_{\text{Cat}}([k], -): \text{Cat} \longrightarrow \text{Gpd}$ to each mapping object. By naturality in $[k]$, this defines a simplicial diagram of ∞ -categories, whose underlying simplicial diagram of ∞ -groupoids of objects is constant; we define $\Phi(\mathbf{C}) \longrightarrow \Delta$ to be the cartesian unstraightening of this simplicial diagram of ∞ -categories. Unraveling the definitions then shows that the codegeneracy map $\mathcal{H}_{\text{Gray}}(n, m) \longrightarrow \mathcal{H}_{\text{Gray}}(0, 0) \cong \Delta$ can be identified with the cartesian fibration between 0-truncated ∞ -categories $\Phi([n] \boxtimes [m]) \longrightarrow \Delta$ (naturally in $[n]$ and $[m]$).

Let us now consider the map of sets $\text{Aut}(\mathcal{H}_{\text{Gray}}) \longrightarrow \text{Aut}(\mathcal{H}_{\text{Gray}}(0, 0))$ restricting an automorphism φ of $\mathcal{H}_{\text{Gray}}$ to the component $\varphi_{0,0}$. For an automorphism ψ of $\mathcal{H}_{\text{Gray}}(0, 0)$, the fibre $\text{Aut}(\mathcal{H}_{\text{Gray}})_{\psi}$ can be identified with the set of isomorphisms

$$\mathcal{H}_{\text{Gray}} \longrightarrow \psi^* \mathcal{H}_{\text{Gray}}$$

of bicosimplicial diagrams in the over- ∞ -category $\text{Cat}/\mathcal{H}_{\text{Gray}}(0, 0)$. By the above discussion, \mathcal{H} actually determines a cosimplicial diagram in the subcategory $\text{Cart}(\mathcal{H}_{\text{Gray}}(0, 0)) \subseteq \text{Cat}/\mathcal{H}_{\text{Gray}}(0, 0)$. By Lemma A.4, it then suffices to compute the sets of isomorphisms $\mathcal{H}_{\text{Gray}} \longrightarrow \psi^* \mathcal{H}_{\text{Gray}}$ within $\text{Cart}(\mathcal{H}_{\text{Gray}}(0, 0))$.

Identifying $\mathcal{H}(0, 0) \cong \Delta$, it now suffices to compute the set of isomorphisms of bicosimplicial diagrams in $\text{Cart}(\Delta)$

$$\Phi([-] \boxtimes [-]) \longrightarrow \psi^* \Phi([-] \boxtimes [-])$$

for all $\psi \in \text{Aut}(\Delta) \cong \{\text{id}, \text{op}\}$. Since $\Phi: \text{Cat}_2 \longrightarrow \text{Cart}(\Delta)$ is fully faithful (at least on gaunt 2-categories), this comes down to computing the sets of natural isomorphisms

$$\varphi: [n] \boxtimes [m] \longrightarrow [n] \boxtimes [m] \quad \text{and} \quad \varphi': [n] \boxtimes [m] \longrightarrow ([n] \boxtimes [m])^{2\text{-op}}.$$

Since such isomorphisms are determined by their behaviour on objects, compatibility with the vertex inclusions shows that there is a unique natural φ (the identity) and no natural φ' . We conclude that $\text{Aut}(\mathcal{H}_{\text{Gray}}) \subseteq \text{Aut}(\mathcal{H}_{\text{Gray}}) \simeq *$.

Acknowledgements. It is a pleasure to thank Dustin Clausen, Emanuele Dotto, Yonatan Harpaz, Gijsbert Scheltus Karel Sebastian Heuts, Corina Keller, Achim Krause, Markus Land, Denis Nardin, Thomas Nikolaus, Stefan Schwede, Wolfgang Steimle and Lior Yanovski for several very useful discussions. We further thank Shaul Barkan and Jan Steinebrunner for pointing out an omission in the verification of orthogonality for the factorisation system on span categories in the original version of this paper.

Competing interest. The authors have no competing interest to declare.

Funding statement. During the preparation of this text, FH and SL were members of the Hausdorff Center for Mathematics at the University of Bonn funded by the German Research Foundation (DFG), and FH was furthermore a member of the cluster ‘Mathematics Münster: Dynamics–Geometry–Structure’ at the University of Münster under grant nos. EXC 2047 and EXC 2044, respectively. FH would also like to thank the Mittag-Leffler Institute for its hospitality during the research program ‘Higher Algebraic Structures in Algebra, Topology and Geometry’, supported by the Swedish Research Council (VR) under grant no. 2016-06596. FH and JN were further supported by the European Research Council (ERC) through the grants ‘Moduli Spaces, Manifolds and Arithmetic’, grant no. 682922, and ‘Derived Symplectic Geometry and Applications’, grant no. 768679, respectively. SL was supported by the DFG Schwerpunktprogramm 1786 ‘Homotopy Theory and Algebraic Geometry’ (project ID SCHW 860/1-1).

References

- [AF20] D. Ayala and J. Francis, ‘Fibrations of ∞ -categories’, *High. Struct.* **4**(1) (2020), 168–265.
- [AGS23] F. Abellán García and W. Stern, ‘Enhanced twisted arrow categories’, *Theory Appl. Categ.* **39**(4) (2023), 98–149.
- [Ba13] C. Barwick, ‘On the Q-construction for exact quasicategories’, Preprint, 2013, [arXiv:1301.4725v2](https://arxiv.org/abs/1301.4725v2).
- [Ba17] C. Barwick, ‘Spectral Mackey functors and equivariant algebraic K-theory I’, *Adv. Math.* **304** (2017), 646–727.
- [BGN18] C. Barwick, S. Glasman and D. Nardin, ‘Dualizing cartesian and cocartesian fibrations’, *Theory Appl. Categ.* **33**(4) (2018), 67–94.
- [BGT13] A. J. Blumberg, D. Gepner and G. Tabuada, ‘A universal characterization of higher algebraic K-theory’, *Geom. Topol.* **17**(2) (2013), 733–838.
- [BH21] T. Bachmann and M. Hoyois, ‘Norms in motivic homotopy theory’, *Astérisque* **425** (2021), 1–207.
- [BMS21] S. Ben Moshe and T. Schlank, ‘Higher semiadditive algebraic K-theory and redshift’, Preprint, 2021, To appear in *Compositio Math.*, [arXiv:2111.10203v1](https://arxiv.org/abs/2111.10203v1).
- [BSP21] C. Barwick, and C. Schommer-Pries, ‘On the unicity of the homotopy theory of higher categories’, *J. Amer. Math. Soc.* **34** (2021), 1011–1058.
- [CDH+20] B. Calmès, E. Dotto, Y. Harpaz, F. Hebestreit, M. Land, K. Moi, D. Nardin, T. Nikolaus and W. Steimle, ‘Hermitian K-Theory of stable ∞ -categories II: Cobordism categories and additivity’, Preprint, 2020, [arXiv:2009.07224v3](https://arxiv.org/abs/2009.07224v3).
- [CDH+23] B. Calmès, E. Dotto, Y. Harpaz, F. Hebestreit, M. Land, K. Moi, D. Nardin, T. Nikolaus and W. Steimle, ‘Hermitian K-Theory of stable ∞ -categories I: Foundations’, *Selecta Math.* **29**(1) (2023), article no. 10.
- [CØJ21] D. Clausen and M. Ørsnes Jansen, ‘The reductive Borel-Serre compactification as a model for unstable algebraic K-theory’, Preprint, 2021, [arXiv:2108.01924v1](https://arxiv.org/abs/2108.01924v1).
- [Cr11] J. Cranch, ‘Algebraic theories, span diagrams and commutative monoids in homotopy theory’, Preprint, 2011, [arXiv:1109.1598v1](https://arxiv.org/abs/1109.1598v1).
- [Dr71] A. W. M. Dress, *Notes on the Theory of Representations of Finite Groups. Part I: The Burnside Ring of a Finite Group and some AGN-applications* (Universität Bielefeld, 1971).
- [EH20] E. Elmanto and R. Haugseng, ‘On distributivity in higher algebra I: The universal property of bispanns’, *Compositio Math.* **159**(2023), 2326–2415.
- [GHL21] A. Gagna, Y. Harpaz and E. Lanari, ‘Gray tensor products and lax functors of $(\infty, 2)$ -categories’, *Adv. Math.* **391** (2021), article no. 107986.
- [GHN17] D. Gepner, R. Haugseng and T. Nikolaus, ‘Lax colimits and free fibrations in ∞ -categories’, *Doc. Math.* **22** (2017), 1225–1266.
- [Ha18] R. Haugseng, ‘Iterated spans and classical topological field theories’, *Math. Z.* **289**(3–4) (2018), 1427–1488.
- [Ha20a] Y. Harpaz, ‘Ambidexterity and the universality of finite spans’, *Proc. Lond. Math. Soc.* **121**(5) (2020), 1121–1170.
- [Ha20b] R. Haugseng, ‘A fibrational mate correspondence for ∞ -categories’, Preprint, 2020, [arXiv:2011.08808v1](https://arxiv.org/abs/2011.08808v1).
- [Ha21] R. Haugseng, ‘On lax transformations, adjunctions, and monads in $(\infty, 2)$ -categories’, *High. Struct.* **5**(1) (2021), 244–281.
- [HHLN23] R. Haugseng, F. Hebestreit, S. Linskens and J. Nuiten, ‘Lax monoidal adjunctions, two-variable fibrations and the calculus of mates’, *Proc. Lond. Math. Soc.* **127**(4) (2023), 889–957
- [Hi20] V. Hinich, ‘Yoneda lemma for enriched ∞ -categories’, *Adv. Math.* **367**(107129) (2020), article no. 107129.
- [HLAS16] H. Heine, A. Lopez-Avila and M. Spitzweck, ‘ ∞ -categories with duality and hermitian multiplicative ∞ -loop space machines’, Preprint, 2016, [arXiv:1610.1004v2](https://arxiv.org/abs/1610.1004v2).
- [HLN20] F. Hebestreit, S. Linskens and J. Nuiten, ‘Orthofibrations and monoidal adjunctions’, Preprint, 2020, [arXiv:2011.11042v1](https://arxiv.org/abs/2011.11042v1).
- [HMS22] R. Haugseng, V. Melani and P. Safronov, ‘Shifted isotropic correspondences’, *J. Inst. Math. Jussieu* **21**(3) (2022), 785–849.
- [HNP17] Y. Harpaz, J. Nuiten and M. Prasma, ‘Quillen cohomology for $(\infty, 2)$ -categories’, *High. Struct.* **3**(1) (2019), 17–66.
- [HS21] F. Hebestreit and W. Steimle, ‘Stable moduli spaces of hermitian forms’, Preprint, 2021, [arXiv:2103.13911v2](https://arxiv.org/abs/2103.13911v2).
- [Jo08] A. Joyal, *The Theory of Quasi-Categories and Its Applications* (2008), <https://ncatlab.org/nlab/files/JoyalTheoryOfQuasiCategories.pdf>.
- [JT07] A. Joyal and M. Tierney, ‘Quasi-categories vs Segal spaces’, *Contemp. Math.* **431** (2007), 277–326.
- [La19] E. Lanari, ‘Cartesian factorization systems and pointed cartesian fibrations of ∞ -categories’, *High. Struct.* **5**(1) (2021), 1–17.
- [Lu09a] J. Lurie, *Higher Topos Theory (Annals of Mathematics Studies)* vol. **170** (Princeton University Press, 2009).
- [Lu09b] J. Lurie, ‘ $(\infty, 2)$ -categories and the Goodwillie calculus I’, (2009). <https://www.math.ias.edu/lurie/papers/GoodwillieI.pdf>.
- [Lu17] J. Lurie, ‘Higher algebra’, (2017). <https://www.math.ias.edu/lurie/papers/HA.pdf>.
- [MG19] A. Mazel-Gee, ‘The universality of the Rezk nerve’, *Algebr. Geom. Topol.* **19**(7) (2019), 3217–3260.
- [Na16] D. Nardin, ‘Parametrized higher category theory and higher algebra: Exposé IV – Stability with respect to an orbital ∞ -category’, Preprint, 2016, [arXiv:1608.07704v4](https://arxiv.org/abs/1608.07704v4).
- [Qu73] D. Quillen, ‘Higher K-theories’, in *Higher Algebraic K-Theory I* (Lecture Notes in Mathematics) vol. **341** (Springer, 1973), 85–147.

- [Ra14] S. D. Raskin, ‘Chiral principal series categories’, Ph.D. dissertation (2014). <https://dash.harvard.edu/handle/1/12274305>.
- [Ra23] M. Ramzi, ‘An elementary proof of the naturality of the Yoneda embedding’, *Proc. Amer. Math. Soc.* **151**(2023), 4163–4171.
- [Re01] C. Rezk, ‘A model for the homotopy theory of homotopy theory’, *Trans. Amer. Math. Soc.* **353**(3) (2001), 973–1007.
- [Re10] C. Rezk, ‘A Cartesian presentation of weak n -categories’, *Geom. Topol.* **14**(1) (2010), 521–571.
- [RS19] G. Raptis and W. Steimle, ‘A cobordism model for Waldhausen K -theory’, *J. Lond. Math. Soc.* **99**(2) (2019), 516–534.
- [RV22] E. Riehl and D. Verity, *Elements of ∞ -Category Theory (Cambridge Studies in Advanced Mathematics)* vol. **194** (Cambridge University Press, 2022).
- [Sc10] M. Schlichting, ‘Hermitian K -theory of exact categories’, *J. K-Theory* **5**(1) (2010), 105–165.
- [St18] D. Stevenson, ‘Model structures for correspondences and bifibrations’, Preprint, 2018, [arXiv:1807.08226v1](https://arxiv.org/abs/1807.08226v1).
- [St22] J. Steinebrunner, ‘Locally (co)Cartesian fibrations as realisation fibrations and the classifying space of cospans’, *J. Lond. Math. Soc.* **106**(2) (2022), 1291–1318.
- [St21] W. Steimle, ‘An additivity theorem for cobordism categories’, *Algebr. Geom. Topol.* **21**(2) (2021), 601–646.
- [To05] B. Toën, ‘Vers une axiomatisation de la théorie des catégories supérieures’, *K-Theory* **34**(3) (2005), 233–263.
- [To20] T. Torii, ‘On quasi-categories of comodules and Landweber exactness’, in *Bousfield Classes and Ohkawa’s Theorem* (Springer Proceedings in Mathematics & Statistics) vol. **309** (Springer, 2020), 325–380.