

THE HISTORY OF VECTORCARDIOGRAPHY*

by

GEORGE E. BURCH**

Vectorcardiography (VCG) is a part of electrocardiography (ECG). The vectorcardiogram displays the various complexes of the electrocardiogram, i.e. QRS, P and T complexes, in the form of "loops" which are determined from vectors representing successive instantaneous mean electric forces from the heart throughout an entire cardiac cycle. Since the heart is a three-dimensional structure, the electric forces from the heart during each heartbeat are oriented three-dimensionally and, therefore, can be represented by a time sequence of vectors which display the magnitude and direction of these mean electric forces. Anyone who knows the fundamental and theoretical aspects of electrocardiography and knows clinical cardiology and employs electrocardiographs with high frequency response and good fidelity can visualize the detailed configuration of the vectorcardiogram from the electrocardiogram. The electrocardiogram displays the same information as the vectorcardiogram and even provides other information not readily available from the vectorcardiogram, especially temporal phenomena and disorders in cardiac rhythm. Nevertheless, vectorcardiography has developed as a result of the efforts of many investigators who were interested in the use of vector analysis of the cardiac electric potentials recorded from the surface of the body. Such investigations have contributed a great deal to a better understanding of electrocardiography and aspects of electrophysiology. Since the time sequence, magnitude, and spatial direction of the instantaneous mean vectors are determined by the order of depolarization and repolarization of the atria and ventricles which, in turn, are affected by the clinical state of the myocardium, it was considered that the spatial vectorcardiogram could be useful in learning more about the electrophysiology of the heart in normal and diseased states. There have been many reports in the field of vectorcardiography since its introduction (footnotes 1-79).

With the recent introduction of a direct-writing vectorcardiograph with good frequency response and fidelity, the use of and interest in vectorcardiography in clinical medicine have increased. Some of the original contributions to vectorcardiography are discussed below.

THE VECTOR CONCEPT IN ELECTROCARDIOGRAPHY

A vector is a mathematical representation which has direction, magnitude, and

*Presented at the Symposium on Developments in Electrocardiography in Leiden 28 October 1977.

**George E. Burch, MD, Department of Medicine of Tulane University School of Medicine and the Charity Hospital of Louisiana, New Orleans, Louisiana, USA,

Supported by the Cardiovascular Research Fund, the Rowell A. Billups Fund for Research in Heart Disease, and the Feazel Laboratory.

sense. The concept of representing the electric forces from the heart as recorded from the surface of the body of man as a vector force was first established by Einthoven, Fahr, and de Waart in 1913,¹ when they showed how the equilateral triangle of Einthoven could be used to obtain the mean electric axis of the QRS complex of the recorded electrocardiogram from standard limb leads I, II, and III. The mean vector as projected on to the frontal plane was nicely illustrated by them (fig. 1). The angle α of the vector indicated the direction of this mean vector, and its length indicated the mean magnitude. This was first demonstrated for the QRS complex, the electric force of depolarization of the ventricles. It was obvious that the same principles applied to the T wave, the electric force of repolarization of the ventricles, and to the P wave, the electric force of depolarization of the atria. These mean vector quantities with direction and magnitude as projected on to the frontal plane also indicate "sense". The "sense" indicated by the vector may be described by the fact that the vector is directed away from the area of greatest relative negativity of the electric force derived from the heart toward the area of greatest relative positivity. In general, the sense is rarely discussed and is taken for granted in the construction of the vector.

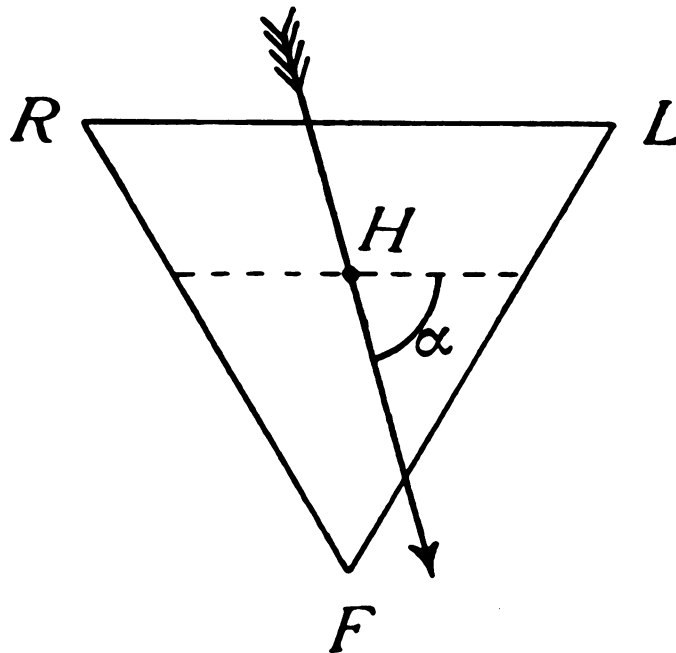


Figure 1. The method of obtaining the direction of the mean electric axis of the QRS complex described by Einthoven, Fahr, and de Waart using the equilateral triangle. (From W. Einthoven, G. Fahr, and A. de Waart, *Pflügers Arch. ges. Physiol.*, 1913, **150**: 275-315.)

¹ W. Einthoven, G. Fahr, and A. de Waart, 'Über die Richtung und die manifest Grösse der Potentialschwankungen im menschlichen Herzen und über den Einfluss der Herzlage auf die Form des Elektrokardiogramms', *Pflügers Arch. ges. Physiol.*, 1913 **150**: 275-315.

The history of vectorcardiography

About the same time and shortly prior to the introduction of the vector concept by Einthoven, Fahr and de Waart,¹ Waller² and Lewis³ were also concerned with the electric potentials *within* the heart. Waller had already introduced in 1889 the dipole concept (relatively negative and relatively positive electric fields) through surface mapping of isopotential lines. The line of zero potential and the isopotential lines are clearly shown in the illustration from Waller's report (fig. 2.) But, Einthoven and his associates indicated that a vector quantity could define the electric forces from the heart recorded on the surface of the body. Einthoven's law ($e_1 + e_3 = e_2$), derived from Gustav Kirchoff's second law of the flow of electric currents in a network, further contributed to early thinking in terms of vector quantities. Craib and Canfield⁴ also introduced general principles of cardiac electric physiology in terms of the dipole and doublet concept and vector analysis (fig. 3). That these vector quantities applied theoretically to sphere or cylinder is evident from fig. 4, as reported by Duchosal and Sulzer.⁵ Lewis, in 1916,³ indicated the local spread of the

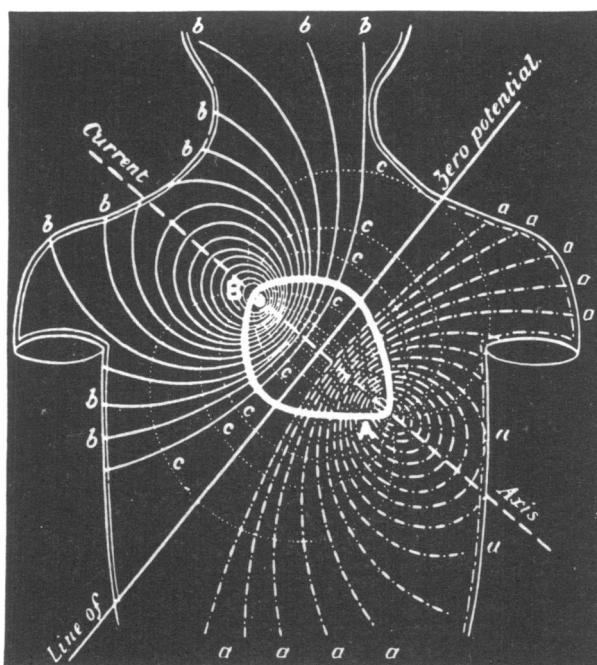


Figure 2. Isopotential lines mapped on the surface of the body by Waller using the capillary electrometer. This introduced the concept of the mean electric potential of the heart as a single dipole. (From Augustus D. Waller, *Phil. Trans. R. Soc. Lond.*, 1889, **180**: 169-194.)

¹ Augustus D. Waller, 'On the electromotive changes connected with the beat of the mammalian heart, and of the human heart in particular', *Phil. Trans. R. Soc. Lond.*, 1889, **180**: 169-194.

² Thomas Lewis, 'The spread of the excitatory process in the vertebrate heart', *ibid.*, 1916, **207**: 221-310.

³ W.H. Craib (with an appendix by R. Canfield), 'A study of the electrical field surrounding active heart muscle', *Heart*, 1927, **14**: 71-109.

⁴ Pierre W. Duchosal and Robert Sulzer, 'La vectorcardiographie: méthode d'exploration du champ électrique créé dans le corps humain par les courants d'action du coeur dans les conditions normales et pathologiques', *Cardiologia*, 1949, Supp. 3: 1-172.

waves of electric activation of the ventricles by small local vectors, as shown in fig. 5, Williams, in 1914,⁶ constructed a temporal series of vectors from the standard limb leads of the electrocardiogram (fig. 6). This report of Williams is an excellent early expression of the vectorcardiography concept as recorded from the electrocardiogram.

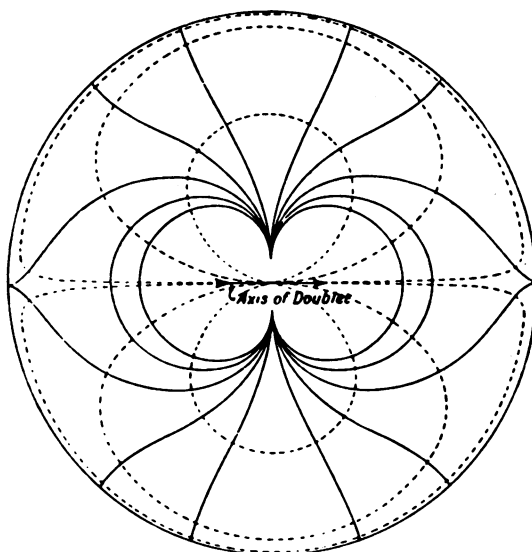


Figure 3. The electric field in the homogeneous spherical volume conductor created by a doublet, as introduced in electrocardiography by Craib and Canfield. (From W.H. Craib and R. Canfield, *Heart*, 1927, 14: 71-109.)

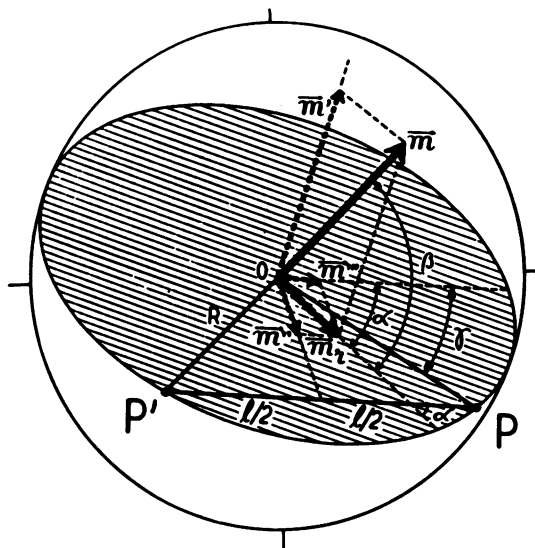


Figure 4. A vector expression of the electric potential differences on the surface of a homogeneous electrically conductive sphere. (From Pierre W. Duchosal and Robert Sulzer, *Cardiologia*, 1949, Supp. 3: 1-172.)

The history of vectorcardiography

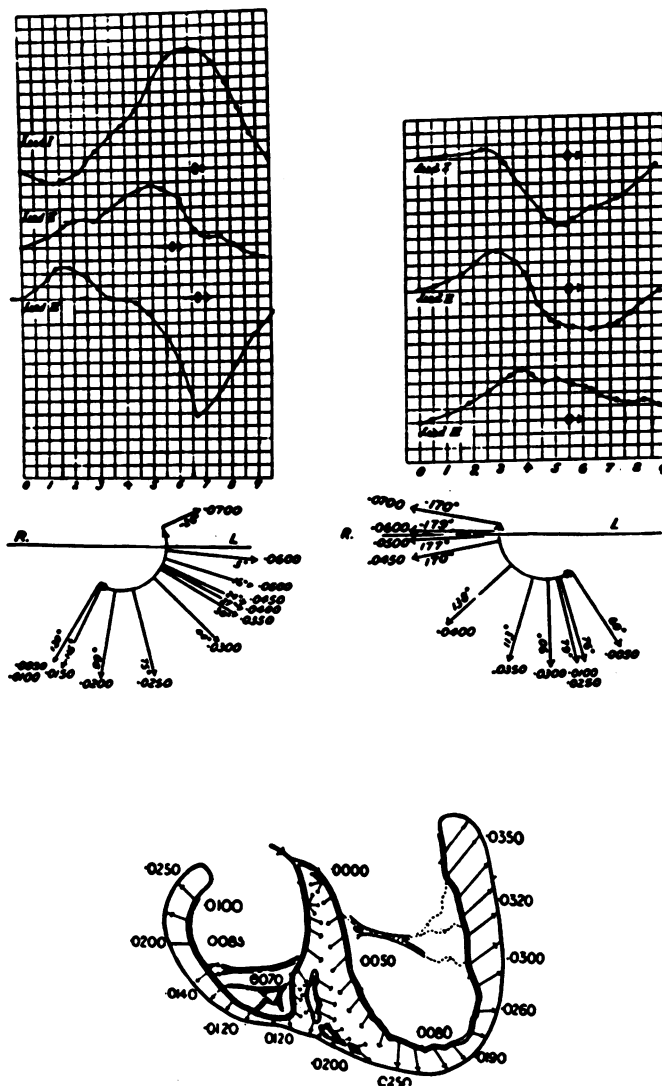


Figure 5. The upper part of this illustration represents a series of vectors constructed from the electrocardiogram by Lewis. This is one of the early efforts of presenting the time course of vector quantities during a single heartbeat in man. The lower part of this illustration is a frequently reproduced diagram of the times of appearance of the action potential for a single heartbeat at the surface of the ventricle. This was an important early contribution to vector analysis of the spread of activation in the heart. (From Thomas Lewis, *Phil. Trans. R. Soc. Lond.*, 1916, 207:221-310.)

⁶ Horatio B. Williams, 'On the cause of the phase difference frequently observed between homonymous peaks of the electrocardiogram' *Am. J. Physiol.*, 1914, 35: 292-300.

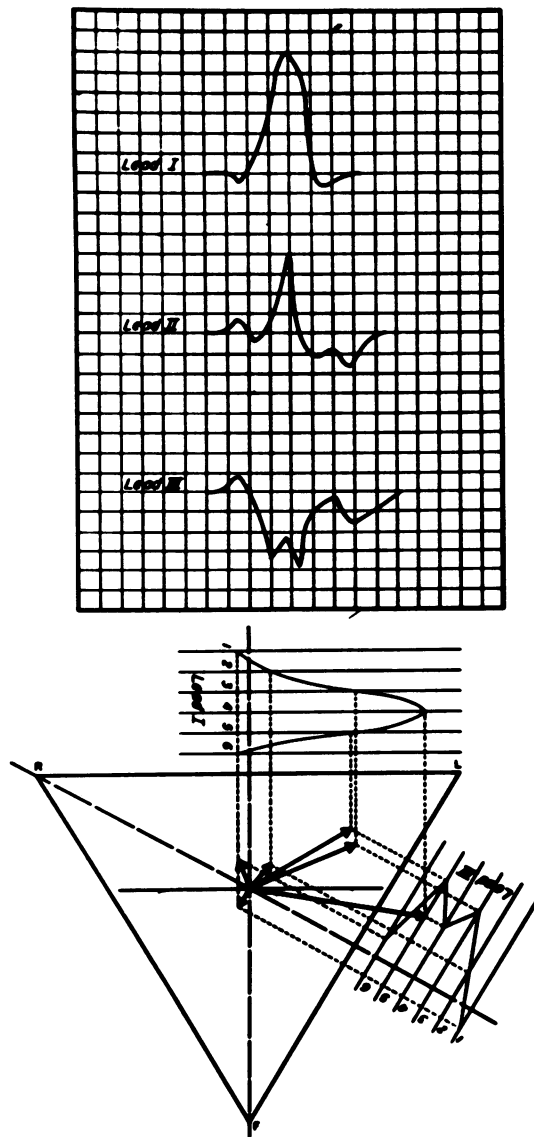


Figure 6. Calculation of the time course of the electric potentials as vector quantities for a single heartbeat obtained from leads I and III of the electrocardiogram. This is the first report indicating the technique for manually obtaining a “vectorcardiogram” from the standard limb leads. (From Horatio B. Williams, *Am. J. Physiol.*, 1914, 35: 292-300.)

THE MONOCARDIOGRAM

It was Mann who first introduced, in 1920, the concept of the “loop” to represent a continuous uninterrupted series of vectors to display as vector quantities the electric forces of depolarization and repolarization from the body surface recordings of the electric cardiac activity noted in the electrocardiogram.⁷ Mann obtained these

⁷ Hubert Mann, ‘A method of analyzing the electrocardiogram’, *Arch. intern. Med.*, 1920, 25: 283-294.

The history of vectorcardiography

“loops” by manually and tediously graphing a series of vectors (fig. 7) obtained by construction using the vector analysis principles first established by Einthoven, Fahr, and de Waart. Although this type of manual “loop” construction involved an extremely tedious, time-consuming process, some investigators employed this technique in their studies. Obviously, the constructed loops could only be approximations. Important details were not obtained. Mann named the resultant constructed “loop” the *monocardiogram* (MCG).^{7,8} He constructed it for the QRS only, since the QRS complexes recorded by the electrocardiogram provided adequate details for this type of analysis, whereas the magnitude of the other deflections and components of the electrocardiogram was too small for such analysis. Even as early as 1920, Mann referred to the “three dimensional view” and the “transverse monocardiogram” of the cardiac cycle. This was the first reference to what later became known as the “spatial vectorcardiogram” or “spatial VCG”. Mann’s publication of tables and illustrations readily reveals the extensive amount of work that was required to obtain a “loop” or monocardiogram merely for one QRS complex of a single heartbeat. Furthermore, to construct a loop which is somewhat representative of the type of vectorcardiogram recorded at present requires that at least two standard limb leads be recorded simultaneously. This could not be done by recorders available in Mann’s time. He and others who followed him had to attempt to align temporally the complexes of the respective leads as best and as rationally as

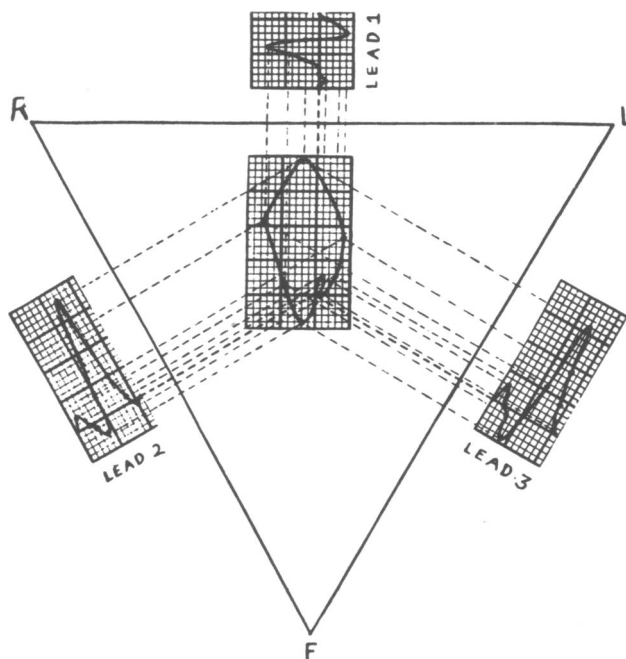


Figure 7. The first published “loop” of the vectorcardiogram constructed manually from the standard limb leads by Mann, which he named the monocardiogram. (From Hubert Mann, *Arch. intern. Med.*, 1920, 25: 283-294.)

⁸ H. Mann, ‘The monocardiograph’, *Am. Heart J.*, 1938, 15: 681-699.

possible. Even this procedure alone resulted in significant errors. Thus the “constructed” vectorcardiograms could only, at best, be approximations.

In 1920, Fahr⁹ was also seriously considering vector analysis of the electrocardiogram. Fahr referred to the “manifest” vectors as well as to the constructed mean vectors for any given moment as could be obtained from the equilateral triangle of Einthoven (fig. 8). Fahr also was aware that the mean vector varied during the cardiac cycle (figs. 9, 10). In 1929, Savjaloff studied vectors of electric cardiac activity in man and was concerned about the reference frame and electrode placement.¹⁰ He placed the electrodes on the head in an attempt to establish a network for reference (plate 1). His equilateral triangle of reference was upside down (fig. 11). He was the first to suggest the “cube” as a spatial or 3-dimensional reference frame for spatial vector analysis (fig. 12).

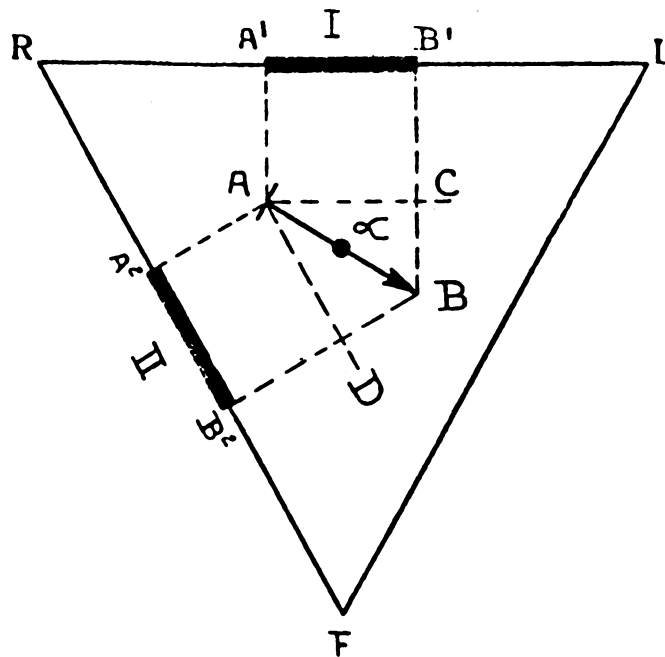


Figure 8. Projections of the mean vector of the electrocardiogram on the lead I and lead II axes of the equilateral triangle, as presented by Fahr in 1920. (From George Fahr, *Arch. intern. Med.*, 1920, 25: 146-173.)

⁹ George Fahr, ‘An analysis of the spread of the excitation wave in the human ventricle’, *Arch. intern. Med.*, 1920, 25: 146-173.

¹⁰ Vsevolod V. Savjaloff, ‘Methode der stereometrischen Elektrokardiographie’, *Zt. Kreislauff.*, 1929, 21: 705-716.

¹¹ H. Mann, ‘Interpretation of bundle-branch block by means of the monocardiogram’, *Am. Heart J.*, 1931, 6: 447-457.

The history of vectorcardiography

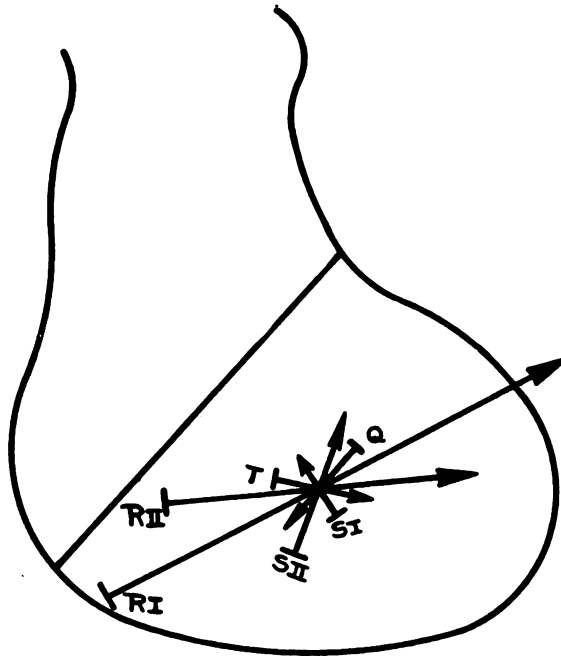


Figure 9. The electric potentials represented as mean vector quantities for the Q,R,S and T complexes of the electrocardiogram. This analysis of wave spread was suggested by Fahr in 1920. (From George Fahr, *Arch. intern. Med.*, 1920, 25: 146-173.)

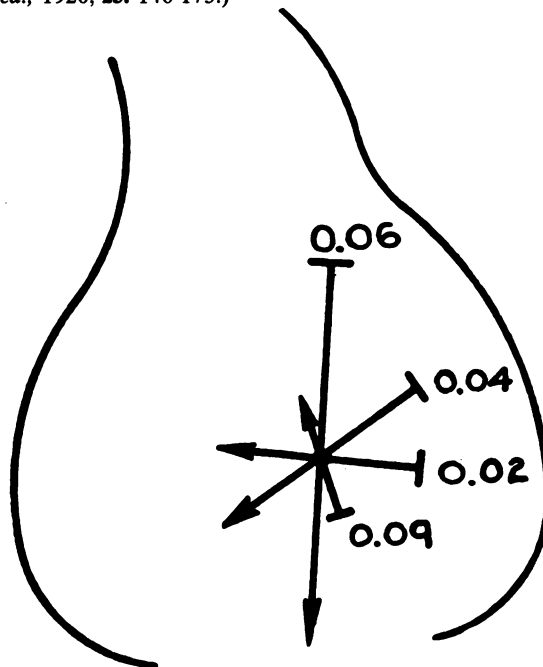


Figure 10. Serial vector quantities of the QRS complex during a single heartbeat as constructed manually by Fahr in 1920. (From George Fahr, *Arch. Intern. Med.*, 1920, 25: 146-173.)

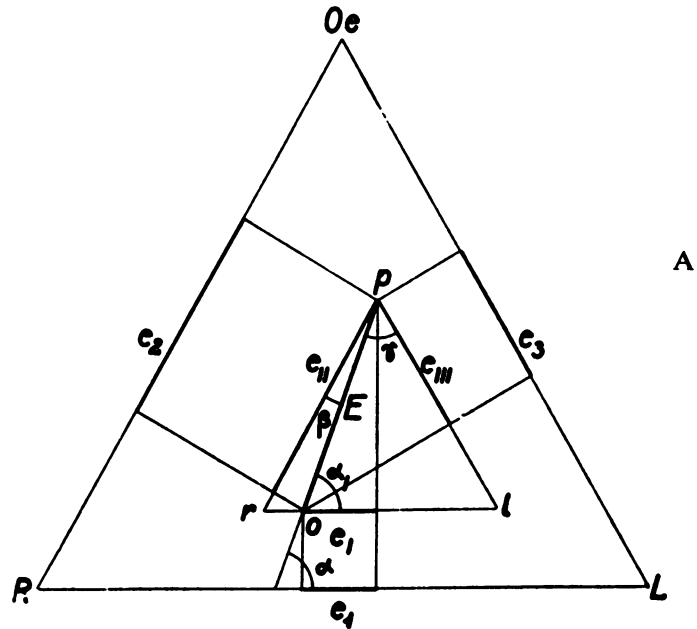


Abb. 4

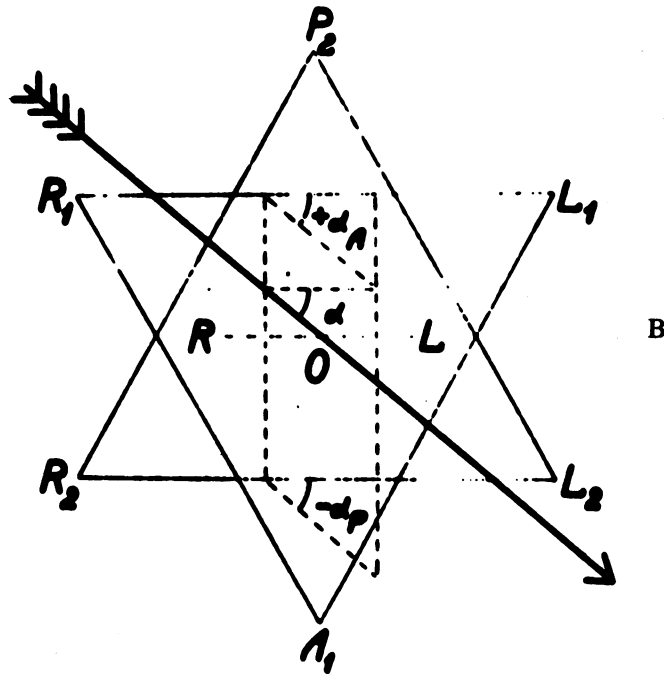


Figure 11. Electrode placement suggested by Savajaloff resulted in an upside-down equilateral triangle (see part A). As shown in part B, an effort was made by Savajaloff to analyse vector forces of the heart's electric potential to translate those obtained through the use of his equilateral triangle to the equilateral triangle of Einthoven. (From Vsevolod V. Savajaloff, *Zt. Kreislauff.*, 1929, 21: 705-716.)

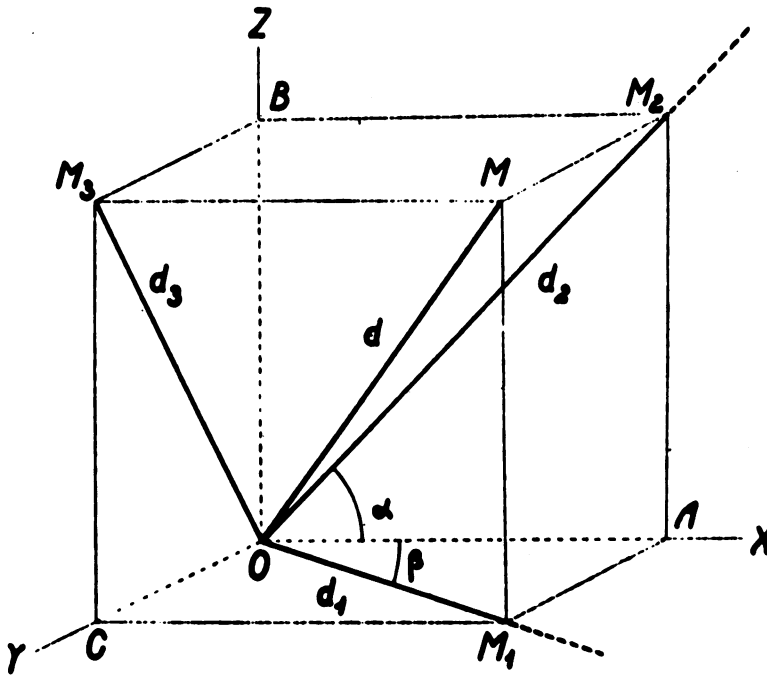


Figure 12. This illustration reveals an early effort by Savjaloff to consider the spatial orientation of the electric forces of the heart as spatial vector quantities. (From Vsevolod V. Savjaloff, *Zt. Kreislauff.*, 1929, 21: 705-716.)

In the meantime, Mann was still busily engaged in manually constructing monocardigrams in patients with various types of disease states and electrocardiographic abnormalities.¹¹ The resultant “loops” readily illustrated what could be expected from three standard limb leads as obtained for the frontal plane. These studies also revealed the potential of vectorcardiography in better visualizing aspects of theoretical electrocardiography. Unfortunately, the procedure was difficult and subject to error, and failed to demonstrate adequately important details of loop configuration and directions of rotation.

VECTORCARDIOGRAPHIC RECORDERS AND TECHNIQUES

Realizing the difficulties associated with construction of the “loop” manually Mann developed an apparatus for recording the monocardigram directly from the patient. Although the apparatus was developed in 1925, it was not described in the literature by Mann until 1938.⁸ It consisted of a mirror moved by three galvanometer coils which were activated by the 3 standard limb leads of the electrocardiogram (fig. 13). In 1936 and 1937, the most important technical advancement in vectorcardiography was reported. Schellong¹² in Germany; Wilson, Johnston, and Barker¹³ in the USA;

¹¹ F. Schellong, ‘Elektrographische Diagnostik der Herzmuskeler-krenkungen’, *Verhandl. Dt. Gesell. inn. Med.*, 1936, 48: 288-310.

¹³ Frank N. Wilson, Franklin D. Johnston, and Paul S. Barker. ‘The use of the cathode-ray oscillograph in the study of the monocardigram’, *J. clin. Invest.*, 1937, 16: 664-665.

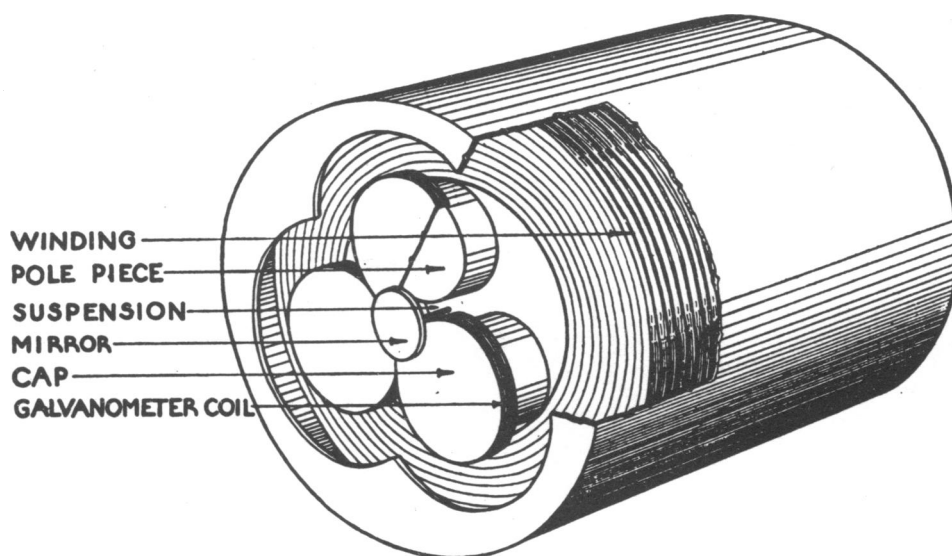


Figure 13. The mirror activated by three galvanometer coils devised by Mann to record the monocardium. This device was developed in 1925 and represents the first mechanical (not manual) recorder for vectorcardiography. (From Hubert Mann, *Am. Heart J.*, 1938, 15: 681-699.)

and Hollmann and Hollmann¹⁴ in Germany, described the use of the cathode ray oscilloscope for automatically and accurately recording the vectorcardiogram. These three groups of investigators conducted their studies independent of and without knowledge of each other's research activities. The use of the cathode ray oscilloscope was responsible for a significant change in the field of vectorcardiography.

It should be mentioned that Rijlant in Belgium, in 1936, reported studies of the spatial variations in electric potential of the heartbeat as recorded in the electrocardiogram from the body surface.^{15,16} He used the oscilloscope in these investigations, but he displayed the time-course of the spatial scalar electrocardiogram and not the vectorcardiogram or the spatial vectorcardiogram as Wilson and Schellong had done. These reports by Rijlant also were important contributions to the field of electrocardiography and vectorcardiography at that time.

The electric circuits used by Schellong, Wilson, and others and the cathode ray tube made it possible to record with high frequency response and high fidelity and continuously all loops of the vectorcardiogram. These recordings provided for the first time accurate vectorcardiograms. Although Mann had done fairly well with his mirror activated by three movable galvanometer coils, his mirror arrangement did

¹⁴ W. Hollmann and H.E. Hollmann, 'Neue elektrokardiographische Untersuchungsmethoden', *Zt. Kreislauff.*, 1937, 29: 546-558.

¹⁵ Pierre Rijlant, 'Introduction à l'étude de la distribution spatiale des variations de potentiel produites par le coeur chez l'homme', *C.r. Séanc. Soc. Biol., Paris*, 1936, 121: 1358-1361.

¹⁶ P. Rijlant, 'Mécanisme de l'envahissement de l'oreillette droite du coeur de mammifère par la contraction', *ibid.*, 1936, 121: 1361-1364.

The history of vectorcardiography

not have the frequency response of the cathode ray tube. The latter immediately became the universal method for accurate recordings of the vectorcardiogram.

The reference system used by Schellong and associates^{12,17,18} to obtain a three-dimensional tracing is shown in fig. 14. These investigators were the first to use constructed wire models of the vectorcardiogram in order to appreciate better the spatial orientation of the vectorcardiogram (fig. 15). Schellong's publication in 1936 was an outstanding early report on spatial vectorcardiography.¹² The reports of stereoscopic views of the spatial vectorcardiogram (fig. 16), which facilitated three-dimensional visualization of the vector loops, including the T loops, by Schellong and his associates were also important contributions. These investigators had solved very well the problems offered by the "halo" at the isopotential point of the recording. The "halo" is due to the fact that the cathode ray beam remains at one point on the cathode ray screen for a relatively long time. This results in an important technical problem in studies with the cathode ray oscilloscope.

Although Wilson, Johnston, and Barker presented their studies with the use of the cathode ray oscilloscope to record the vectorcardiogram in Atlantic City in the spring of 1937,¹³ their work was performed during 1936. They used the central terminal along with the standard limb lead electrode placement to obtain their recordings. The central terminal, which they introduced as the indifferent electrode for more reliable electrocardiographic recordings, is an extremely important point for electrode placement. In 1938, Wilson and Johnston¹⁹ described in detail the method they advocated for recording the frontal plane projection of the vectorcardiogram (figs. 17, 18, 19).

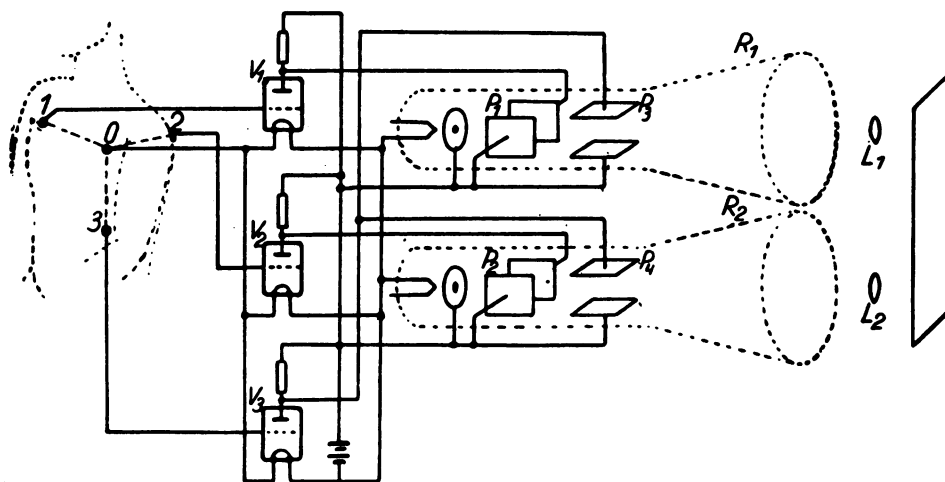


Figure 14. The circuit used for recording the vectorcardiogram with the cathode ray oscilloscope by Schellong. Schellong was the first to publish (1936) vectorcardiograms recorded with the cathode ray oscilloscope. (From F. Schellong, S. Heller, and E. Schwingel, *Zt. Kreislauff.*, 1937, 29: 497-509.)

¹⁷ F. Schellong, S. Heller, and E. Schwingel, 'Das Vektordiagramm; eine Untersuchungsmethode des Herzens', *Zt. Kreislauff.*, 1937, 29: 497-509.

¹⁸ F. Schellong and E. Schwingel, 'Das Vektordiagramm; eine Untersuchungsmethode des Herzens. II. Über die Bedeutung von Knotungen und Aufsplitterungen in QRS des Ekg', *ibid.*, 1937, 29: 596-607.

¹⁹ F. N. Wilson and F.D. Johnston, 'The vectorcardiogram', *Am. Heart J.*, 1938, 16: 14-28.

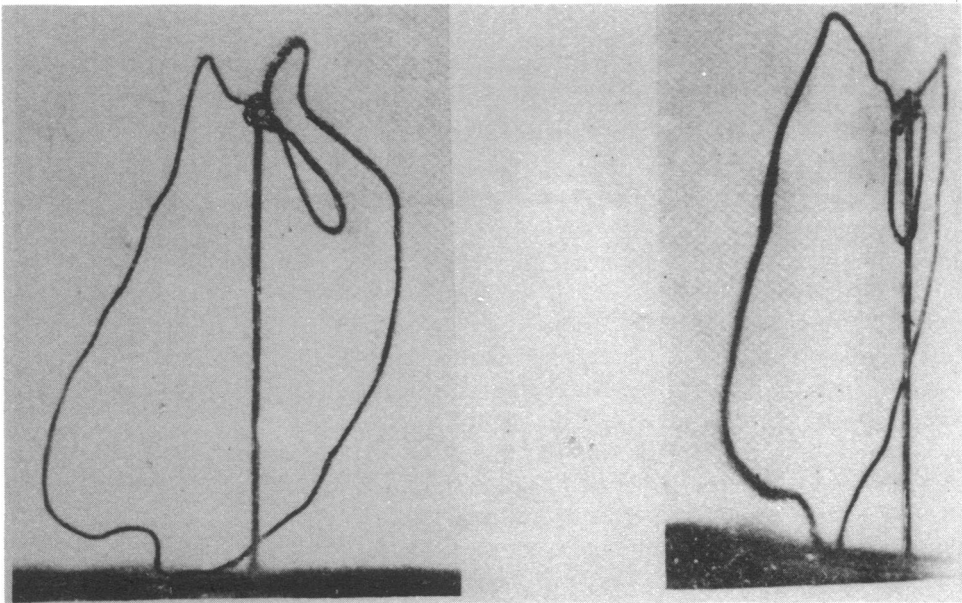


Figure 15. Wire loop models constructed by Schellong as early as 1937 in an effort to learn more about the spatial vectorcardiogram, a new type of recording in electrocardiography at that time. (From F. Schellong, S. Heller and E. Schwingel, *Zt. Kreislauff.*, 1937, 29: 497-509.)

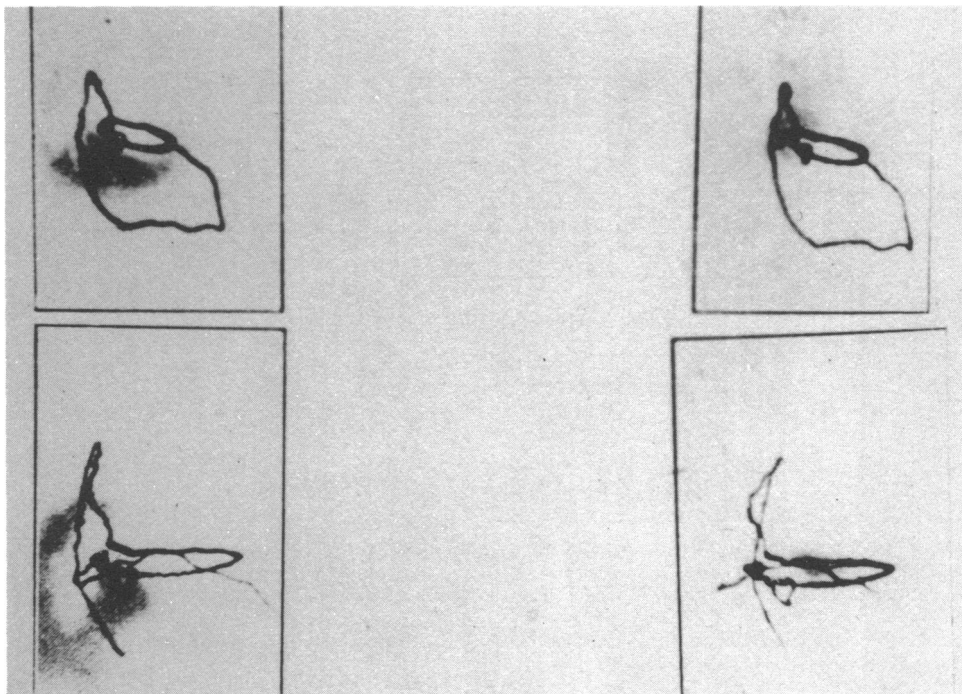


Figure 16. Stereo spatial vectorcardiograms as described by Schellong and Schwingel in 1937. (From F. Schellong and E. Schwingel, *Zt. Kreislauff.*, 1937, 29: 596-607.)

The history of vectorcardiography

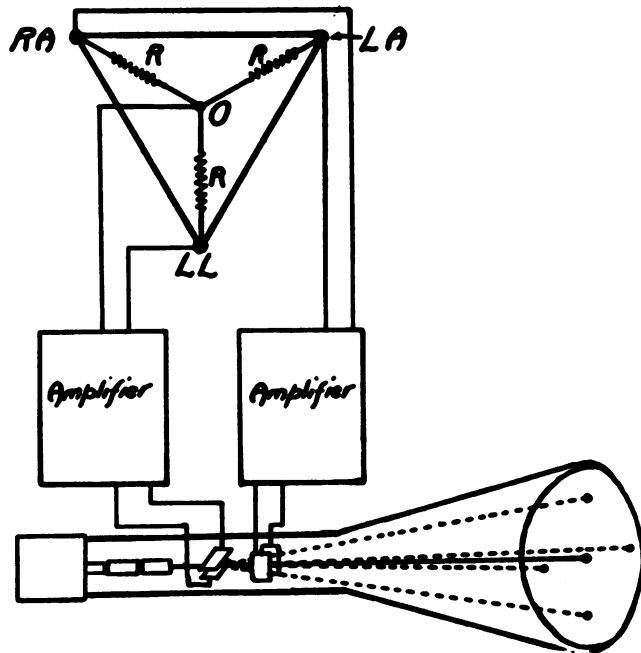


Figure 17. Diagram of the circuit used by Wilson and Johnston to record the vectorcardiogram by means of the cathode ray oscilloscope. (From Frank N. Wilson and Franklin D. Johnston, *Am. Heart J.*, 1938, 16: 14-28.)

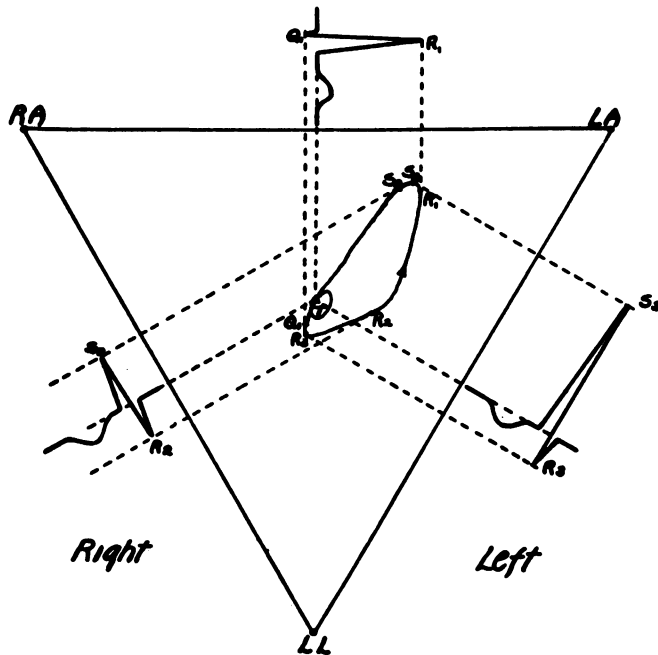


Figure 18. An illustration showing the relationship between the vectorcardiogram and the 3-standard-lead electrocardiogram, described by Wilson and Johnston. (From Frank N. Wilson and Franklin D. Johnston, *Am. Heart J.*, 1938, 16: 14-28.)

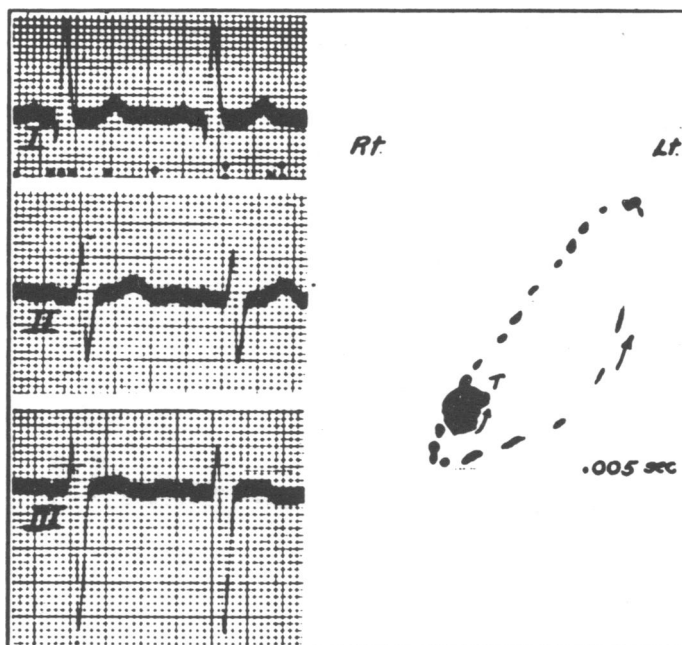


Figure 19. Actual recordings of the electrocardiogram and vectorcardiogram reported by Wilson and Johnston. These apparently are the same tracings as those shown diagrammatically in figure 18. (From Frank N. Wilson and Franklin D. Johnston, *Am. Heart J.*, 1938, 16: 14-28.)

Hollmann and Hollmann in 1937¹⁴ described their studies of the vectorcardiogram for the frontal plane projection and the use of the cathode ray oscilloscope (plate 2) to record the vectorcardiogram directly (fig. 20). Their apparatus is shown in plate 3. In 1938, these investigators published a study²⁰ using essentially the same type circuits as Wilson and his collaborators. Hollmann and Hollmann also introduced their technique for recording the stereovectorcardiogram (fig. 21). Their recordings were very good for those early days of vectorcardiography. These two investigators introduced the concept of the "scroll", i.e. continuous recording of the vectorcardiogram (fig. 22), in an attempt to record the time course of the cardiac rhythm and time intervals as well as the vectorcardiogram of successive and entire heartbeats. Mann, in 1938, also published continuous recordings of the vectorcardiogram using his system of three galvanometers which activated a mirror.⁸

A method was developed and described by us^{21,22} for recording stereoscopic views directly from two cathode-ray tubes using a simple electrode arrangement. This method made three-dimensional viewing of the sVCG easy, reliable, and accurately

²⁰ H.E. Hollmann and W. Hollmann, 'Das Einthovensche Dreiecksschema als Grundlage neuer elektrokardiographischer Registriermethoden', *Zt. klin. Med.*, 1938, 134: 732-753.

²¹ J.A. Cronvich, J.A. Abildskov, C.E. Jackson, and G.E. Burch, 'An approximate derivation for stereoscopic vectorcardiograms with the equilateral tetrahedron', *Circulation*, 1950, 2: 126-127.

²² G.E. Burch, J.A. Cronvich, J.A. Abildskov, and C.E. Jackson, 'A derivation for stereoscopic vectorcardiograms and analysis of vectorcardiograms by high-speed motion pictures', *Trans. Assoc. Am. Physns*, 1950, 63: 268-271.

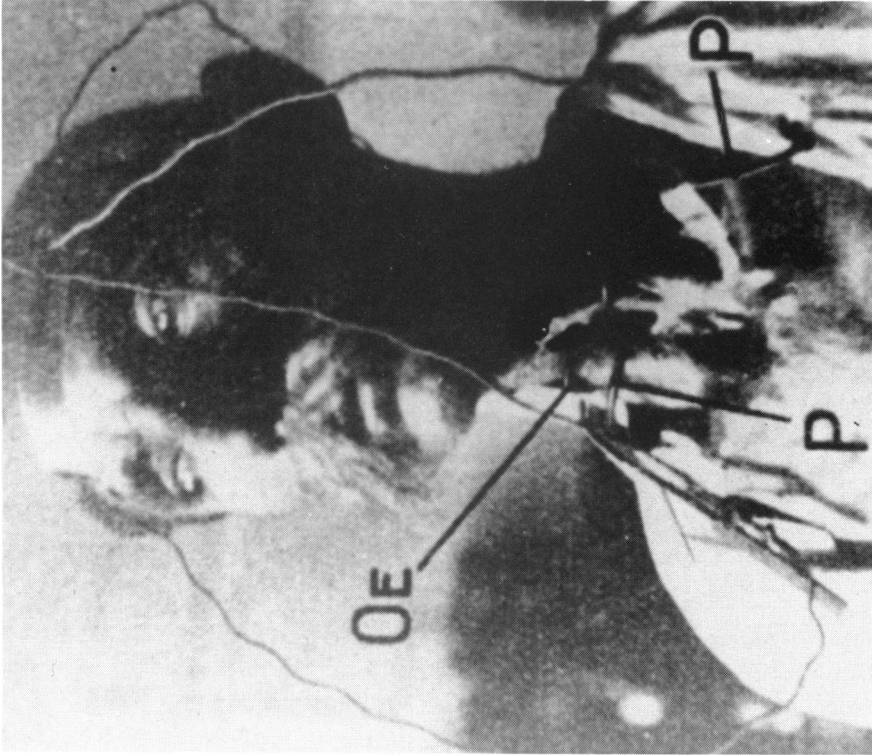


Plate 1. The early concern about electrode placement for the study of electric potentials prompted Savjaloff to suggest the interesting reference system shown (From Vsevolod V. Savjaloff, *Zt. Kreislauff.*, 1929, 21: 705-716.)

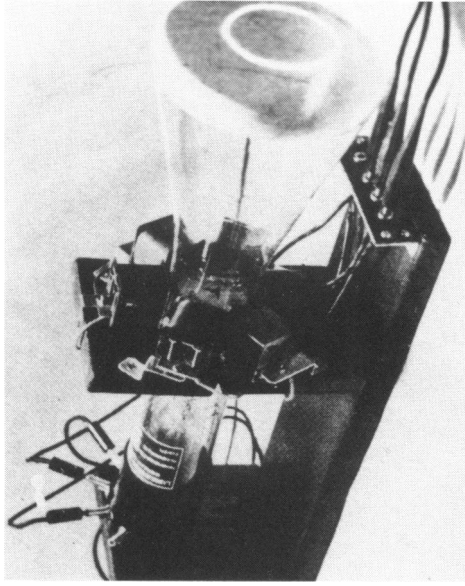


Plate 2. The cathode ray oscilloscope used by Hollmann and Hollmann in their vectorcardiograph, as reported in 1937. (From W. Hollmann and H.E. Hollmann, *Zt. Kreislauff.*, 1937, 29: 546-558).

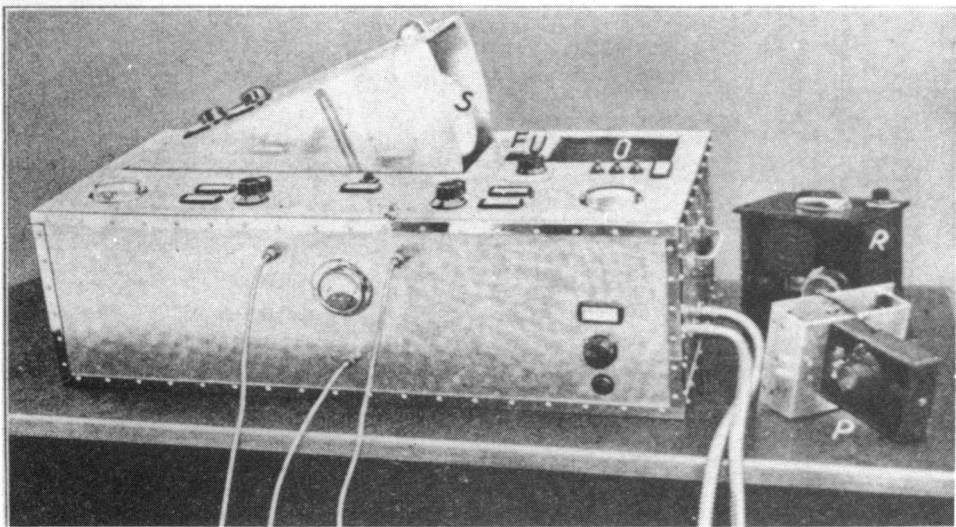
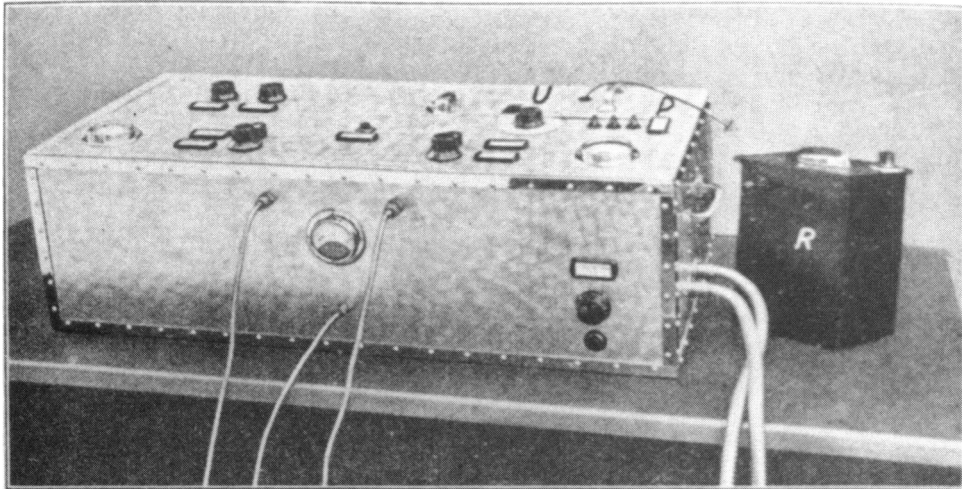


Plate 3. The Hollmann and Hollmann cathode ray oscilloscopic vectorcardiograph. (From W. Hollmann and H.E. Hollmann, *Zt. Kreislauff.*, 1937, 29: 546-558.)

The history of vectorcardiography

reproducible, and also made it possible to construct wire models accurately for detailed study. Approximately 5,000 such models were constructed during the course of our investigations. The equipment used, which was designed and constructed in our own laboratory, and an assortment of these wire loop models are preserved in the Smithsonian Institution in Washington, DC.

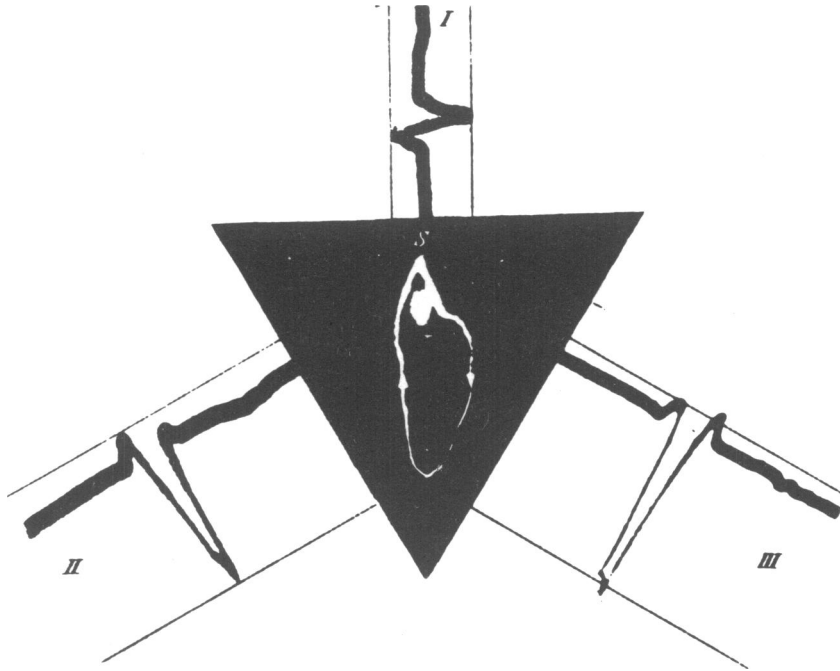


Figure 20. The directly recorded vectorcardiogram and standard limb leads reported by Hollmann and Hollmann in 1937, showing the relationships of these two types of tracings. (From W. Hollmann and H.E. Hollmann, *Zt. Kreislauff.*, 1937, 29: 546-558.)

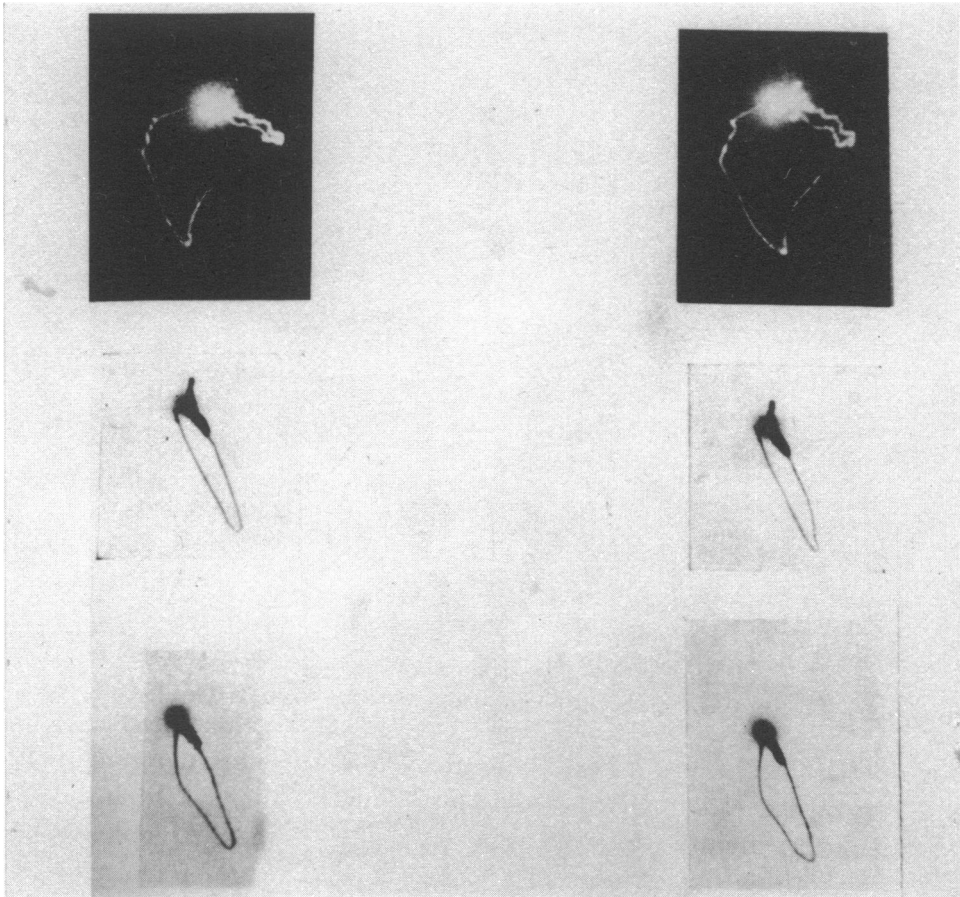


Figure 21. Stereovectorcardiograms recorded by Hollmann and Hollmann with their vectorcardiograph and published in 1938. (From H.E. Hollmann and W. Hollmann, *Zt. klin. Med.*, 1938, 134: 732-753.)

The history of vectorcardiography

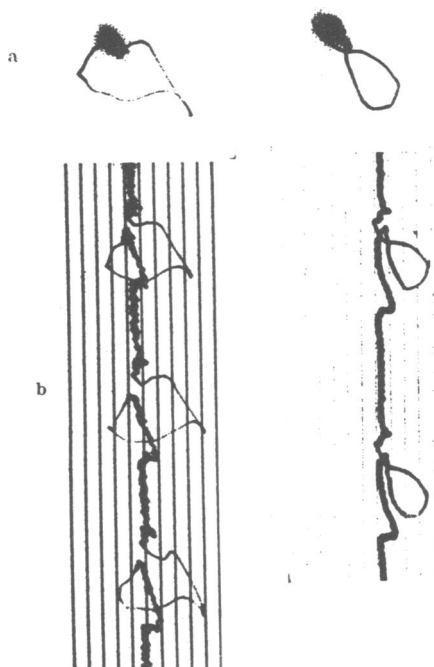


Figure 22. The “scroll” (continuous vectorcardiogram) as recorded first by Hollmann and Hollmann using the cathode ray oscilloscope. Mann had also recorded the “scroll” by 1938 using his mirror-type vectorcardiograph. (From H.E. Hollmann and W. Hollmann, *Zt. klin. Med.*, 1938, **134**: 732-753.)

CLINICAL APPLICATION OF VECTORCARDIOGRAPHY

The immediate concern, as would be expected, was the possible clinical usefulness, if any, of the vectorcardiogram. The theoretic aspects of the vectorcardiographic trace were well understood by the experts who were developing the vectorcardiographic techniques. Mann became interested in the clinical usefulness of the vectorcardiogram (“monocardiogram”) even prior to 1931¹¹ and, employing his mirror recorder, reported monocardiograms of various cardiac disorders in 1938.⁸ However, the superiority of the cathode ray oscilloscope quickly displaced Mann’s mirror galvanometer. Nevertheless, his monocardiograph was an important historical development during the early days of vectorcardiographic research.

Schellong’s report of 1936¹² included a study of abnormal electrocardiograms and cardiac disease states in which he correlated the vectorcardiographic trace and patterns with the electrocardiogram and associated cardiac abnormalities (fig. 23).

Wilson and his associates were also concerned about the clinical applications of vectorcardiography. They reported in 1938 their studies of the correlations of the electrocardiogram and vectorcardiogram.¹⁹ Whereas Mann had named the record the “monocardiogram”, Wilson and Johnston suggested the term “vectorcardiogram” in 1938. This term has been accepted generally. Thus, by 1938 interest in vectorcardiography had developed in several centres of the world. Those investigators who could afford the automatic electronic cathode ray oscilloscopic

recorders began to install them, whereas those who did not have such equipment still used the manual construction technique, such as reported by Routier²³ (fig. 24).

Rudolph Burger and F. Wuhrmann, in 1939, reported studies on the vectorcardiogram in which they used manual construction methods to derive the trace from the three standard limb leads.²⁴ They referred to their trace as the vectordiogram (VD), which it was. This report was also concerned with surface mapping of isopotential lines of mean cardiac dipole and precordial and other surface recording of electrocardiographic leads from the surface of the chest and upper abdomen. There was considerable interest in determining the additional useful, practical, clinical, or theoretical information that might be obtained from this new field of study, vectorcardiography. Rochet and Vastesaeger, using the oscilloscope in Brussels, reported studies of the normal variations in cardiac vectors.^{25,26} They, too, were concerned about the clinical usefulness of vectorcardiography, which still remained unknown.²⁷

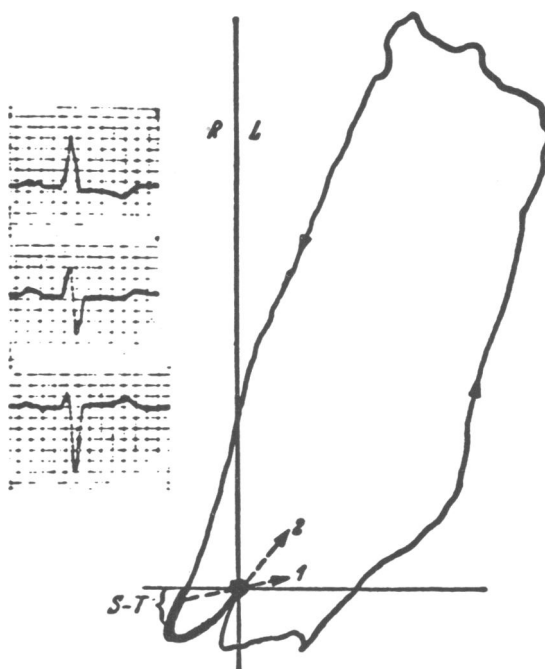


Figure 23. The vectorcardiogram of a patient with left ventricular hypertrophy reported by Schellong in 1936. (From F. Schellong, *Verhandl. Dt. Gesell. inn. Med.*, 1936, 48: 288-310.)

²³ Daniel Routier, 'Le vectogramme' *Arch. mal. Coeur Vais.*, 1938, 31: 697-704.

²⁴ R. Burger and F. Wuhrmann, 'Ueber das elektrische Feld des Herzens', *Cardiologia*, 1939, 3: 139-168.

²⁵ Jean Rochet and Marcel-M. Vastesaeger, 'La variation de la valeur manifeste et de l'angle α pendant le cycle cardiaque normal chez l'homme', *Arch. internat. Physiol.*, 1939, 49: 113-126.

²⁶ J. Rochet and M.-M. Vastesaeger, 'La vectocardiogramme de l'homme normal', *Trav. Lab. Inst. Solvay Physiol.*, 1944, 29: 17.

²⁷ M.M. Vastesaeger and J. Rochet, 'La stéréovectocardiographie et la stéréovectocardioscopie: méthodes cliniques d'étude de la répartition spatiale des potentiels cardiaques', *ibid.*, 1944, 29: 40.

The history of vectorcardiography

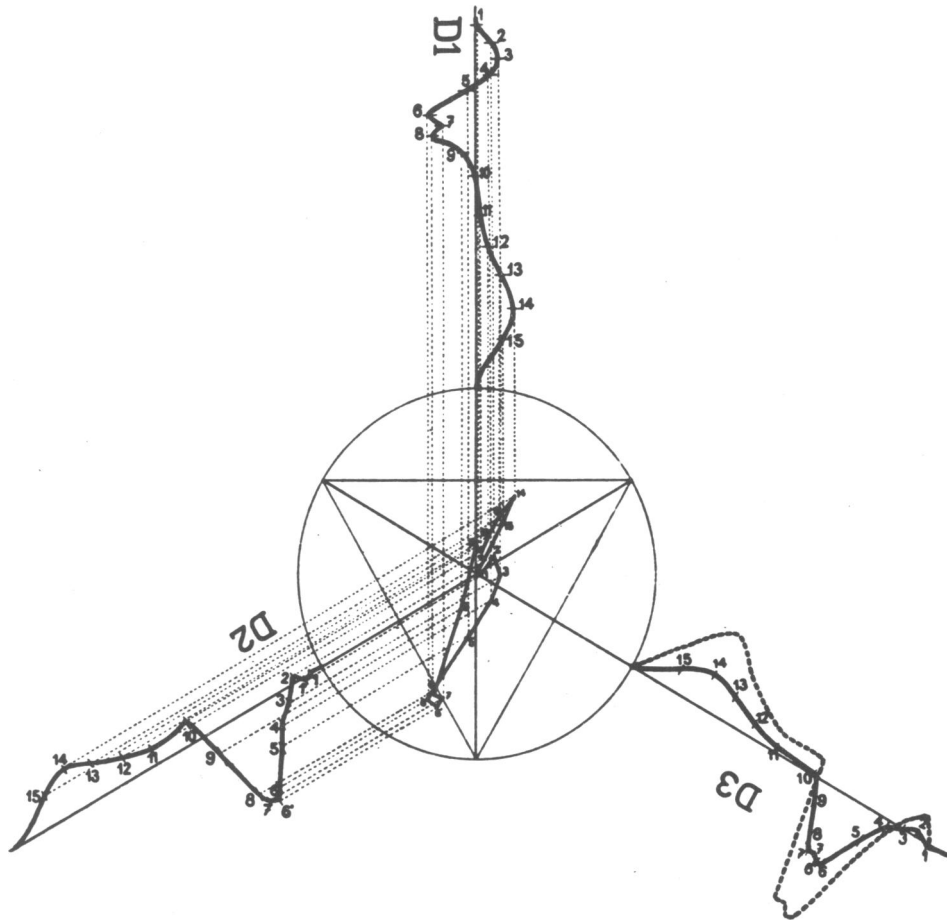


Figure 24. A detailed manual construction of the vectorcardiogram from the standard limb leads reported in 1938 by Routier. (From Daniel Routier, *Arch. mal. Coeur Vais.*, 1938, 31: 697-704.)

In 1939, in a classic and extensive paper,²⁸ Schellong again described the vectorcardiograms associated with many abnormal cardiac states and electrocardiographic disorders using his reference frame of electrode placement.

REFERENCE SYSTEMS IN VECTORCARDIOGRAPHY

By the late 1930s and early 1940s, there was considerable concern and argument about the best reference system that should be used to record the vectorcardiogram (VCG) and spatial vectorcardiogram (sVCG). Arrighi, in 1939, for example, suggested a new and quite different electrode site (fig. 25) to obtain a sagittal view of the electric potential associated with the heartbeat.²⁹ This reference system, though

²⁸ F. Schellong, 'Grundzüge einer klinischen Vektordiagraphie des Herzens', *Ergebn. inn. Med. Kinderheilk.*, 1939, 56: j1657-743.

²⁹ Federico P. Arrighi, 'El eje eléctrico del corazón en el espacio con el estudio, y empleo de las derivaciones sagitales. Eje eléctrico y electrocardiogramma en el plano sagital', *La Prensa Med. Argent.*, 1939, 26: 253-282.

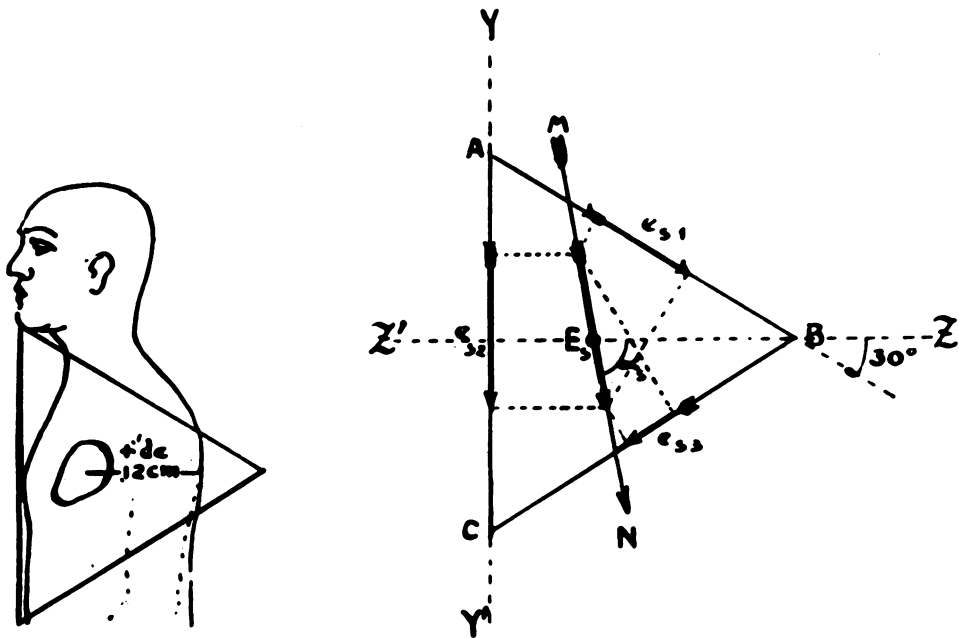


Figure 25. The Arrighi triangle described in 1939 for vector analysis. (From Federico P. Arrighi, *La Prensa Med. Argent.*, 1939, 26: 253-282.)

interesting and reflecting the existing concern about reference systems of electrode placement, was not accepted generally.

Sulzer and Duchosal, who had become intensely interested in vectorcardiography, employed the “double cube” (rectangular) reference frame for their studies, which they reported in 1942.³⁰ They strongly indicated its advantages while studying the vectorcardiogram and spatial vectorcardiogram in heart disease and its advantages from the theoretic point of view. These investigators^{5,31} of Switzerland, like many others, were concerned about the “correct” electrode placement, i.e. what recording technique would display the “true” or “correct” situation for the electric forces within the heart. This idea of errors and correctness engaged and commanded the attention of quite a number of investigators. It was evident that the surface potentials recorded at the surface of the body were correct within themselves and “correct” for the method used. No method could accurately display the precise time course of potentials within the heart.

This was only one of the topics being debated in medical literature and at medical meetings throughout the world and which resulted in the clarification of vectorcardiography. Bayley in 1943 and later, using the concept of the ventricular gradient and the vectorcardiogram, emphasized the theoretical concepts of

³⁰ R. Sulzer and P.W. Duchosal, ‘Principes de cardioectographie. I. La planographie’, *Cardiologia*, 1942, 6: 236-250.

³¹ R. Sulzer and P.W. Duchosal, ‘Principes de cardioectographie. II. La stéréographie’, *ibid.*, 1945, 9: 106-120.

The history of vectorcardiography

electrocardiography and vectorcardiography.³² He introduced some of the new symbols now used in spatial vectorcardiography, such as QRS sÊ-loop, T sÊ-loop, etc. The electrocardiographic letters (QRS,T,etc.) indicate the comparable complex in the electrocardiogram; “s” indicates that the vectorcardiogram is spatial; the “caret” (ˆ) placed over the E indicates that it is a vector quantity; “E” indicates it is electric potential; and “loop” indicates that it is a vectorcardiogram. This type of symbol was of great assistance in writing and speaking on the subject.

Between 1946 and 1948, H.C. Burger and van Milaan reported studies of heart vector leads,^{33,34,35} which resulted in important contributions to electrocardiography concerning reference frames and standardizing or correction factors, a great deal of which is applicable to vectorcardiography as well.

As mentioned above, the concern over the “most accurate” reference frame of electrode placement for vectorcardiography demanded and received considerable attention and probably wasted a considerable amount of time and effort. Schellong introduced his system and made important contributions to vectorcardiography through the use of that system. Duchosal and Sulzer introduced the “double cube” (rectangular) reference frame as a system of electrode placement, whereas Grishman and associates³⁶ advocated the cube. The cubic system was employed extensively at first but it rapidly became little used and now is apparently not used at all. Schmitt³⁷ also became interested in lead placement and described several types of electrode placement for vectorcardiography. Wilson, Johnston, and Kossmann introduced the equilateral tetrahedron as a reference frame for spatial vectorcardiography in 1947.³⁸ This system required the placement of only one electrode in addition to those already used in electrocardiography for recording the three standard limb leads. This fourth position is easy to locate, is reproducible and establishes for analytical purposes a volume frame of reference which consists of four surfaces, each an equilateral triangle of Einthoven, so that any theoretical and clinical principles already developed for the equilateral triangle for the frontal plane could be applied to the four surfaces of the equilateral tetrahedron. We introduced various “correction factors” into the electric network to provide the necessary “theoretical” configurations desired to “establish” an equilateral triangle frame of reference.³⁹ We were among the first to investigate vectorcardiography. The investigations by us included standardization of reference frames, establishment of correction factors for

³²Robert H. Bayley, ‘On certain applications of modern electrocardiographic theory to the interpretation of electrocardiograms which indicate myocardial disease’, *Am. Heart J.*, 1943, **26**: 769-831.

³³H.C. Burger and J.B. van Milaan, ‘Heart-vector and leads’, *Br. Heart J.*, 1946, **8**: 157-161.

³⁴H.C. Burger and J.B. van Milaan, ‘Heart-vector and leads’, Part II, *ibid.*, 1947, **9**: 154-160.

³⁵H.C. Burger and J.B. van Milaan, ‘Heart-vector and leads. Part III: Geometrical representation’, *ibid.*, 1948, **10**: 229-233.

³⁶Arthur Grishman, E. Raymond Borun, and Harry L. Jaffe, ‘Spatial vectorcardiography: technique for the simultaneous recording of the frontal, sagittal, and horizontal projections. I.’, *Am. Heart J.*, 1951, **41**: 483-493.

³⁷Otto H. Schmitt, ‘Cathode-ray presentation of three-dimensional data’, *J. appl. Physics*, 1947, **18**: 819-829.

³⁸F. N. Wilson, F.D. Johnston, and Charles E. Kossmann, ‘The substitution of a tetrahedron for the Einthoven triangle’, *Am. Heart J.*, 1947, **33**: 594-603.

³⁹George E. Burch, J.A. Abildskov. and James A. Cronvich, *Spatial vectorcardiography*, Philadelphia, Lea & Febiger, 1953, pp. 67-72.

lead placement, study of recording techniques and equipment, clinical correlations of the vectorcardiogram with heart disease, and applications of vectorcardiography in cardiology. It is my opinion that the equilateral tetrahedron offers reproducibility and accuracy in electrode placement for serial recordings and comparison of tracings. It is simple to use, reliable, and just as informative as any other reference frame that is carefully employed.^{40,41,42}

At present the Frank system is used in most areas of the world.^{43,44,45} Introduced in 1954, it is based upon one torso plastic model and theoretical mathematic considerations. The reasons for its acceptance are not very clear. The reproducibility of electrode placement from time to time is quite variable and poor and is impossible in routine recordings. The system is difficult to use correctly in all patients, it is time-consuming to apply, and it is especially difficult to apply the electrodes properly

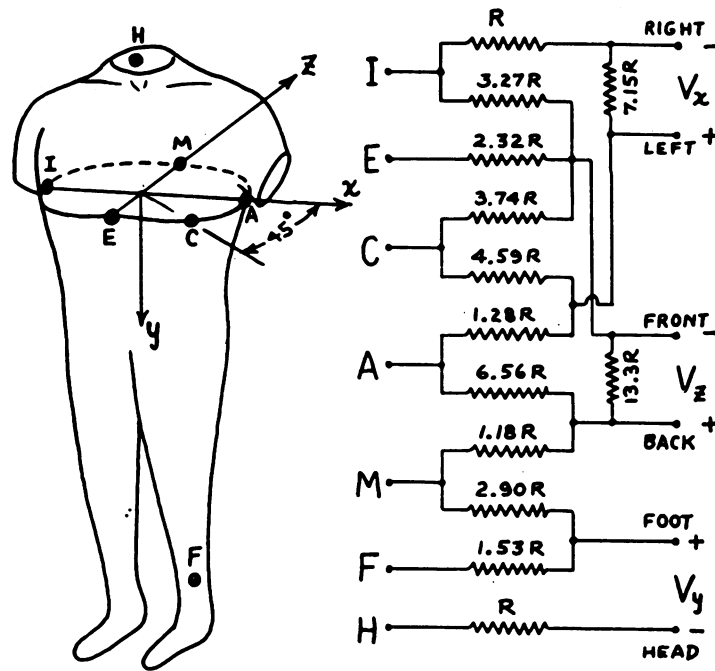


Figure 26. The electrode placement and circuitry for the Frank reference system for vectocardiography described in 1956. (From Ernest Frank, *Circulation*, 1956, 13: 737-749.)

⁴⁰ J.A. Abildskov, G.E. Burch, and J.A. Cronvich, 'The validity of the equilateral tetrahedron as a spatial reference frame', *Circulation*, 1950, 2: 122-125.

⁴¹ G.E. Burch, J.A. Cronvich, and Zang Z. Zao, 'Vectorcardiographic deflections obtained with various reference systems in cadavers', *Am. Heart J.*, 1961, 61: 667-669

⁴² G.E. Burch, N.P. DePasquale, and J.A. Cronvich, 'A standard reference system for spatial vectorcardiography. Comparison of the equilateral tetrahedron and the Frank systems', *ibid.*, 1970, 80: 638-659.

⁴³ Ernest Frank, 'The image surface of a homogeneous torso', *ibid.*, 1954, 47: 757-768.

⁴⁴ E. Frank, 'An accurate, clinically practical system for spatial vectorcardiography', *Circulation*, 1956, 13: 737-794.

⁴⁵ E. Frank and Calvin F. Kay, 'Frontal plane studies of homogeneous torso models', *ibid.*, 1954, 9: 724-740.

The history of vectorcardiography

on fat women with large breasts and almost impossible on newborn infants. Fig. 26 briefly indicates the Frank system of electrode placement.

Some of the suggested systems of electrode placement for vectorcardiography are summarized in fig. 27.⁴⁶ There were innumerable suggestions and modifications of systems. The isosceles tetrahedron was even suggested to replace the equilateral tetrahedron,³⁹ but the latter was considered simpler and more desirable.

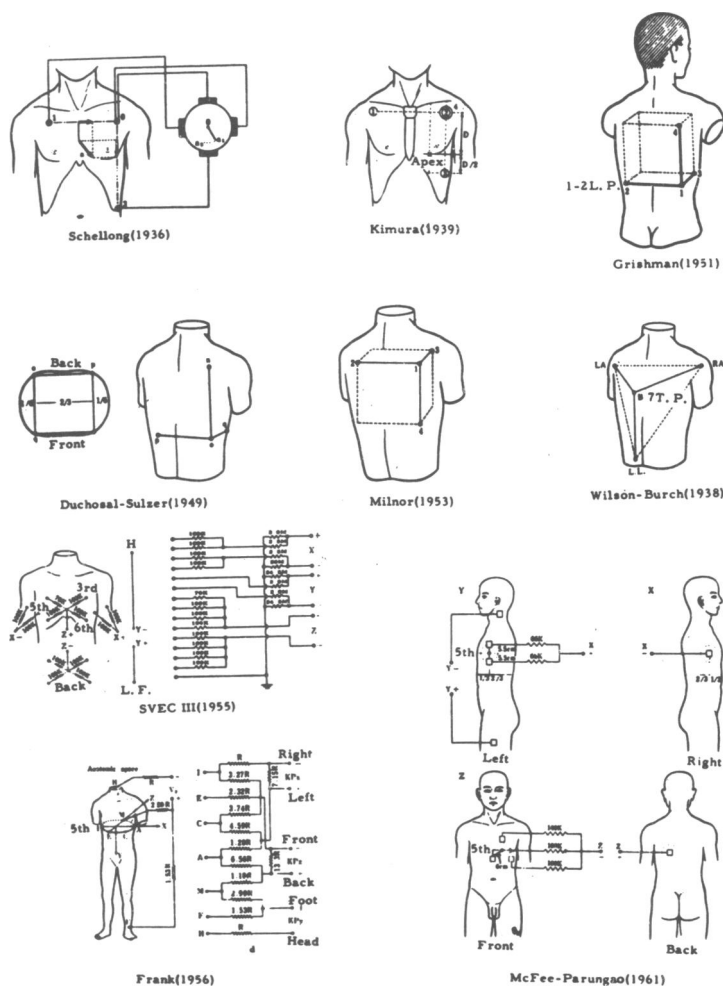


Figure 27. Illustration summarizing some of the reference frames suggested for vectorcardiography. (From Irwin Hoffman and Robert C. Taymor, *Vectorcardiography*, Amsterdam, North Holland Publishing Co., 1966, p. 4.)

⁴⁶ Irwin Hoffman and Robert C. Taymor (editors), *Vectorcardiography*, Amsterdam, North Holland Publishing Co., 1966.

Thus, the spatial vectorcardiogram has been subjected to various methods of study and analysis—those mentioned above as well as others.⁴⁷⁻⁶⁷ As noted above, by means of electrode placement or by photographic techniques, stereoscopic views of the vectorcardiograms were produced and studied and three-dimensional wire models of the vectorcardiograms were constructed for spatial viewing and orientation. These methods are still used by some investigators to study spatial vectorcardiograms.

GENERAL COMMENTS

During the past fifty years or so, the vectorcardiogram has been studied in patients with different types of heart disease and cardiac arrhythmias. Not only have the vectorcardiographic changes associated with different cardiac disease states been

⁴⁷ E. Donzelot and J.-B. Milovanovich, 'Introduction à la vectographie spatiale et à l'électrocardiographie vectorielle', *Arch. mal. Coeur. Vais.*, 1948, **41**: 586-601.

⁴⁸ Raphael B. Levine and Otto H. Schmitt, 'Three dimensional electrocardiography', *Fed. Proc.*, 1949, **8**: 95.

⁴⁹ John P. Conway, J.A. Cronvich, and G.E. Burch, 'Observations on the spatial vectorcardiogram in man', *Am. Heart J.*, 1949, **38**: 537-546.

⁵⁰ A. Jouve, P. Buisson, A. Albouy, P. Velasque, and G. Bergier, *La vectorcardiographie en clinique*, Paris, Masson, 1950.

⁵¹ John Shillingford and Wallace Brigden, 'The vectorcardiogram in 100 healthy subjects using a new drawing instrument', *Br. Heart J.*, 1951, **13**: 233-341.

⁵² Pierre W. Duchosal and Jean R. Groscurin, 'The spatial vectorcardiogram obtained by use of a trihedron and its scalar comparisons', *Circulation*, 1952, **5**: 237-248.

⁵³ Abraham I. Schaffer and William H. Beinfield, 'The vectorcardiogram of the newborn infant', *Am. Heart J.*, 1952, **44**: 89-94.

⁵⁴ O.H. Schmitt and R.B. Levine, 'Direct visual examination of stereovectorelectrocardiograms', *Fed. Proc.*, 1952, **11**: 140.

⁵⁵ O. H. Schmitt, Raphael B. Levine, and Ernst Simonson, 'Electrocardiographic mirror pattern studies, I. Experimental validity tests of the dipole hypothesis and of the central terminal theory', *Am. Heart J.*, 1953, **45**: 416-428.

⁵⁶ E. Frank, 'Theoretic analysis of the influence of heart-dipole eccentricity on limb leads, Wilson central-terminal voltage and the frontal-plane vectorcardiogram', *Circ. Res.*, 1953 **1**: 380-388.

⁵⁷ H.K. Hellerstein, Denman Shaw, and Toyamo Sano, 'Dissection of the vectorcardiogram (differential vectorcardiography)', *J. lab. clin. Med.* 1953, **42**: 814-815.

⁵⁸ G.E. Burch, J.A. Abildskov, and J.A. Cronvich, 'Studies of the spatial vectorcardiogram in normal man', *Circulation*, 1953, **7**: 558-572.

⁵⁹ J.A. Cronvich, G.E. Burch, and J.A. Abildskov, 'Some requirements in equipment and technics for vectorcardiography', *ibid.*, 1953, **8**: 914-919.

⁶⁰ G.E. Burch, J.A. Abildskov, and J.A. Cronvich, 'A study of the spatial vectorcardiogram of the ventricular gradient', *ibid.*, 1954, **9**: 267-275.

⁶¹ Noble O. Fowler and Edward R. Dorney, 'Studies of the P loop of the spatial vectorcardiogram: the normal P loop', *Am. Heart J.*, 1954, **48**: 36-41.

⁶² Ernst Simonson, O.H. Schmitt, James Dahl, Donald Fry, and Earl E. Bakken, 'The theoretical and experimental bases of the frontal plane ventricular gradient and its spatial counterpart', *ibid.*, 1954, **47**: 122-153

⁶³ J.A. Abildskov, J.A. Cronvich, and G.E. Burch, 'An analysis of activation in human atria', *Circulation*, 1955, **11**: 97-105.

⁶⁴ L.G. Horan, G.E. Burch, and J.A. Cronvich, 'A study of the influence upon the spatial vectorcardiogram of localized destruction of the myocardium of dog', *Am. Heart J.*, 1957, **53**: 74-90.

⁶⁵ Irving L. Rosen and Manuel Gardberg, 'The electrocardiogram and vectorcardiogram of the normal infant', *Dis. Chest.*, 1957, **32**: 493-519.

⁶⁶ Richard McFee, 'An orthogonal lead system for clinical electrocardiography', *Am. Heart J.*, 1961, **62**: 93-100.

⁶⁷ Waldemar J. Wajszczuk and G.E. Burch, 'Analysis of the Ts \bar{E} loop in normal subjects of different ages', *Am. J. Cardiol.*, 1962, **10**: 507-513.

The history of vectorcardiography

elucidated, but normal variations in the tracings have been learned. A great deal of attention was devoted to these problems once the cathode ray oscilloscope made it relatively easy to record accurately the vectorcardiogram.

We have worked extensively with vectorcardiography to learn its clinical usefulness. We studied numerous sVCGs from normal subjects and showed them to be of two basic types,^{39,58} one of which represents essentially eighty per cent of recordings from normal people and the other about twenty per cent. We examined many hearts at autopsy and correlated the post-mortem findings with both the electrocardiographic and spatial vectorcardiographic recordings. We described various sVCG patterns,⁶⁸⁻⁷⁹ including those for diffuse myocardial damage and ventricular aneurysm, high basal infarction, ageing, localized myocardial hypertrophy, left and right bundle branch blocks, and other abnormalities. We demonstrated that the spatial vectorcardiogram can provide clinically useful information. We showed, for example, that lesions involving the high basal and lateral aspects of the heart which are depolarized last could be detected by the distortion produced by these lesions in the terminal portion of the sE-loop of the QRS complex and the terminal portion of the QRS complex of the conventional electrocardiogram. This revealed the fact that all patients who have infarction do not necessarily have Q wave abnormalities. Also, we showed that the sVCG can pathognomically distinguish between the secundum and primum types of atrial septal defect, the QRS loops being so characteristically distinctive that even untrained persons could readily detect the difference.

It is beyond the scope of this brief review of the history of vectorcardiography to review and summarize the many published reports, including our own, or even to

⁶⁸ J. Frank Pantridge, J.A. Abildskov, G.E. Burch, and J.A. Cronvich, 'A study of the spatial vectorcardiogram in left bundle branch block', *Circulation*, 1950, **1**: 893-901.

⁶⁹ J.A. Abildskov, C.E. Jackson, G.E. Burch, and J.A. Cronvich, 'The spatial vectorcardiogram in right bundle branch block', *ibid.*, 1951, **3**: 600-605.

⁷⁰ Leo G. Horan, G.E. Burch, J.A. Abildskov, and J.A. Cronvich, 'The spatial vectorcardiogram in left ventricular hypertrophy', *ibid.*, 1954, **10**: 728-734.

⁷¹ G.E. Burch, Lawrence H. Golden, and J.A. Cronvich, 'An analysis of changes in the spatial vectorcardiogram with aging', *Am. Heart J.*, 1958, **55**: 582-590.

⁷² G.E. Burch, L.G. Horan, Joseph Ziskind, and J.A. Cronvich, 'A correlative study of postmortem, electrocardiographic, and spatial vectorcardiographic data in myocardial infarction', *Circulation*, 1958, **18**: 325-340.

⁷³ G.E. Burch, L.G. Horan, and J. A. Cronvich, 'An electrocardiographic and spatial vectorcardiographic pattern associated with diffuse myocardial damage and ventricular aneurysm', *Am. Heart J.*, 1959, **57**: 762-768.

⁷⁴ G.E. Burch and Nicholas P. DePasquale, 'The spatial vectorcardiogram in proved congenital atrial septal defect', *ibid.*, 1959, **58**: 319-326.

⁷⁵ George E. Burch and N.P. DePasquale, 'Electrocardiographic and vectorcardiographic detection of heart disease in the presence of the pre-excitation syndrome (Wolff-Parkinson-White Syndrome)'. *Ann. intern. Med.*, 1961, **54**: 387-404.

⁷⁶ G.E. Burch and N.P. DePasquale, 'The spatial vectorcardiogram and ventricular gradient in left bundle branch block with autopsy studies', *So. med. J.*, 1961, **54**: 1223-1241.

⁷⁷ G.E. Burch and N.P. DePasquale, 'Electrocardiogram and spatial vectorcardiogram of localized myocardial hypertrophy', *Circulation*, 1962, **26**: 544-552.

⁷⁸ N.P. DePasquale and G.E. Burch, 'The electrocardiogram, ventricular gradient and spatial vectorcardiogram during the first week of life', *Am. J. Cardiol.*, 1963, **12**: 482-493.

⁷⁹ G.E. Burch and N.P. DePasquale, *Electrocardiography in the diagnosis of congenital heart disease*, Philadelphia, Lea & Febiger, 1967.

attempt to describe the vectorcardiograms in all disturbances in cardiac rhythm, electric activation, and cardiac disease. The vectorcardiogram in normal people and in ischaemic heart disease, myocardial infarction, ventricular hypertrophy, and right and left bundle branch block, Wolff-Parkinson-White syndrome, congenital heart disease, and many other cardiac states have been described throughout the years subsequent to 1931. Unfortunately, rarely has the vectorcardiogram actually shown some aspect of the electric potential from the heart that was not already clearly evident from the electrocardiogram. This has been one reason for its slow development in clinical cardiology.

There remains a need to establish a simple, reproducible and useful system of electrode placement as a universal reference system to compare studies, as can be done in electrocardiography. A standard method would make comparison possible. No reference system can be perfect. The relationship of vectorcardiographic patterns to various types of heart disease can be determined only by clinical correlation, and especially with careful clinicopathological studies. Routine autopsy data are too unreliable for satisfactory use in studies of this type. The hearts are too often not examined thoroughly, either grossly or microscopically, at routine autopsy.

The lack of simple, reliable equipment for recording the spatial vectorcardiogram has been an important factor responsible for the failure of vectorcardiography to be used extensively or more generally in clinical studies of patients. The electronic equipment, photography, mounting of recordings, etc., were among the many complex, time-consuming, expensive and difficult aspects of vectorcardiography. However, recently a good direct-writing vectorcardiograph has been introduced that can be used in the clinic, office, and hospital. A company (Instruments for Cardiac Research, Inc.) in Syracuse, New York, has marketed a vectorcardiograph which has high fidelity and is a direct-writing pen recorder (X-Y recorder). The recording is stored in a memory computer circuit with a good and high frequency response and is played back slowly into an ink-writing X-Y recorder. The rate of activation of the X-Y recorder from the memory component of the vectorcardiograph is well below the rate of response of the direct-writer. This new recorder, though expensive, has simplified vectorcardiographic recording in the clinic, office, and hospital.

It is my opinion that the equilateral tetrahedron reference frame should become the standard method of electrode placement because of its practicability, simplicity, reliability, and reproducibility. With good equipment and a method simple to use and standard throughout the world, the value of vectorcardiography in clinical medicine could be investigated and its role in clinical and experimental medicine determined.

Regardless of its questionable value in clinical practice, vectorcardiography proved to be valuable in research and education. To express the cardiac electric potentials in vector quantities is an excellent idea. But, before the vectorcardiogram can become an indispensable procedure in clinical practice, its correlation with heart disease is absolutely necessary, just as such correlation was necessary for electrocardiograms.

Finally, it would be negligent to fail to indicate some of the shortcomings of vectorcardiography as revealed thus far. Its greatest shortcoming is its inability to record heartbeats continuously. It is a technique for studying a single cardiac cycle

The history of vectorcardiography

selected at random. The vectorcardiogram is not satisfactory for measuring time intervals, as is the electrocardiogram. Other electrophysical shortcomings of vectorcardiography apply equally as well to the conventional twelve-lead electrocardiogram. The volume conductors around the heart are not homogeneous, the electrodes cannot be placed remote from the heart, and the heart varies in position from time to time, within a cardiac cycle, with disease and among people. But electrocardiography has proved to be extremely valuable in spite of such shortcomings. This may eventually be true for vectorcardiography. There is a great need to record and study vectorcardiograms in all laboratories with standard methods and standard equipment to establish its true value.