

Edinburgh Mathematical Society.

LIST OF MEMBERS.

TWENTY-FIRST SESSION 1902-1903.

- 1 V. RAMASWAMI AIYAR, M.A., Prob. Dy. Collector, Trichinopoly, India.
ROBERT J. ALEY, Professor of Mathematics, Indiana University, Bloomington, Indiana, U.S.A.
J. ALISON, M.A., F.R.S.E., U.F.C. Training College, Glasgow.
R. E. ALLARDICE, M.A., Professor of Mathematics, Leland-Stanford Junior University, Palo Alto, California.
- 5 ERNEST M. ANDERSON, M.A., B.Sc., 65 Warrender Park Road, Edinburgh.
WM. ANDERSON, M.A., George Watson's College, Edinburgh.
JAMES ARCHIBALD, M.A., 52 Polwarth Gardens, Edinburgh (*Honorary Treasurer*).
PAUL AUBERT, Professeur au Lycée Charlemagne, Paris.
A. J. GUNION BARCLAY, M.A., F.R.S.E., High School, Glasgow.
- 10 E. P. BARRETT, B.A., Foyle College, Londonderry.
J. C. BEATTIE, D.Sc., F.R.S.E., Professor of Applied Mathematics and Experimental Physics, South African College, Cape Town.
ROBT. J. T. BELL, M.A., B.Sc., 90 Barrington Drive, Glasgow.
PETER BENNETT, Glasgow and West of Scotland Technical College, Glasgow.
JAMES BOLAM, Leith Nautical College, Leith.
- 15 Professor T. J. P'A BROMWICH, M.A., Queen's College, Galway.
A. BROWN, M.A., B.Sc., Gonville and Caius College, Cambridge.
H. H. BROWNING, M.A., B.D., 128 Byres' Road, Glasgow.
J. BRUCE-KINGSMILL, R.A., The Ordnance College, Woolwich.

- JAMES BUCHANAN, M.A., 9 St Andrew Square, Edinburgh.
- 20 A. G. BURGESS, M.A., F.R.S.E., Ladies' College, Queen Street, Edinburgh.
- J. W. BUTTERS, M.A., B.Sc., F.R.S.E., Rector, The Academy, Ardrossan.
- JOHN F. CAMERON, M.A., Fellow and Tutor of Caius College, Cambridge.
- GEORGE A. CARSE, M.A., B.Sc., Physical Laboratory, University of Edinburgh.
- HORATIO S. CARSLAW, M.A., D.Sc., F.R.S.E., University, Sydney, Australia.
- 25 CHARLES CHREE, M.A., D.Sc., F.R.S., 25 Mount Ararat Road, Richmond, Surrey.
- GEORGE CHRYSTAL, M.A., LL.D., Sec.R.S.E., Professor of Mathematics, University, Edinburgh (*Hon. Member*).
- J. B. CLARK, M.A., F.R.S.E., George Heriot's School, Edinburgh.
- G. E. CRAWFORD, M.A., Wykeham House, Manilla Road, Clifton, Bristol.
- LAWRENCE CRAWFORD, M.A., D.Sc., Professor of Mathematics, South African College, Cape Town.
- 30 R. F. DAVIS, M.A., 12 Rusthall Avenue, Acton Green, London, W.
- J. D. HAMILTON DICKSON, M.A., F.R.S.E., Peterhouse, Cambridge.
- J. MACALISTER DODDS, M.A., Peterhouse, Cambridge.
- CHAS. S. DOUGALL, M.A., Rector, The Institution, Dollar.
- JOHN DOUGALL, M.A., Kippen, Stirlingshire.
- 35 ALBERT DRIVER, M.A., George Watson's College, Edinburgh.
- DAVID DRYSDALE, M.A., George Heriot's School, Edinburgh.
- GEORGE DUTHIE, M.A., B.A., F.R.S.E., Director-General of Education, Salisbury, Rhodesia.
- JAMSHEDJI EDALJI, Professor, Gujarat College, Ahmedabad, India.
- GEORGE EDNIE, M.A., B.Sc., The Academy, Dumfries.
- 40 JAS. M. EDWARD, M.A., Headmaster, Wigtown.
- JOHN EDWARDS, M.A., The Academy, Ardrossan.
- R. M. FERGUSON, Ph.D., LL.D., F.R.S.E., 5 Douglas Gardens, Edinburgh.
- JAMES FINDLAY, 11 Morningside Gardens, Edinburgh.
- MARGARET FORREST, 1 Magdala Crescent, Edinburgh.
- 45 Rev. NORMAN FRASER, B.D., 84 Craiglea Drive, Edinburgh.
- H. T. GERRANS, M.A., Fellow and Tutor of Worcester College, Oxford.

- G. A. GIBSON, M.A., F.R.S.E., Professor of Mathematics, West of Scotland Technical College, Glasgow (*Hon. Member*).
- JAMES GOODWILLIE, M.A., B.Sc., King's College, Aberdeen.
- W. J. GREENSTREET, M.A., Headmaster, Marling School, Stroud.
- 50 P. S. HARDIE, M.A., B.Sc., Hutcheson's Girls' Grammar School, Glasgow.
- R. P. HARDIE, M.A., Assistant to the Professor of Logic, University, Edinburgh.
- E. W. HERBERT, M.A., The Academy, Edinburgh.
- ALEX. HOLM, M.A., Girls' High School, Glasgow.
- JAMES HORNE, M.A., George Watson's College, Edinburgh.
- 55 JOHN JACK, M.A., Professor of Mathematics, Wilson College, Bombay.
- W. JACK, M.A., LL.D., Professor of Mathematics, University, Glasgow (*Hon. Member*).
- Rev. FRANK H. JACKSON, M.A., R.N., Chaplain and Naval Instructor, H.M.S. "Irresistible," Malta.
- GEORGE JOHNSTON, M.A., Spier's School, Beith.
- D. M. JOHNSTONE, M.A., B.Sc., George Heriot's School, Edinburgh.
- 60 LORD KELVIN, LL.D., D.C.L., F.R.S., F.R.S.E., etc., Glasgow (*Hon. Member*).
- JOHN W. KIPPEN, Blackness Public School, Dundee.
- CARGILL G. KNOTT, D.Sc., F.R.S.E., Lecturer on Applied Mathematics, University, Edinburgh.
- P. R. SCOTT LANG, M.A., B.Sc., F.R.S.E., Professor of Mathematics, University, St Andrews.
- W. S. LAURIE, M.A., Mathematical Master, High School, Kelso.
- 65 GEORGE LAWSON, M.A., Rector, High School, Selkirk.
- R. LEES, M.A., B.Sc., Headmaster, The Academy, Fraserburgh.
- WM. A. LINDSAY, M.A., B.Sc., U.F. Church Training College, Cowcaddens, Glasgow (*Co-Editor of Proceedings*).
- ALEX. V. LOTHIAN, M.A., B.Sc., F.R.S.E., Mathematical and Science Lecturer, E.C. Training College, Glasgow.
- J. BARRIE LOW, M.A., Wrenschtown House, Observatory Road, Cape Town.
- 70 E. O. LOVETT, Professor of Mathematics, Princeton University, New Jersey, U.S.A.
- JOHN H. M'ALPINE, Viewfield, Kilmalcolm.
- JAS. M'CUBBIN, B.A., F.R.S.E., Rector, The Academy, Kilsyth.
- W. M'CUTCHEON, B.Sc., The Academy, Dumfries.

- JAS. A. MACDONALD, M.A., B.Sc., F.R.S.E., H.M.I.S., 3 Doune Terrace, Kelvinside, Glasgow.
- 75 J. A. MACDONALD, M.A., B.Sc., George Watson's Ladies' College, Edinburgh.
- W. J. MACDONALD, M.A., F.R.S.E., Daniel Stewart's College, The Dean, Edinburgh.
- D. C. M'INTOSH, M.A., F.R.S.E., Ladies' College, Queen Street, Edinburgh (*Hon. Secretary*).
- REV. JOHN MACK, B.D., The Manse, Inch, Aberdeenshire.
- ALEX. C. MACKAY, M.A., B.Sc., Rector, High School, Falkirk.
- 80 J. S. MACKAY, M.A., LL.D., F.R.S.E., The Academy, Edinburgh (*Hon. Member*).
- REV. JOHN MACKENZIE, M.A., Professor, U.F.C. College, Madras.
- P. MACKINLAY, M.A., Leamington Terrace, Edinburgh.
- ANGUS M'LEAN, B.Sc., C.E., Principal, Technical College, Paisley.
- DONALD MACMILLAN, M.A., Clifton Bank School, St Andrews.
- 85 J. CHRYSAL MACMILLAN, M.A., B.Sc., Corstorphine Hill House, Edinburgh.
- A. J. MARTIN, M.A., B.Sc., Spier's School, Beith.
- ARTEMAS MARTIN, M.A., Ph.D., LL.D., U.S. Coast Survey Office, Washington, D.C., U.S.A.
- J. B. MEIKLEJOHN, M.A., High School, Dundee.
- JOAQUIN DE MENDIZÁBAL Y TAMBORREL, Professeur de Mathématique, Palma, 13, Mexico.
- 90 W. J. MILLAR, C.E., late Secretary, Instit. Engineers and Ship-builders in Scotland, 31 Marine Place, Rothesay.
- JOHN MILLER, M.A., West of Scotland Technical College, Glasgow.
- T. HUGH MILLER, M.A., Training College, Isleworth, near London.
- ARCHIBALD MILNE, M.A., B.Sc., 5 Elgin Terrace, Edinburgh.
- HUGH MITCHELL, High Losset Farm, Machrihanish.
- 95 JAMES MITCHELL, M.A., B.Sc., 7 Bath Street, Nairn.
- GEORGE L. MOFFAT, M.A., B.Sc., The Academy, Glasgow.
- ALEXANDER MORGAN, M.A., D.Sc., F.R.S.E., Rector, Church of Scotland Training College, Edinburgh.
- J. T. MORRISON, M.A., B.Sc., F.R.S.E., Professor of Physics, Stellenbosch, Cape Colony.
- THOMAS MUIR, M.A., LL.D., F.R.S., F.R.S.E., C.M.G., Superintendent-General of Education, Mowbray Hall, Rosebank, Cape Colony.

- 100 R. FRANKLAND MUIRHEAD, M.A., B.Sc., 24 Kersland Street, Hillhead, Glasgow.
 ASUTOSH MUKHOPADHYĀY, M.A., LL.D., F.R.A.S., F.R.S.E., Professor of Mathematics, Bhowanipore, Calcutta.
 CHARLES NIVEN, M.A., D.Sc., F.R.S., Professor of Natural Philosophy, University, Aberdeen (*Hon. Member*).
 THOMAS NISBET, M.A., 4 Nisbet Street, Parkhead, Glasgow.
 R. T. OMOND, F.R.S.E., 3 Church Hill, Edinburgh.
- 105 L. F. OTTO, M.A., 12 Canning Road, Allahabad, India.
 JOHN T. PEARCE, B.A., Science College, Leith.
 FRANK PEARSON, M.A., George Watson's College, Edinburgh.
 WILLIAM PEDDIE, D.Sc., F.R.S.E., Lecturer on Natural Philosophy, University, Edinburgh.
 WM. EDWARD PHILIP, M.A., 13 Kersland Terrace, Hillhead, Glasgow.
- 110 ROBERT PHILP, M.A., Hutcheson's Grammar School, Glasgow.
 D. K. PICKEN, M.A., Lecturer, and Assistant Professor, University, Glasgow.
 PETER PINKERTON, M.A., George Watson's College, Edinburgh.
 R. H. PINKERTON, M.A., University College, Cardiff.
 Rev. GEORGE PIRIE, M.A., LL.D., Professor of Mathematics, University, Aberdeen.
- 115 A. J. PRESSLAND, M.A., F.R.S.E., The Academy, Edinburgh.
 HARRY RAINY, M.A., M.D., F.R.S.E., 16 Great Stuart Street, Edinburgh.
 THOS. T. RANKIN, C.E., B.Sc., Principal, Technical School and Mining College, Coatbridge.
 DAVID RENNET, LL.D., 12 Golden Square, Aberdeen.
 WILLIAM RITCHIE, F.R.A.S., City Observatory, Calton Hill, Edinburgh.
- 120 ALEX. D. RUSSELL, B.Sc., High School, Falkirk.
 CHARLOTTE ANGAS SCOTT, D.Sc., Professor of Mathematics, Bryn Mawr College, Pennsylvania, U.S.A.
 R. F. SCOTT, M.A., St John's College, Cambridge.
 RODERICK M. SHEARER, M.A., B.Sc., 30 Blackwood Crescent, Edinburgh.
 EDWARD SMART, B.A., B.Sc., The Academy, Perth.
- 125 DUNCAN Y. M. SOMERVILLE, M.A., B.Sc., Lecturer in Applied Mathematics, University of St Andrews.
 FRANK SPENCE, M.A., B.Sc., F.R.S.E., U.F. Church Training College, Edinburgh.
 T. B. SPRAGUE, M.A., LL.D., F.R.S.E., 29 Buckingham Terrace, Edinburgh.

- J. E. A. STEGGALL, M.A., Professor of Mathematics, University College, Dundee.
- ADAM B. STEWART, M.A., School of Agriculture, Ghizeh, Cairo, Egypt.
- 130 WALTER STOTT, Hon. Sec., Liverpool Mathematical Society, 4 Grasmere Drive, Liscard.
- JAMES STRACHAN, M.A., 137 Warrender Park Road, Edinburgh.
- JOHN G. SUTHERLAND, M.A., The Academy, Greenock.
- JAMES TAYLOR, M.A., F.R.S.E., The Academy, Edinburgh.
- W. S. TEMPLETON, M.A., B.Sc., Royal Indian Engineering College, Cooper's Hill, Englefield Green, Surrey.
- 135 J. A. THIRD, M.A., D.Sc., Spier's School, Beith (*President*).
- ANDREW THOMSON, M.A., D.Sc., F.R.S.E., The Academy, Perth.
- WM. THOMSON, M.A., B.Sc., F.R.S.E., Registrar to the Cape University, Cape Colony.
- W. L. THOMSON, M.A., George Heriot's School, Edinburgh (*Co-Editor of Proceedings*).
- JOHN TURNER, M.A., B.Sc., Royal High School, Edinburgh.
- 140 CHARLES TWEEDIE, M.A., B.Sc., F.R.S.E., Lecturer on Mathematics, University, Edinburgh (*Vice-President*).
- DAVID TWEEDIE, M.A., B.Sc., Ras-el-Tin Government School, Alexandria, Egypt.
- SAMUEL WALKER, M.A., D.Sc., George Heriot's School, Edinburgh.
- A. G. WALLACE, M.A., F.R.S.E., Headmaster, Central Public School, Aberdeen.
- W. WALLACE, M.A., F.R.S.E., Principal, Cockburn Science School, Leeds.
- 145 W. G. WALTON, F.F.A., Scottish Provident Office, 6 St Andrew Square, Edinburgh.
- T. P. WATSON, M.A., B.Sc., F.R.S.E., Principal, Technical College, Keighley, Yorkshire.
- JOHN C. WATT, M.A., Jesus College, Cambridge.
- JAMES MACPHERSON WATTIE, M.A., B.A., H.M.I.S. "Earls-mount," Fife-Keith, Banffshire.
- J. H. MACLAGAN WEDDERBURN, M.A., University, Edinburgh.
- 150 JOHN WEIR, M.A., Professor of Mathematics, Mysore, India.
- WILLIAM WELSH, M.A., Jesus College, Cambridge.
- JOHN W. WHITE, Lorne Street Public School, Leith.
- WM. WYPER, C.E., 10 Highbury Terrace, Dowanhill, Glasgow.
- W. YOUNG, F.F.A., 19 George Street, Edinburgh.

The following Presents to the Library have been received, for which the Society tenders its grateful thanks.

1. Proceedings of the London Mathematical Society.
Nos. 790-813.
2. Memoirs and Proceedings of the Manchester Literary and Philosophical Society.
Parts as issued.
3. Proceedings of the Cambridge Philosophical Society.
Vol. XI., 6-7 ; Vol. XII., 1.
4. Bulletin of the American Mathematical Society.
Second Series.—As issued.
5. Transactions of the American Mathematical Society.
As issued.
6. Annals of Mathematics. Published under the auspices of the University of Virginia.
Vol. IV. of Second Series—Nos. 1-4.
7. Proceedings of the American Philosophical Society (Philadelphia).
As issued.
8. Mathematical Gazette. Nos. 33-40.
9. Annales de la Faculté des Sciences de Marseille.
Tome XIII.
10. Bulletin de la Société Mathématique de France.
Vol. XXX.—Nos. 3, 4. Vol. XXXI., No. 1.
11. Journal de Mathématiques Élémentaires.
Publié par M. H. VUIBERT.
As issued.
12. Revue Générale de Bibliographie Française.
Vol. I. No. 1.

13. **Communications de la Société Mathématique de Kharkow.**
Tome VII. Parts 2-6.
14. **Mathematisch-naturwissenschaftliche Mitteilungen im Auftrag des
mathematisch-naturwissenschaftliche Vereins in Württemberg.**
Zweite Serie. Fünfter Band. Erstes Heft.
15. **Revue Semestrielle des Publications Mathématiques.** Published
under the auspices of the Mathematical Society of Amsterdam.
Vol. XI. Parts 1, 2.
16. **L'Enseignement Mathématique, IV. Année. No. 5.**
17. **Mémoires de la Société Royale des Sciences de Liège.**
Troisième Série. Tom IV.
18. **Tōkyō Sūgaku-Buturigaku Kwai Kizi.**
Maki No. IX., Dai 1.
19. **Jornal de Sciencias Mathematicas e Astronomicas.**
Publicado pelo Dr F. GOMES TEIXEIRA.
Vol. XIV.—No. 6. Vol. XV.—Nos. 1-2.
20. **Rendiconti del Circolo Mathematico di Palermo.**
Tomo XVI. and XVII.—Nos. 1-3.
21. **Wiskundige Opgaven met de Oplossingen.**
Nieuve Reeks—Achtste Deel—1899-1902.
22. **Revue de mathématiques publiées par G. PEANO.**
23. **Bulletin de la Société Physico-Mathématique de Kasan.**
Deuxième Série. Tome XII.—4.
XIII.—1.
24. **Problème de Géométrie by M. Éd. COLLIGNON, Paris.**
25. **On some curves connected with a system of similar conics, by
Professor R. E. ALLARDICE.**
26. **Exposé synthétique des Principes Fondamentaux de la Nomographie,
by M. MAURICE D'OCAGNE, Paris.**

Fig. 4

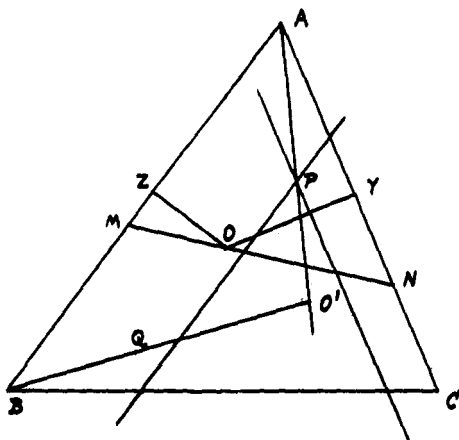

Fig. 5

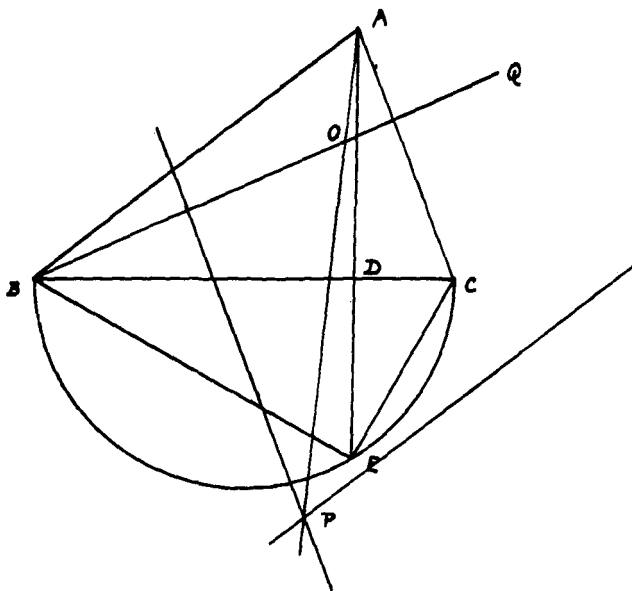

Fig. 6

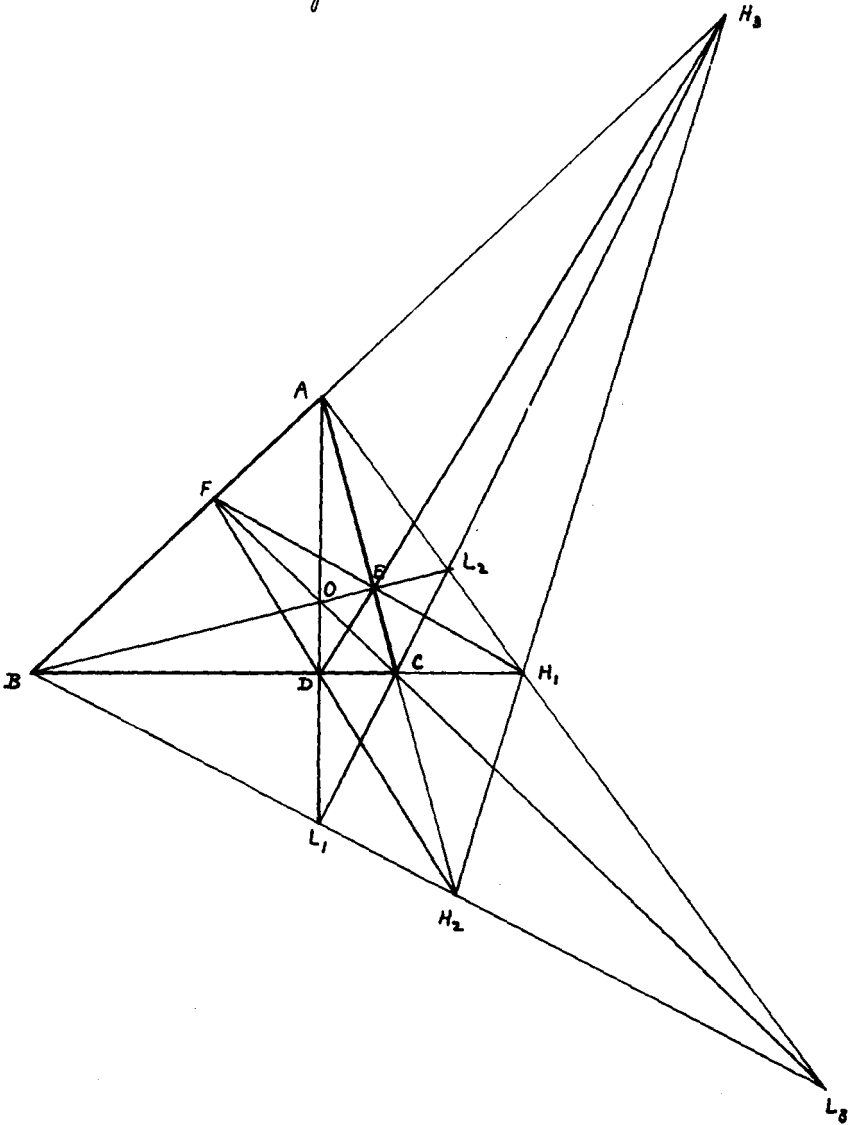
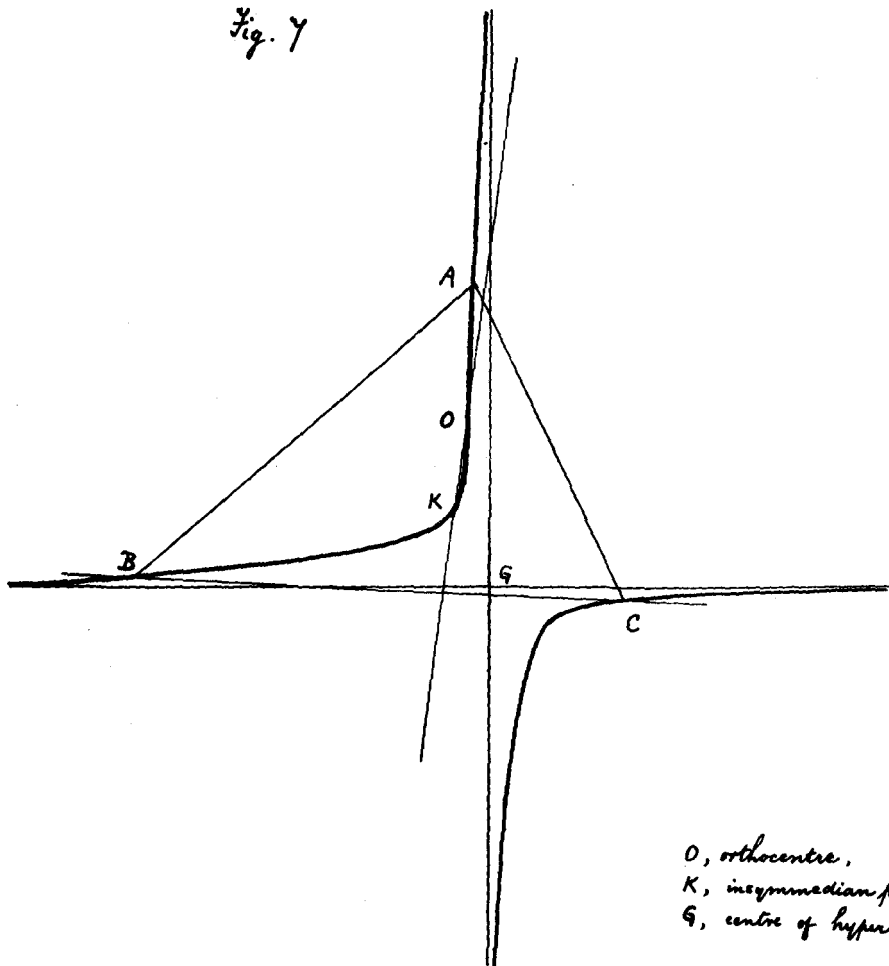

Fig. 7



O, orthocentre,
K, isosymmedian point,
G, centre of hyperbola.

Fig. 8.

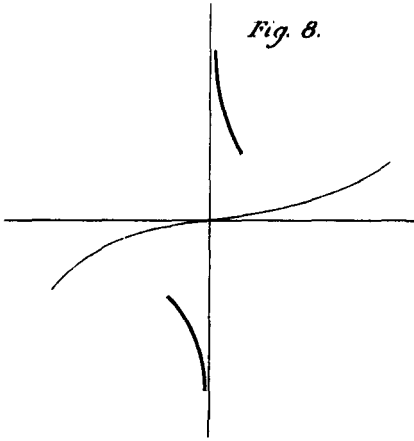

Fig. 9.

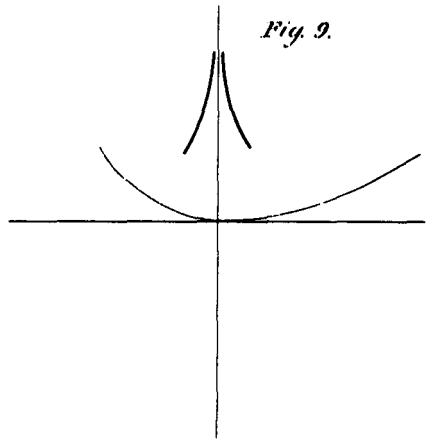

Fig. 10.

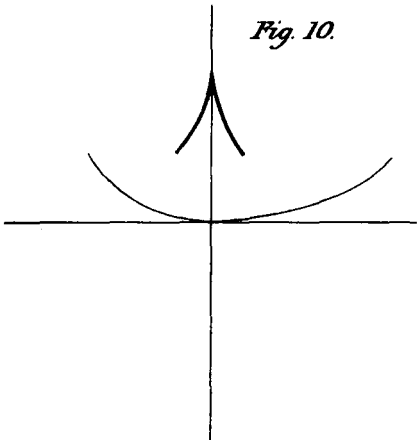

Fig. 11.

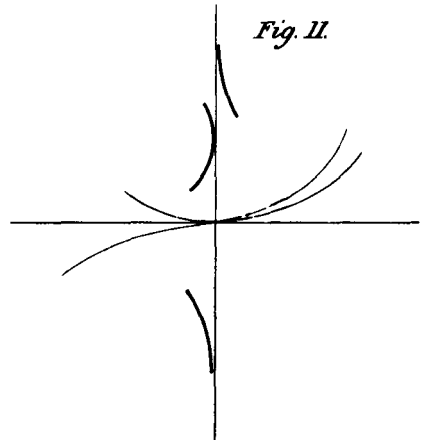

Fig. 12.

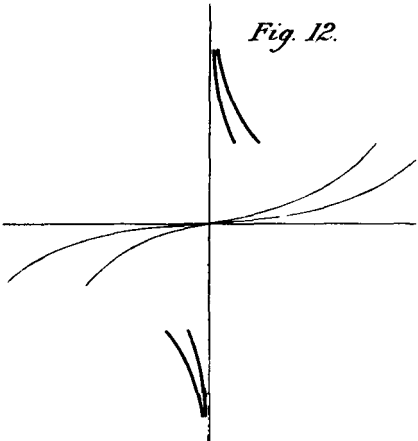
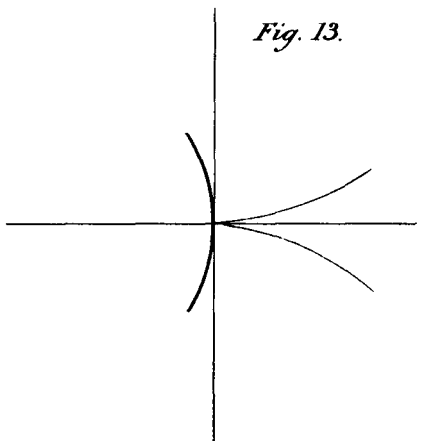

Fig. 13.



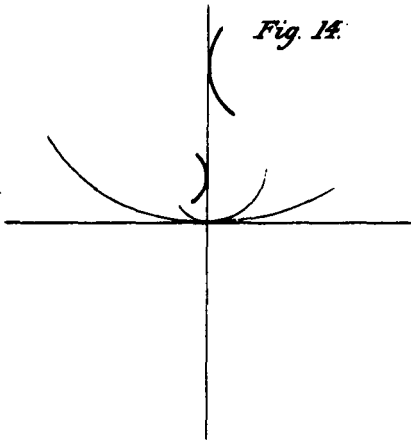

Fig. 14.

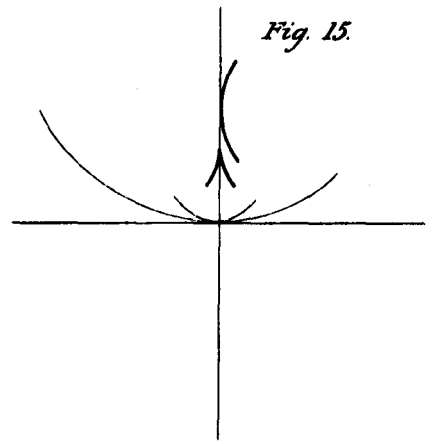

Fig. 15.

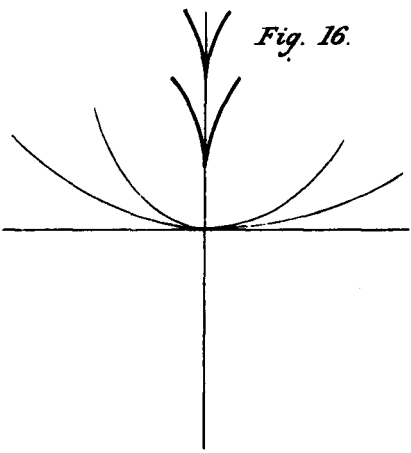

Fig. 16.

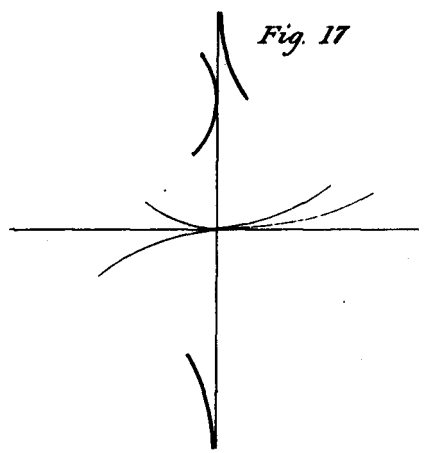

Fig. 17.

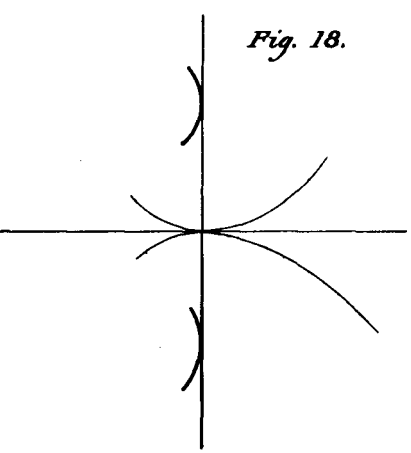

Fig. 18.

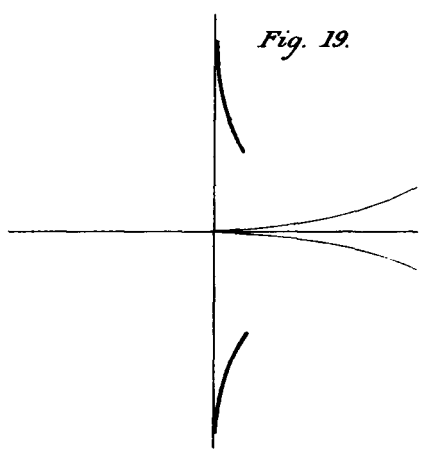

Fig. 19.

Fig. 20.

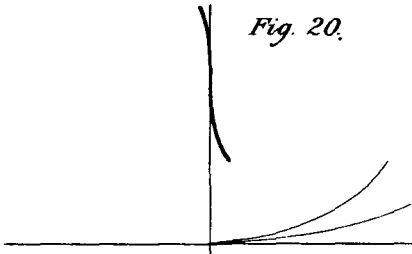

Fig. 21.

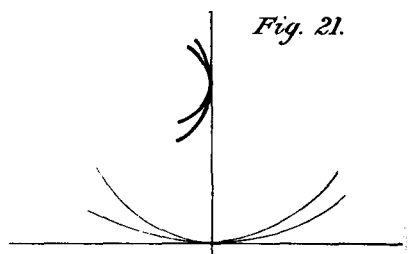

Fig. 22.

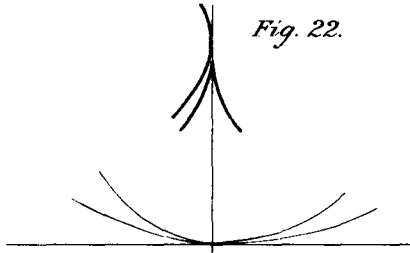

Fig. 23.

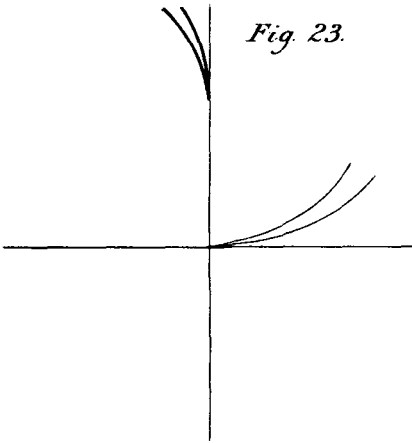

Fig. 24.

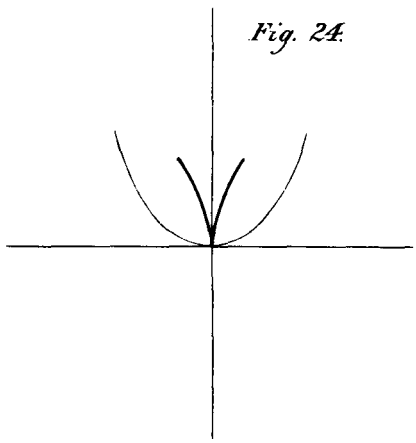

Fig. 25.

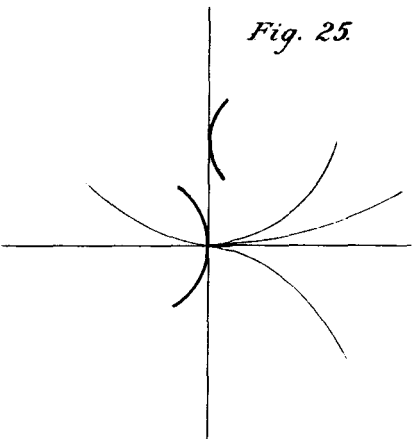

Fig. 26.

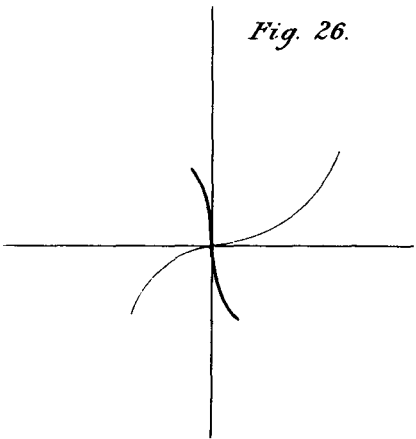

Fig. 27.

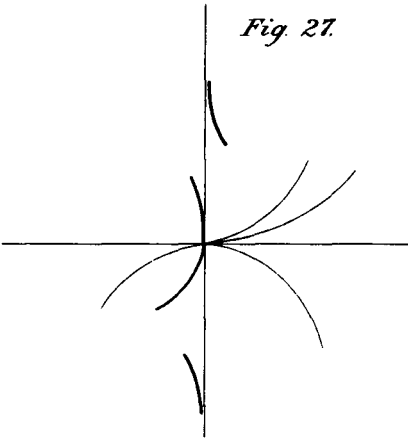

Fig. 28.

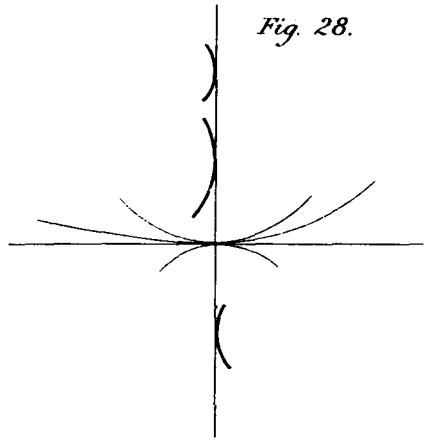

Fig. 29.

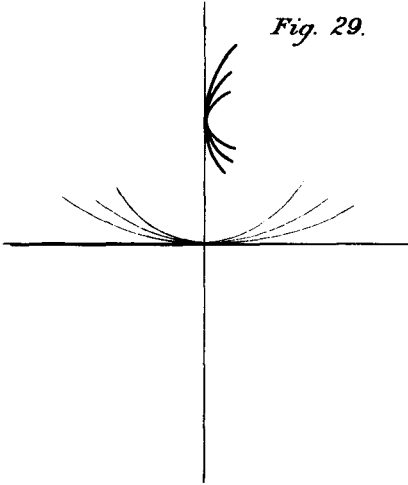

Fig. 30.

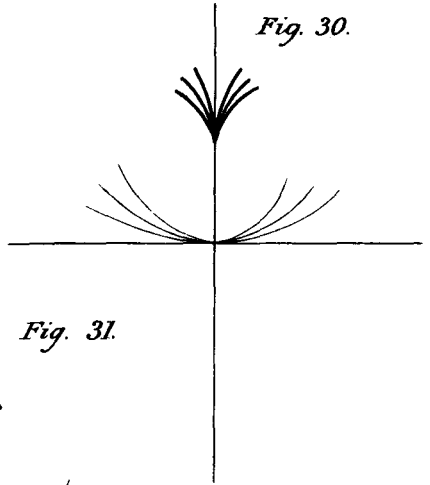

Fig. 31.

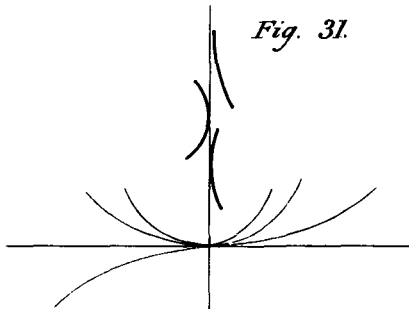

Fig. 32.

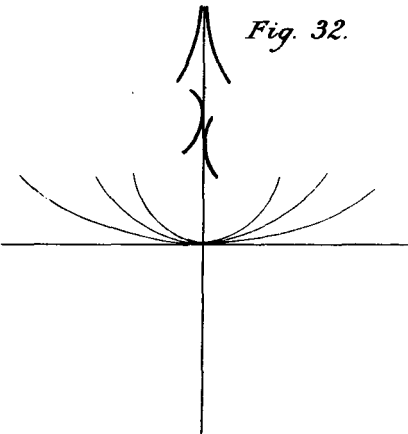

Fig. 33.

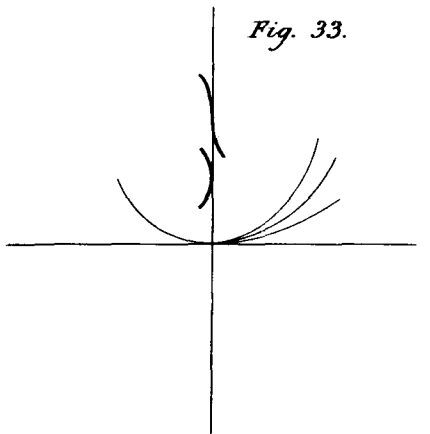

Fig. 34.

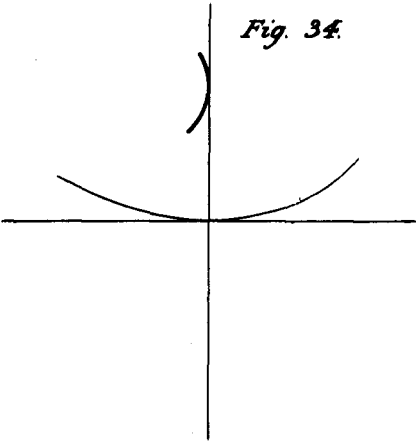

Fig. 35.

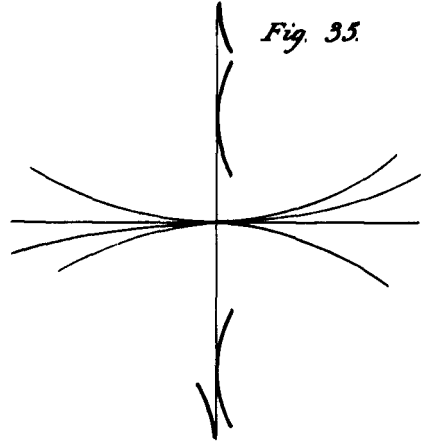

Fig. 36.

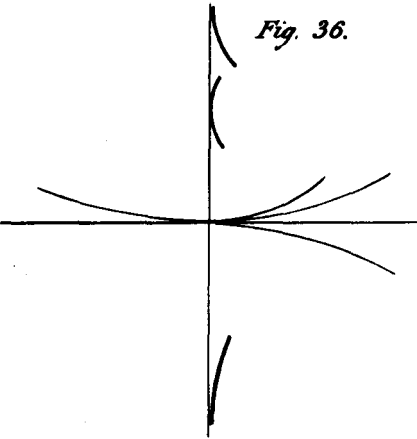

Fig. 37.

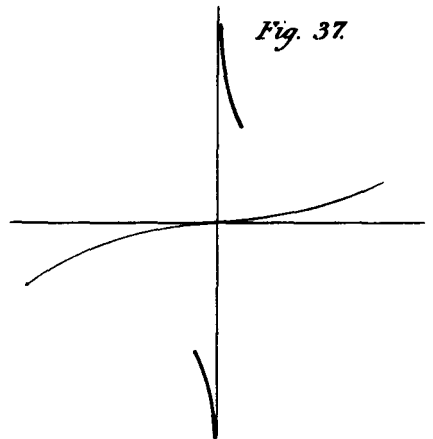

Fig. 38.

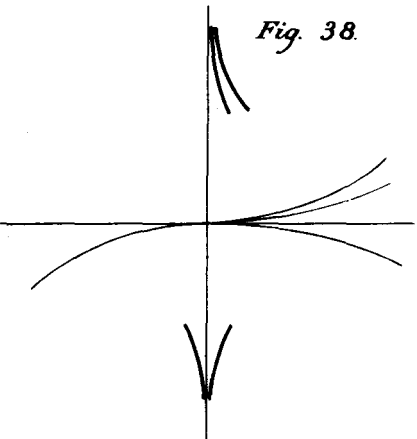

Fig. 39.

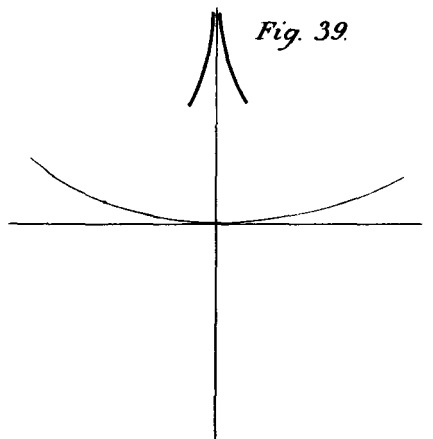

Fig. 40.

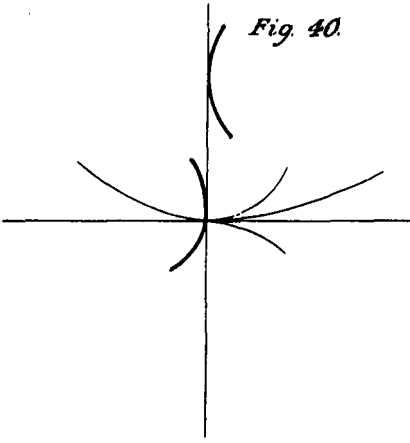

Fig. 41.

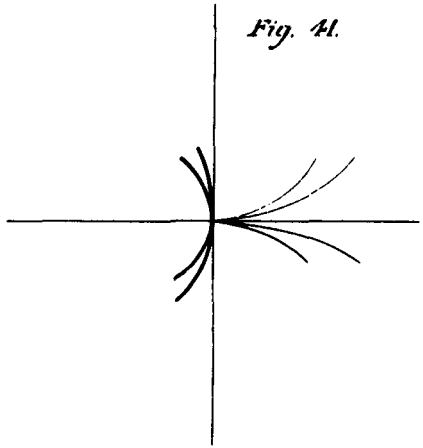

Fig. 42.

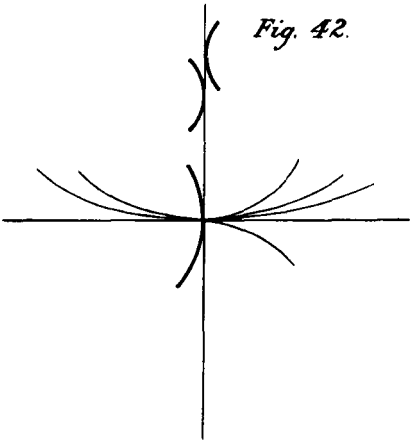

Fig. 43.

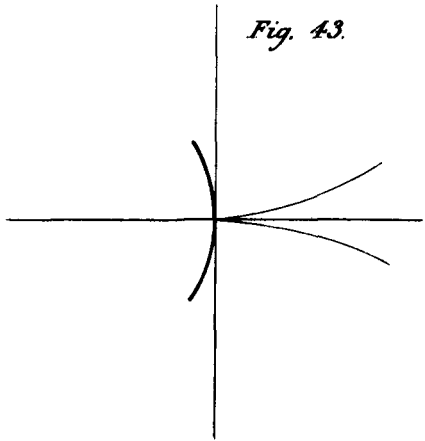

Fig. 44.

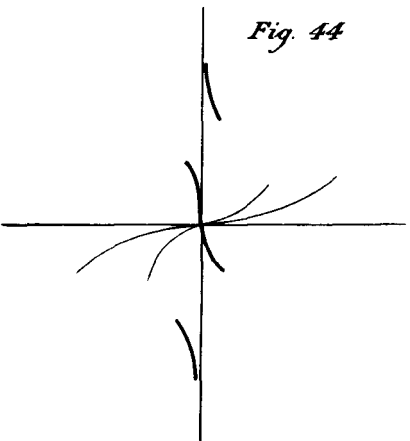
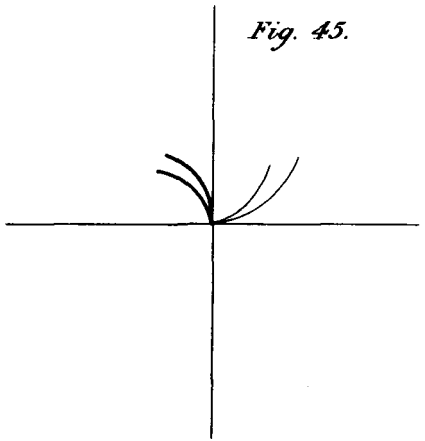

Fig. 45.



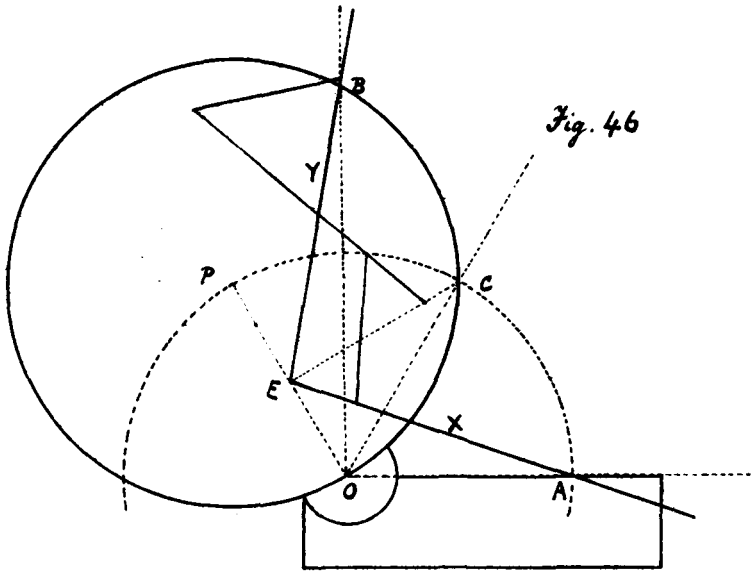

Fig. 46

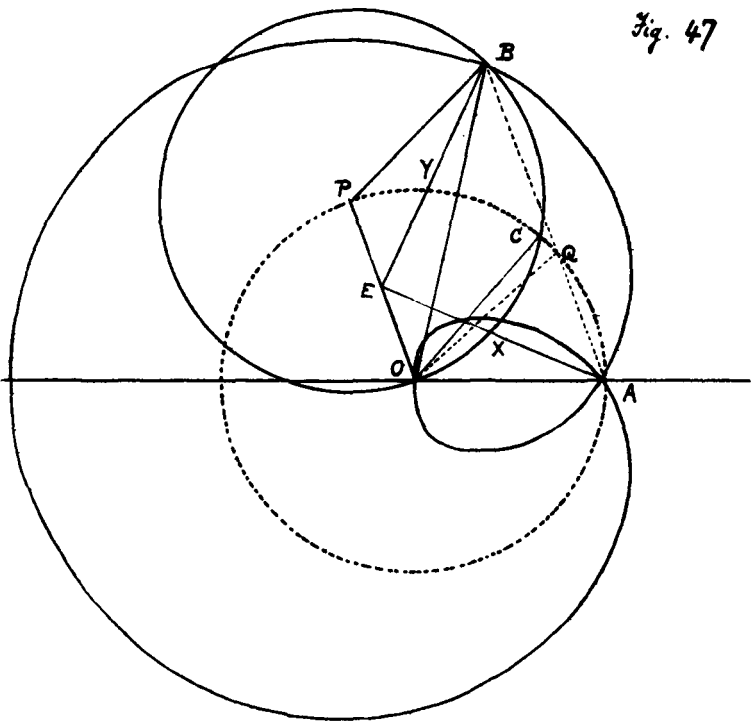
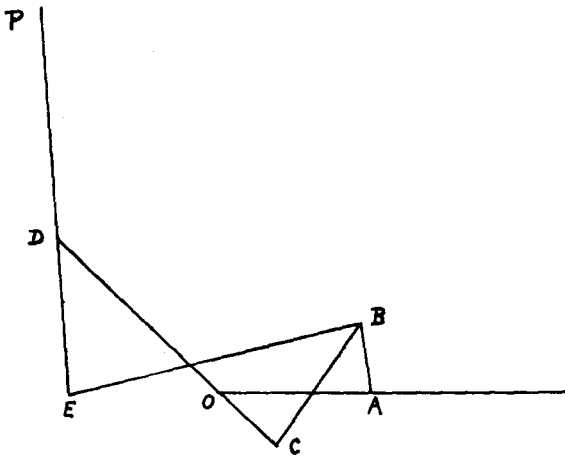

Fig. 47

Fig. 48



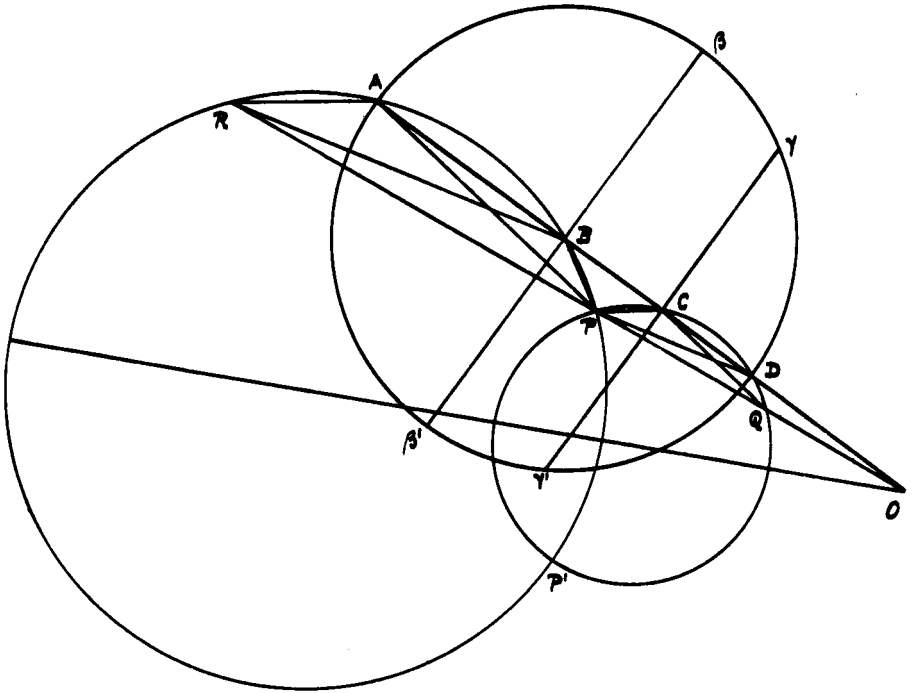

Fig. 49

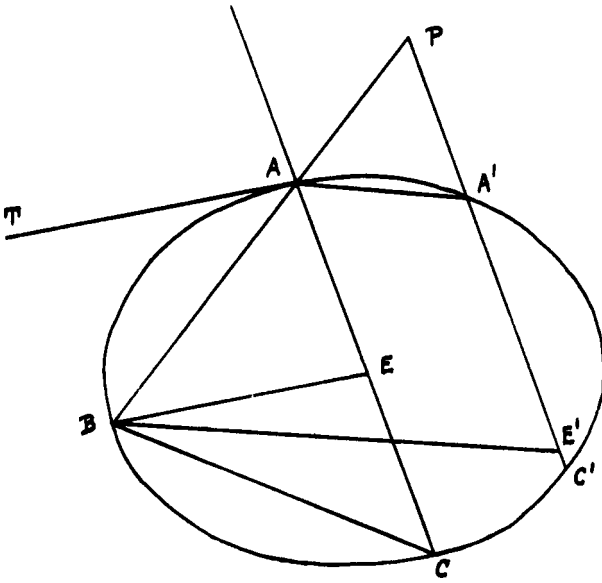

Fig. 50

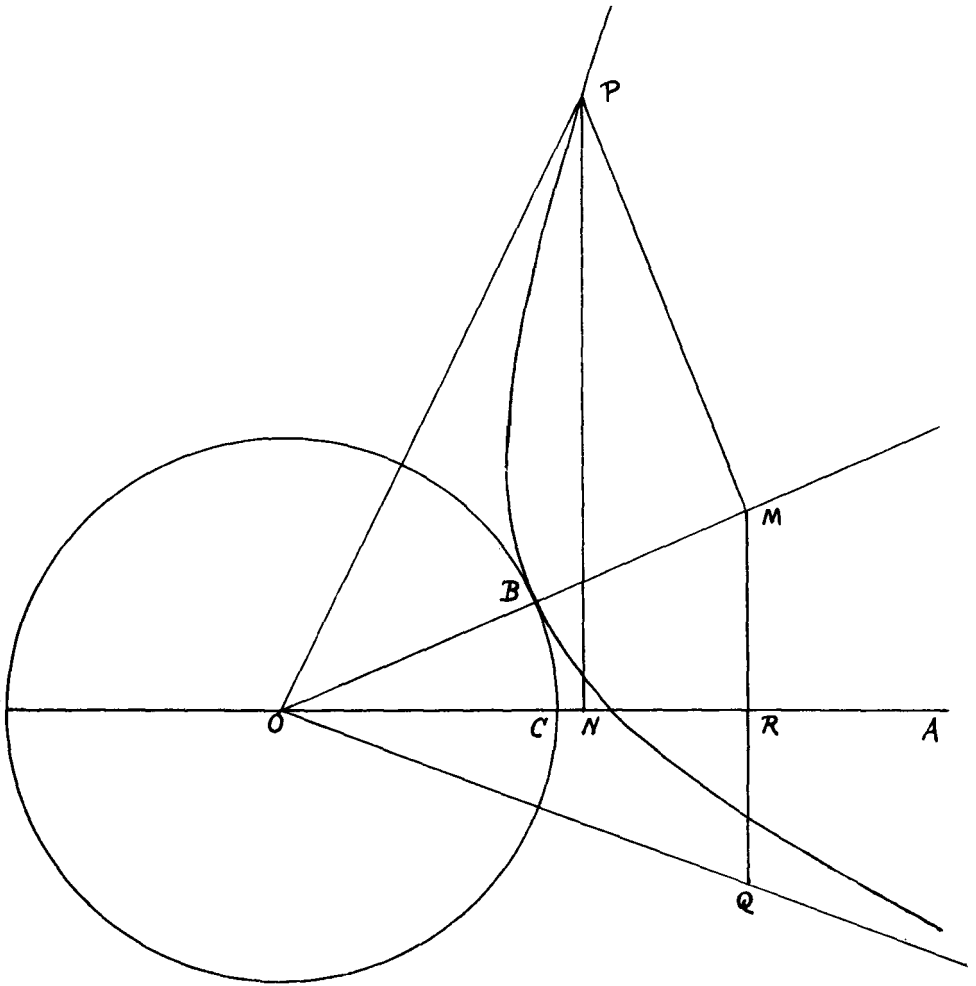

Fig. 51