

The Reactivity of Canine Cerebral Arteries to O₂ and CO₂ in Vitro

P. STEINBOK, M. J. KENDALL, R. J. CLARKE AND S. J. PEERLESS

SUMMARY: *The responses of canine middle cerebral arteries to changes in pCO₂ and pO₂ were tested in vitro. It was found that there was no response to changes in pCO₂ from 38.1 mm. Hg to 26.6 mm. Hg, but there was some constriction of the vessels with lowering of the pCO₂ below 26.6 mm. Hg and there was minimal dilatation of the vessels when the pCO₂ was increased from 38.1 mm. Hg to 87.2 mm. Hg. There was no*

response to changes in pO₂ from more than 500 mm. Hg to 59.6 mm. Hg, but when pO₂ was lowered below 50 mm. Hg there was a sudden, massive constriction of the arteries tested. It is postulated that this constriction is due to build-up of a substance (substances) during a period of hypoxia (pO₂ < 50 mm. Hg). The significance of the results obtained are discussed.

RÉSUMÉ: *Les réponses des artères cérébrales médianes des chiens aux changements aux pCO₂ et pO₂ furent vérifiées in vitro. Il fut trouvé qu'il n'y avait pas de réponse aux changements de pCO₂ de 38.1 mm Hg à 26.6 mm Hg, mais qu'il y avait constriction des vaisseaux avec une baisse de pCO₂ en-dessous de 26.6 mm Hg et une dilatation minimale des vaisseaux quand le pCO₂ était augmenté de 38.1 mm Hg à 87.2 mm Hg. Il n'y avait pas de ré-*

ponse aux changements de pO₂ de plus de 500 mm Hg à 59.6 mm Hg, mais quand pO₂ descendait sous 50 mm Hg, il y avait une constriction massive et soudaine des artères. Il est postulé que cette constriction est due à l'accumulation d'une ou des substances durant la période d'hypoxie (pO₂ < 50 mm Hg) et que la substance impliquée est probablement un produit du métabolisme anaérobique.

INTRODUCTION

It is now generally accepted that cerebrovascular resistance is regulated by a combination of nervous and humoral factors (Betz, 1972; Meyer and Welch, 1972; Reivich, 1969). However, the mechanisms whereby these factors affect the cerebral vessels, and their relative significance are unclear.

There is no doubt that cerebral vessels are richly innervated with both sympathetic and parasympathetic fibers (Sundt, 1973; Peerless and Kendall, 1975). This was originally demonstrated by Chorobski and Penfield (1923) and Penfield (1932) using the light microscope, and has been confirmed more recently using fluorescent microscopic techniques (Nielsen and Owman, 1967; Falck et al, 1968; Lavretieva et al, 1968; Peerless and Yasargil, 1971; Peerless et al, 1972), and electron microscopy (Nelson and Rennels, 1970; Nielsen et al, 1971).

The functional significance of these nerves is not known. Stimulation and transection of the nerves have produced variable responses, suggesting that the direct effect of the nervous system on cerebrovascular resistance is minimal (Chorobski and Penfield, 1932; Forbes et al, 1939; Dumke and Schmidt, 1943; Gurdjian et al, 1958; Meyer et al, 1967). More recently it has been shown that both sympathetic and parasympathetic nerves modulate the effect of carbon dioxide on cerebral blood flow (James et al, 1969; Harper et al, 1971). The quantitative significance of this is not certain and it is thought that humoral factors including pCO₂, pO₂ and pH are of greater importance

From the Division of Neurosurgery, Department of Surgery, University of British Columbia, Vancouver, British Columbia, Canada.

Reprint requests to Dr. Paul Steinbok, University of British Columbia, Department of Surgery, 700 West 10th Ave., Vancouver V5Z 1L5 Canada.

in the regulation of cerebrovascular resistance.

Kety and Schmidt (1948) showed that inhalation of CO₂ caused increased cerebral blood flow in man, whilst hyperventilation with its associated hypocarbia produced decreased cerebral blood flow. These findings have been confirmed (Reivich, 1964; Meyer et al, 1967).

The mechanism of action of CO₂ on the cerebral blood vessels is not clear. It has been established by Severinghaus and Lassen (1967) (1968) that the arterial pCO₂ and not the venous or tissue pCO₂ is important in regulating cerebrovascular resistance. Earlier workers Sokoloff (1960) and Wolff (1936) suggested that CO₂ had a direct effect on cerebral arterial muscle, and, as evidence they cited the work of Cow (1911) who showed that isolated strips of carotid arteries immersed in Ringer's solution dilated when the pCO₂ of the solution was increased. Furthermore, the effect of CO₂ on cerebral blood flow was not abolished by spinal transection, section of 6th, 7th, 8th, and 10th cranial nerves, cervical sympathectomy, removal of the carotid sinus or decerebration, lending support to a possible direct effect of CO₂.

However, it has been shown by Betz (1965), Severinghaus (1965) and Severinghaus et al (1966) that the direct effect of CO₂ on the cerebral vessels cannot be the sole mechanism for the responses of the cerebral vessels to changes in pCO₂. During acclimatization to high altitudes hypocarbia occurs, and with it there is a decrease in cerebral blood flow, but after six to twelve hours the cerebral blood flow returns to normal despite a persistent decreased arterial pCO₂. It was noted that there was an initial increase in CSF pH with hypocarbia, but after a few hours the CSF pH returned to normal, so that the cerebral blood flow seemed to parallel the CSF pH rather than the arterial pCO₂. Similarly, with chronic hypercarbia in animals (Betz 1965) there was an initial increase in cerebral blood flow, but the cerebral blood flow returned to normal in a few hours, again reflecting the

changes in the CSF pH which initially decreased but then returned to normal in a few hours.

It has, therefore, been suggested that the effect of changes of pCO₂ on cerebral blood flow are mediated via changes in the CSF pH which reflected the brain extracellular fluid pH.

The effect of changes of pO₂ on cerebrovascular resistance have been well documented. Hypoxia has been shown to cause dilatation of the cerebral vessels with increased cerebral blood flow whilst hyperoxia produces the opposite effect (Kety and Schmidt), 1948; Meyer and Gotoh, 1961; Reivich, 1968; Betz, 1972).

The mechanism whereby changes in pO₂ affect the cerebral blood flow is not fully understood. A direct effect of O₂ on cerebral vessels has been reported Sokoloff (1959) but it is thought that this is not the only mechanism. Attempts have been made to relate the effects of O₂ on cerebral blood flow to the jugular venous pO₂, and it has been shown that as the jugular venous pO₂ fell below 30 mm. Hg, cerebral blood flow increased, and at a "critical" jugular venous pO₂ of 19-20 mm. Hg disturbance of brain function occurred (Meyer et al, 1965).

It was thought that receptors in the jugular veins responded to changes in jugular venous pO₂ so that cerebral hypoxia with decreased venous pO₂ resulted in increased cerebral blood flow and correction of the hypoxia in the brain. However, there is much evidence against this concept. Following transient occlusion of an intracerebral artery there is reactive hyperemia when the occlusion ceases, and despite the fact that the jugular venous pO₂ is elevated, increased cerebral blood flow occurs. Furthermore, in the region of an ischemic area of brain due to vascular occlusion, there often occurs a region of excess blood flow producing the so-called "luxury perfusion syndrome" (Lassen, 1966). In this region the pO₂ is elevated and so is the cerebral blood flow, whilst perfusion may be normal in other areas of the brain. Finally, in chronic hypoxia, the cerebral blood flow ini-

tially increases, but later returns to normal despite the maintenance of the hypoxic state.

In order to explain the response to chronic hypoxia, it has been suggested that hypoxia produces lactic acidosis with an associated decrease in CSF pH and brain extracellular fluid pH, and these changes may be responsible for the changes in cerebral blood flow. This is one of the most attractive hypotheses as to the mechanism of action of O₂ changes on cerebral blood flow, and certainly in chronic hypoxia the cerebral blood flow does parallel the CSF pH. However, it is also possible that the adaptation to chronic hypoxia is due to changes in high energy phosphates in cerebral tissue, notably increased ATP production via anaerobic pathways (Dahl and Balfour, 1964; Detar and Bohr, 1968).

The effect of pH changes on the cerebral blood is also controversial. It is generally accepted that acidosis causes increased cerebral blood flow and alkalosis causes decreased cerebral blood flow (Sokoloff, 1959) although some earlier workers had reported conflicting results (Bronk and Gesell, 1927; Schieve and Wilson, 1953).

The mechanisms whereby pH changes affect cerebral blood flow have been difficult to elucidate, largely because changes in acid-base balance are associated with other metabolic variations, mainly changes in pCO₂. By separating the effects of arterial pH and pCO₂ it has been shown that changes in arterial pH affect cerebral blood flow indirectly via changes in arterial pCO₂ and secondary alterations in the pCO₂ and pH of the cerebrospinal fluid and brain extracellular fluid (Lambertsen et al, 1961; Harper and Bell, 1963; Betz and Heuser, 1967).

There is still much controversy regarding the regulation of cerebrovascular resistance by nervous and humoral factors. The humoral mechanisms seem to be the more important, but the significance of nervous mechanisms, especially in modulating the responses to the humoral factors, is becoming more established. The basic mechanisms

whereby arterial pH, pCO₂ and pO₂ affect cerebrovascular resistance are not completely resolved, but the most acceptable mechanism is an indirect effect via changes in acid-base balance within the brain. There are undoubtedly direct effects of pH, pCO₂ and pO₂ on the cerebral arteries, and these have been poorly documented.

The present study was designed to investigate the direct effects of CO₂ and O₂ on the cerebral arteries, using an *in vitro* preparation of canine middle cerebral arteries. Although it can be argued that results obtained by *in vitro* methods are not strictly applicable to the *in vivo* situation, it is only by an *in vitro* method that one can eliminate extrinsic influences on the responses of the vessels under study.

Two basic methods have been used to study the reactivity of isolated vascular smooth muscle. Direct recording of changes in tension or length of strips or rings of vessels, and measurement of resistance in an isolated perfused blood vessel by recording changes in pressure or flow. Although these techniques have been used extensively in the study of various circulatory beds, the cerebral circulation was not investigated by these *in vitro* methods until 1961, when Bohr, Goulet and Taquini reported on direct tension recording from various resistance vessels, including cerebral arteries. In this series of experiments, helical strips of cerebral arteries were used and the reactivity to various drugs was tested. Uchida, Bohr and Hoobler (1967) used preparations of isolated perfused cerebral arteries to study the effects of drugs on the cerebral vessels, and Nielsen and Owman (1971) and Allen et al. (1974) studied the effect of vasoactive agents on isolated segments of cerebral arteries by recording changes in intraluminal tension of the arterial preparation.

In the current study we have investigated the effects of O₂ and CO₂ on the reactivity of cerebral arteries *in vitro*, using the method described by Nielsen and Owman (1971) and Allen et al. (1974). By using segments of arteries one can measure the ra-

dial contraction of the arterial segment, which is more physiological than measuring the tension developed in the helical strip of the artery and is, therefore, more likely to yield results applicable to the *in vivo* situation.

METHOD

a) Material

The subjects were 17 adult mongrel dogs ranging in weight from 15 kg. to 24 kg. The dogs were given a lethal dose of pentobarbitone sodium (Nembutal) and the brains immediately removed.

b) Vessel preparation

The vessels of the circle of Willis were immediately dissected out and placed in Krebs-Ringer-glucose solution having the following composition: NaCl 120 mM, KCl 4.5 mM, CaCl₂·2H₂O 2.5 mM, MgSO₄·7H₂O 1.0 mM, NaHCO₃ 27 mM, KH₂PO₄ 1.0 mM, glucose 3.0 mM. The vessels were stored at 4°C, until used, and all vessels were used within 16 hours after death of the animal.

Thirty segments of the middle cerebral arteries, each measuring 2 to 4 mm. in length were tested. The segment of artery to be tested was placed in a 50 ml. plexiglass well containing Krebs-Ringer-glucose solution (composition above), which was maintained at a temperature of 38.0°C by an outer jacket of circulating water, heated by a thermostatically controlled circulation pump. The vessel was mounted in a rigid system, consisting of two stainless steel rods passing through the lumen for its entire length. One rod was fixed to the wall of the plexiglass well, and the other rod was connected to a strain gauge, so that the radial contraction of the vessel segment could be measured, as described (Allen et al. 1974; Nielsen and Owman, 1971) (Fig. 1). Since the only factors affecting the tension measured by the strain gauge were the changes in the diameter of the mounted vessel segment, the method allowed an indirect assessment of changes in the caliber of the vessel segment. The artery was placed under a tension of 3-6.5 gm. and allowed to relax for a period of 30-60 minutes to a baseline tension

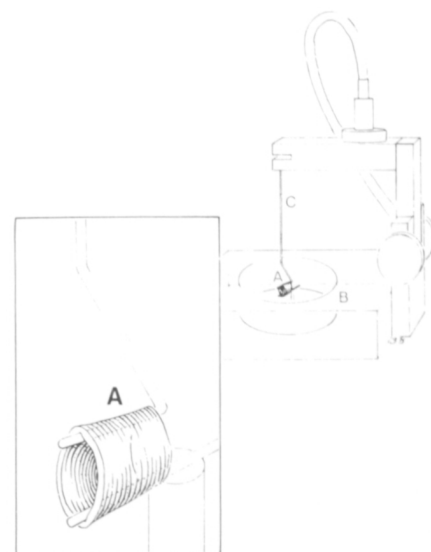

Figure 1—Simplified diagram of apparatus used for measuring radial contractions of middle cerebral artery preparations. B = Plexiglass well, A = vessel segment mounted on two rods, the upper rod C being attached to a strain gauge.

of between 130 and 700 mg. Only those vessels which displayed a stable baseline were tested.

c) Changes in pO₂ and pCO₂

The pO₂ and pCO₂ of the solution were regulated by bubbling a gas mixture into the solution via a 21 gauge needle. Gas mixtures were available for varying the pCO₂ independent of changes in pO₂, and these included 2%, 4%, 5%, 6%, 8% and 13% CO₂ in compressed air, i.e. 21% O₂. Gas mixtures were also available for varying the pO₂ without changing the pCO₂, and these included 0%, 7%, 15%, 21% and 95% O₂ in 5% CO₂. In addition there was a gas mixture containing 2% CO₂ and 0% O₂, which allowed a low pCO₂ and a low pO₂ to be produced simultaneously.

d) Measurements

i) Vessel contraction

The radial contraction of the arterial segment was recorded by means of a Grass force displacement transducer. Somborn preamplifier and modified XY plotter. The system was capable of recording a change in tension of 10 mg. or more.

ii) pH, pCO₂, pO₂

Samples of the solution were

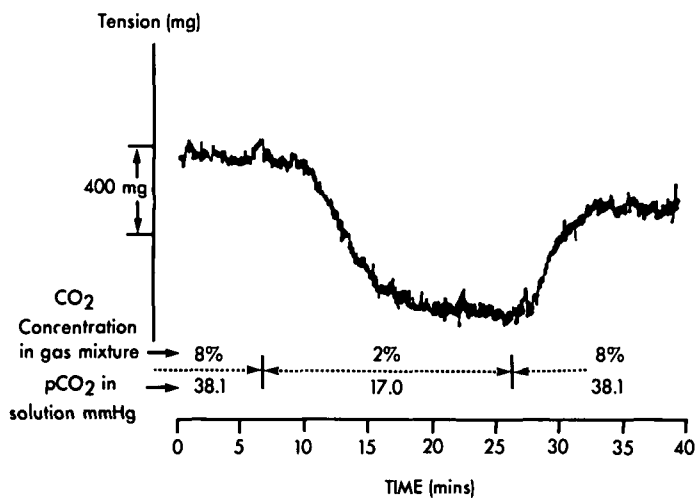

Figure 2—Typical response to a change of the pCO₂ in the solution. A downward deflection of tension tracing represents increased tension and a constriction of the vessel.

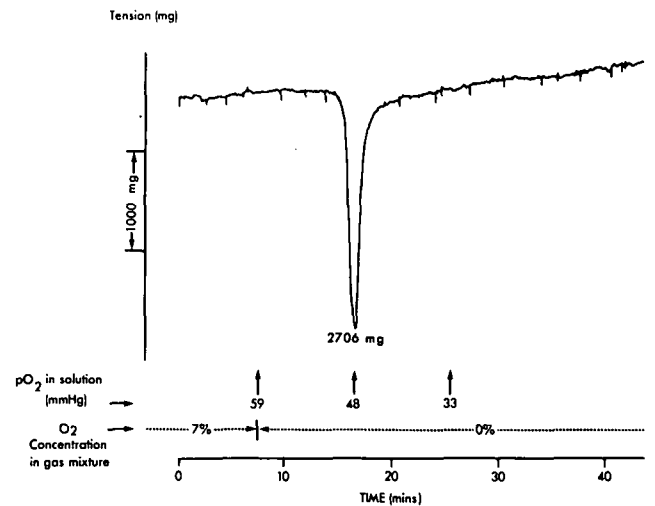

Figure 4—Typical response to a change of pO₂ to a level < 50 mm. Hg. A downward deflection of the tension tracing represents constriction of the vessel.

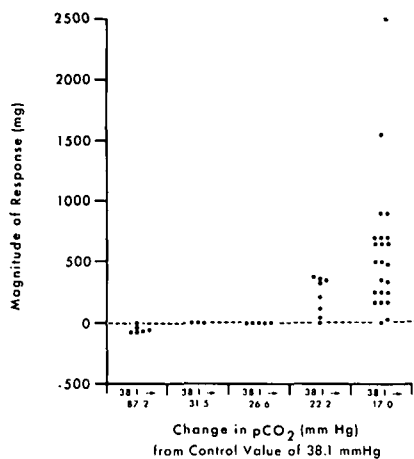

Figure 3—Magnitude of the responses observed with changes of the pCO₂ in the solution from the control pCO₂ of 38.1 mm. Hg. A positive value represents a constriction, whilst a negative value represents dilatation of the vessel.

removed from the plexiglass well at 5 minute intervals for measurement of pH, pCO₂ and pO₂; and the samples were analyzed using an Astrup blood gas analyzer.

RESULTS

Effect of CO₂

Using normoxic solutions, the pCO₂ was varied from 17.0 mm. Hg to 87.2 mm. Hg (Table 1), and this was associated with pH changes from 7.60 to 6.95. A change of pCO₂ was accompanied by a change in the

intraluminal tension of the vessel tested. Increasing the pCO₂ caused dilatation and decreasing the pCO₂ caused constriction. There was a latency of approximately 5.4 minutes (average of all values) before a response was noted, followed by a gradual change towards a new baseline over a period of approximately 20 minutes. Return to the original pCO₂ was accompanied by a reversal of these changes (Fig. 2).

There was no change in the intraluminal tension of the vessel with changes of pCO₂ between 26.6 mm. Hg and 38.1 mm. Hg. Below 26.6 mm. Hg there was increasing constriction of the vessel with progressive lowering of the pCO₂ to 17 mm. Hg, whereas changing the pCO₂ from 38.1 mm. Hg to 87.2 mm. Hg was accompanied by dilatation of the vessel (Fig. 3).

The constriction of the vessel with changes of the pCO₂ from the control value 38.1 mm. Hg to a lower pCO₂, e.g. 17.0 mm. Hg, was much greater than the dilatation observed with change of the pCO₂ from 38.1 mm. Hg to 87.2 mm. Hg. This may reflect the fact that the vessel at rest is almost fully dilated, so that it can dilate only a small amount. However, full dilatation is probably not produced by a pCO₂ of 87.2 mm. Hg, because, if xylocaine 20 mg. is added to the bath after a pCO₂ of 87.2 mm. Hg has produced dilatation, further dilation of the vessel does occur,

although the response is also of small magnitude.

Effect of O₂

Using a constant pCO₂ level of approximately 26.6 mm. Hg, the pO₂ levels of the solution were changed by using gas mixtures with varying O₂ concentrations, according to Table 2. Changes in pO₂ from > 500 mm. Hg to 59.7 mm. Hg had no effect on the intraluminal tension of the middle cerebral arteries tested. How-

TABLE 1
Showing pCO₂ Changes in Solutions with Varying Gas Concentrations of CO₂

CO ₂ % in Gas Mixture	pCO ₂ in Solution Mean ± Standard Deviation (mm. Hg)
2	17.0 ± 1.38
4	22.3 ± 1.18
5	26.6 ± 2.80
6	31.5 ± 1.15
8	38.1 ± 2.87
13	87.2 ± 15.93

TABLE 2
Showing pO₂ Changes in Solution with Varying Gas Concentrations of O₂

O ₂ in Gas Mixture	pO ₂ in Solution Mean ± standard Deviation (mm. Hg)
0	28.7 ± 5.0
7	59.7 ± 8.4
15	108.0 ± 3.7
21	135.0 ± 8.8
95	> 500

TABLE 3
Duration of Response Following
Change of pO₂ in Solutions

Number	Change in pO ₂ (mm. Hg)	Duration of Response (min) ± Standard Deviation
2	500 → 28.7	6.31 ± 621
17	135 → 28.7	9.01 ± 3.66
6	108 → 28.7	9.10 ± 4.04
10	59.7 → 28.7	6.53 ± 1.73

ever, on reducing the pO₂ of the solution towards 28.7 mm. Hg by using the gas mixture containing 0% O₂, a strong constriction of the vessel was noted, and this response occurred when the pO₂ was between 40 mm. Hg and 50 mm. Hg.

The typical response to these low levels of pO₂ was a sudden large constriction, with a duration of 2 minutes to 17 minutes, followed by a return to a prehypoxic baseline tension even though the pO₂ remained low (Fig. 4). The duration of the response was quite variable and did not depend on the original level of the pO₂ before hypoxia was induced (Table 3). Furthermore, no matter what the original pO₂ was, the magnitude of the constriction in response to hypoxia was similar (Fig. 5). In a single preparation, repeated lowering of the pO₂ would produce

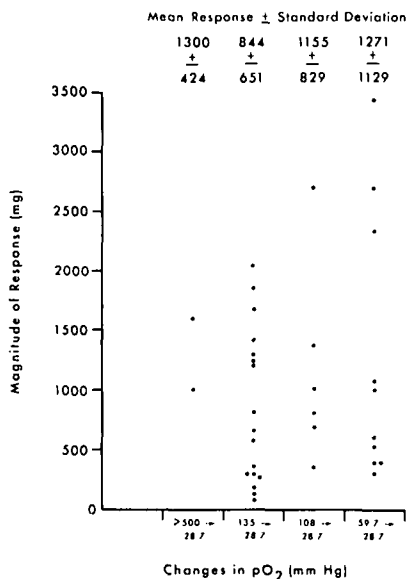

Figure 5—Response to changes of pO₂ in the solution from different levels to a value of < 50 mm Hg.

progressively larger contractions, and in some vessels responses occurred only after the second and subsequent reductions of the pO₂. This suggests that hypoxia sensitizes the artery, so that repeated episodes of hypoxia cause larger contractions of the artery.

It is interesting to note that the contraction in response to hypoxia was short-lived, and that the artery relaxed to the original base-line tension following a brief constriction, despite maintenance of a low pO₂. A possible explanation is that the artery responds only to a change in pO₂ towards a value of < 50 mm. Hg, and does not respond to hypoxia per se. Another explanation why the contraction is not maintained is that the energy sources required for contraction are rapidly utilized by hypoxic levels and cannot be re-synthesized without adequate O₂. The evidence is in favour of the latter explanation.

It was noted on several occasions that restoration of the pO₂ to normal values following a period of hypoxia was accompanied by a further sudden constriction of the artery (Fig. 6). This suggests that during the period of hypoxia an excitatory substance (or substances) accumulated, but was unable to cause constriction of the artery because of lack of energy sources. On restoration of the pO₂ to levels above 50 mm. Hg, the energy sources could be re-synthesized and the excitatory substance caused constriction of the artery. It can still be argued that the constriction was due to the effect of rapidly changing the pO₂ across the critical threshold level, and the rapid changes from low pO₂ to high pO₂ or from high pO₂ to low pO₂ were equally effective in causing constriction of the artery.

In order to elucidate the problem, further experiments were designed. A gas mixture containing 2% CO₂ and 0% O₂ was used to produce a pCO₂ of approximately 20.0 mm. Hg together with a pO₂ of approximately 28.7 mm. Hg. As shown in Fig. 7 the constriction produced by low pCO₂ was abolished or inhibited by hypoxia, implying the need for O₂ to allow the normal constriction in re-

sponse to low pCO₂, and presumably the O₂ is required for energy production. It may also be noted that when the solution was hypoxic and hypocarbic, and the hypoxia was relieved, maintaining hypocarbia (i.e. 2% CO₂ and 0% O₂ changed to 2% CO₂ and 21% O₂), there was an initial sudden, transient contraction of the artery with rapid return to the baseline tension, followed by a more gradual constriction. The initial sudden constriction was similar to the responses observed when the pO₂ of the solution was elevated from levels below 50 mm. Hg, as described previously. The gradual later constriction was similar to the response to low pCO₂ at normal pO₂ levels, and in this experiment probably represented the effect of hypocarbia, which had been maintained after restoration of the pO₂ to normal levels. To explain the absence of a response of hypocarbia in the presence of hypoxia, it is suggested that energy sources for contraction are depleted. This would also explain why the constriction in response to hypoxia was not maintained.

Some observations can be made from the above experiments on the mechanisms whereby hypocarbia and hypoxia produce constriction of the artery. Hypocarbia produced a gradual constriction under normoxic conditions and also following a period of hypoxia and hypocarbia combined, and the magnitude of the constriction produced was similar in both cases. This suggests that at low levels of pCO₂ there is no accumulation of an excitatory substances, but that hypocarbia itself is responsible for the constriction observed. On the other hand, the sudden constriction of the artery which occurs immediately following return to normal pO₂ levels from low pO₂ levels suggests the accumulation of an excitatory substance (or substances) during the period of hypoxia. If there is an excitatory substance produced during hypoxia then one might expect that the longer the hypoxia the larger the quantity of excitatory substance produced, and the larger the magnitude of the arterial constriction until the maximum response had been reached. This was tested ex-

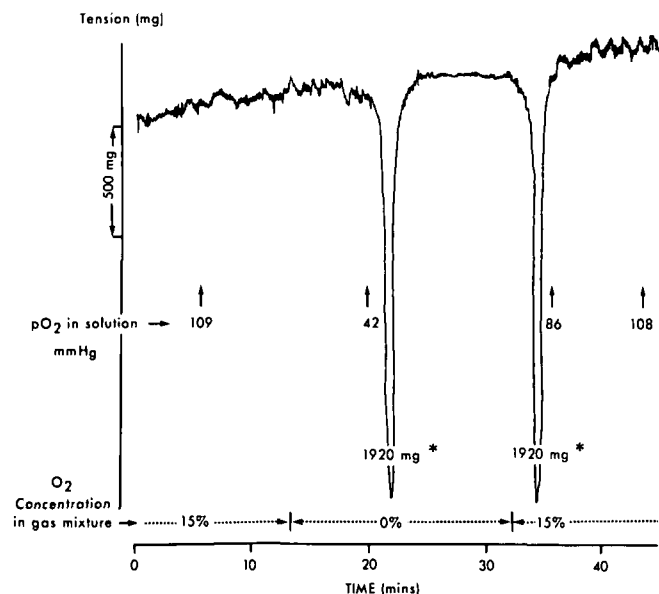

Figure 6—Response to restoration of the pO₂ in the solution to normal levels after a period of hypoxia. A downward deflection of the tension tracing represents a constriction of the vessel.

*Represents the magnitude of the constriction.

There is a transient large constriction when the pO₂ is decreased from 109 mm. Hg to 43 mm. Hg, and another similar constriction when the pO₂ is elevated to 86 mm. Hg after the period of hypoxia.

perimentally and shown to be the case (Fig. 8). In this experiment the starting pO₂ was approximately 60 mm. Hg (7% O₂ gas mixture), and this was reduced to levels below 40 mm. Hg (0% O₂ gas mixture) with period of hypoxia varying from 2.3 minutes to 6.5 minutes. It should be noted that even after only 2.3 minutes of perfusion with 0% O₂ mixture, the pO₂ of the solution was less than 40 mm. Hg. Therefore, each time the pO₂ was lowered the critical threshold range of 40 mm. to 50 mm. Hg (see above) was traversed. With the first three periods of hypoxia of 9 minutes, 8 minutes and 6.5 minutes respectively there was an increase of each successive constriction, a phenomenon that has been commented on earlier. Despite this tendency for larger constrictions with repeated episodes of hypoxia, when the periods of hypoxia were then decreased to 2.65 minutes and 2.3 minutes respectively, smaller responses were observed. That this was not due to decreased responsiveness of the vessel preparation is shown by the larger constriction in response to yet another period of hypoxia, this time lasting 5 minutes.

The findings in this experiment are not compatible with the

hypothesis that the response to hypoxia is due to a rapid change of pO₂ across a critical threshold level. There is a relationship between the duration of hypoxia and the magnitude of constriction of the vessel, supporting the hypothesis that hypoxia causes accumulation of an excitatory substance (or substances) which causes constriction of the middle cerebral artery.

DISCUSSION

In this study the direct effects of CO₂ and O₂ on the middle cerebral

artery of dogs have been investigated in vitro, using a modification of the method described by Nielsen and Owman (1971) and Allen et al (1974). These workers were investigating the effects of drugs on the middle cerebral arteries and obtained reproducible responses to the same dose of drug using different arterial segments. In the present experiments variability of the magnitude of the responses to CO₂ and O₂ was marked. Some of the factors contributing to this variability include different reactivities of the dif-

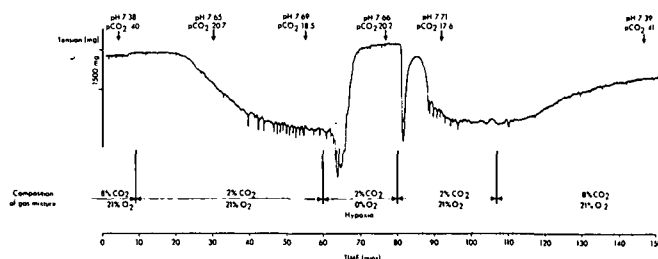

Figure 7—Effect of hypoxia on the response to changes of pCO₂. Downward deflection of the tension tracing represents vessel constriction. The constriction in response to hypocarbia is abolished by hypoxia produced by the use of a gas mixture containing 0% O₂ and 2% CO₂.

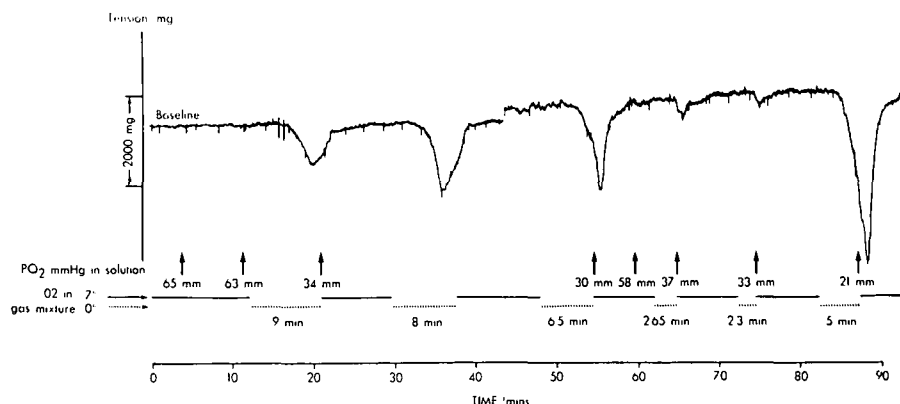

Figure 8—Response of the arterial segment of varying period of hypoxia. Downward deflection of the tension tracing represents vessel constriction. With periods of hypoxia of 2.65 minutes and 2.3 minutes respectively, there are smaller constrictions than with periods of hypoxia of 5 minutes or more.

ferent arteries, variation in the diameter and length of the arterial segment used, changes in magnitude of the response with the lapse of time after death of the animal and with the duration of time that the vessel had been mounted in the apparatus, and the amount of trauma sustained by the vessel during removal from the brain and mounting. Despite the great variability noted, semiquantitative assessments could still be made from the results.

The responses of the middle cerebral artery preparations to changes in $p\text{CO}_2$ differed slightly from what was expected. Reivich (1964) showed that in the monkey, changing the $p\text{CO}_2$ from 20 mm. Hg to 418 mm. Hg caused a stepwise increase in cerebral blood flow, with the maximum sensitivity of the response to changes in $p\text{CO}_2$ occurring at levels of $p\text{CO}_2$ near normal, i.e. around 40 mm. Hg. In the present experiments there was no response of the middle cerebral arteries to decreases in the $p\text{CO}_2$ from 38.1 mm. Hg to 26.6 mm. Hg, although there was marked constriction when the $p\text{CO}_2$ was lowered further. Increasing the $p\text{CO}_2$ from 38.1 mm. Hg to 87.2 mm. Hg resulted in a small amount of dilatation, but no information was obtained concerning the response of the vessels to lesser elevations of $p\text{CO}_2$ in the range near the normal. The arterial segments responded only when there was a large change from normal, and there is a suggestion of a threshold in the vicinity of the normal $p\text{CO}_2$, below or above which changes in the $p\text{CO}_2$ produce constriction or dilatation. The existence of a threshold phenomenon determining the cerebral blood flow response to $p\text{CO}_2$ has previously been suggested by Patterson et al (1955) but because of the wide scatter of the responses, their data could just as easily be interpreted as a continuous function. It may be that in vivo the sensitivity of the cerebral vessels to changes in $p\text{CO}_2$ is increased by the interaction of nervous and humoral factors, so that the range of $p\text{CO}_2$ through which no change in cerebral blood flow occurs is small, and this threshold phenomenon can then be obscured

by widely scattered results.

It should be pointed out that during these experiments changes of $p\text{CO}_2$ were invariably associated with changes in pH. An increased $p\text{CO}_2$ was accompanied by a decrease in the pH and vice versa. Since the pH changes varied from 6.95 to 7.60 and might have affected the middle cerebral arteries in a similar manner to the $p\text{CO}_2$ changes, it is not possible to say whether the responses observed with changes in $p\text{CO}_2$ were due to a direct effect of CO_2 on the vessels or an indirect effect via changes in pH.

The responses of the middle cerebral artery preparations to changes in the $p\text{O}_2$ were completely at variance with the expected responses based on in vivo studies. Betz (1965) found that lowering the inspired O_2 concentration to 16% or less caused a decrease in cerebrovascular resistance with increased cerebral blood flow, and the response became more and more marked as the arterial $p\text{O}_2$ fell below 50 mm. Hg until consciousness was lost at a jugular venous $p\text{O}_2$ of 19 mm. Hg. The response to increases in $p\text{O}_2$ was less marked, with a decrease in cerebral blood flow of up to 15% occurring with inhalation of 100% O_2 at normal atmospheric pressure.

In the present study there was no response of the middle cerebral arteries to changes of the $p\text{O}_2$ from > 500 mm. Hg to 59.6 mm. Hg. However, as the $p\text{O}_2$ was decreased below 59.6 mm. Hg there was a dramatic and unexpected constriction of the artery. The constriction occurred when the $p\text{O}_2$ fell below 50 mm. Hg, and was of great magnitude, but brief duration. Repeated lowering of the $p\text{O}_2$ below 50 mm. Hg in a single preparation produced progressively larger contractions. In some way the response to hypoxia is potentiated by a previous period of hypoxia.

It was noted that the constriction of the middle cerebral arteries in response to lowering of the $p\text{O}_2$ below 50 mm. Hg was brief and that the artery relaxed again despite the maintenance of the hypoxia. It has been hypothesized that the brevity of the contraction is related to a lack

of energy sources to permit prolonged contraction. As one might expect, the contraction occurring in response to hypocarbia was abolished or inhibited by lowering the $p\text{O}_2$ to < 50 mm. Hg (Fig. 7), supporting this hypothesis. Furthermore, elevation of the $p\text{O}_2$ following a period of hypoxia sometimes resulted in another sudden contraction of the artery, suggesting that an excitatory substance produced during the period of hypoxia had attached to receptors on the arterial segment, but could cause contraction only when energy sources were again made available by elevation of the $p\text{O}_2$. If this were true, then one would expect that the longer the period of hypoxia the greater the amount of excitatory substance produced, and the greater the magnitude of the contraction in response to hypoxia. It was shown (Fig. 8) that the magnitude of the response to hypoxia was directly related to the duration of hypoxia, as predicted by the hypothesis.

The explanation and significance of this response to hypoxia are unclear. Certainly no such response has been previously reported in living animals and man, and it may be that in vivo, other factors modulate the response to changes in $p\text{O}_2$, so that the direct effects of hypoxia are not observed. The levels of $p\text{O}_2$ at which this response occurs are very low, but not unheard of clinically. Such low $p\text{O}_2$ levels are seen in patients with airway obstruction, following anaesthetic accidents and cardiac arrest. An important question, therefore, is whether the response to hypoxia that we have noted, does occur in vivo in pathological conditions when there may be a breakdown in the mechanisms that normally modulate the response of the cerebral vasculature to hypoxia. At present we can only speculate on this.

ACKNOWLEDGEMENTS

The cooperation of Dr. W. G. Trapp and the Hyperbaric Research Unit is gratefully acknowledged. This project was supported by Medical Research Council of Canada, Grant Number MA-3890.

REFERENCES

- ALLEN, G. S., HENDERSON, L. M., CHOU, S. N. and FRENCH, L. A. (1974). Cerebral arterial spasm. Part I: In vitro contractile activity of vasoactive agents on canine basilar and middle cerebral arteries. *J. Neurosurg.*, 40: 433-441.
- BETZ, E. (1972). Adaptation of regional cerebral blood flow in animals exposed to chronic alterations of pO₂ and pCO₂. *Acta. Neurol. Scand.*, Suppl. 14, 121-128.
- BETZ, E. (1972). Cerebral blood flow: its measurement and regulation. *Physiological Review*, 52: 595-630.
- BETZ, E. and HEUSER, D. (1967). Cerebral cortical blood flow during changes of acid-base equilibrium of the brain. *J. Appl. Physiol.*, 23, 726-733.
- BOHR, D. F., GOULET, P. L. and TAQUINI, A. C. (1961). Direct tension recording from smooth muscle of resistance vessels from various organ. *Angiology*, 12, 478-485.
- BRONK, D. W. and GESELL, R. (1927). The regulation of respiration X Effect of carbon dioxide, sodium bicarbonate and sodium carbonate on the carotid and femoral flow of blood. *Amer. J. Physiol.*, 82, 170-180.
- CHOROBSKI, J. and PENFIELD, W. (1932). Cerebral vasodilator nerves and their pathway from the medulla oblongata. *Arch. Neurol. Psychiat.* (Chicago), 28, 1257-1289.
- COW, D. (1911). Some reactions of surviving arteries. *J. Physiol.* (London), 42, 125-143.
- DAHL, N. A. and BALFOUR, W. M. (1964). Prolonged anoxic survival due to anoxia pre-exposure: brain, ATP, lactate and pyruvate. *Amer. J. Physiol.*, 207, 452-455.
- DETAR, R. and BOHR, D. F. (1968). Adaptation to hypoxia in vascular smooth muscle. *Federation Proc.*, 27, 1416-1419.
- DUMKE, P. R. and SCHMIDT, C. F. (1943). Quantitative measurement of cerebral blood flow in the Macaque monkey. *Amer. J. Physiol.*, 138, 421-431.
- FALCK, B., NIELSON, K. C. and OWMAN, C. (1968). Adrenergic innervation of the pial circulation. *Scan. J. Clin. Lab. Invest.*, Suppl. 102, Sect. VI B.
- FORBES, H. S., SCHMIDT, C. F. and NASON, G. I. (1939). Evidence of vasodilator innervation in the parietal cortex of the cat. *Am. J. Physiol.* 125, 216-219.
- GURDJIAN, E. S., WEBSTER, J. E., MARTIN, F. A. and THOMAS, L. M. (1958). Cinematographic of the pial circulation. A study of factors influencing vascular caliber; preliminary report. *A.M.A. Arch. Neurol. Psychiat.*, 80, 418-435.
- HARPER, A. M. and BELL, R. A. (1963). The effect of metabolic acidosis and alkalosis in the blood flow through the cerebral cortex. *J. Neurol. Neurosurg. Psychiat.*, 26, 341-344.
- HARPER, A. M., DESHMUKH, V. D., ROWAN, J. O. and JENNETT, W. B. (1971). Studies of possible neurogenic influences on the cerebral circulation. In *Brain and Blood Flow*. Edit. R. W. Ross Russell, London, Pitman, pp. 182-186.
- JAMES, I. M., MILLAR, R. A. and PURVES, M. J. (1969). Observations on the extrinsic neural control of cerebral blood flow in the baboon. *Circ. Res.*, 25, 77-93.
- KETY, S. and SCHMIDT, C. F. (1948). The effects of altered arterial tension of carbon dioxide and oxygen on cerebral blood flow and cerebral oxygen consumption of normal young men. *J. Clin. Invest.*, 27, 484-492.
- LAMBERTSEN, C. J., SEMPLE, S. J. G., SMYTH, M. G. and GELFAND, R. (1961). Hydrogen ion and pCO₂ as chemical factors in respiratory and cerebral circulatory control. *J. Appl. Physiol.* 16, 473-484.
- LASSEN, N. A. (1966). The luxury-perfusion syndrome and its possible relation to acute metabolic acidosis localized within the brain. *Lancet*, ii, 1113-1115.
- LAVRETIEVA, N. B., McHEDLISHVILI, G. I. and PLETCHKOVA, E. K. (1968). Distribution and activity of cholinesterase in the nervous structures of the pial arteries (a histochemical study). *Bull. Exptl. Biol. Med.*, 64, 110-113.
- MEYER, J. S. and GOTOH, F. (1961). Interaction of cerebral hemodynamics and metabolism. *Neurology*, 11, Part 2, 46-65.
- MEYER, J. S., GOTOH, F., EBINHERA, S. and TOMITA, M. (1965). Effects of anoxia on cerebral metabolism and electrolytes in man. *Neurology* (Minneapolis), 15, 892-901.
- MEYER, J. S., YOSHIDA, K. and SAKAMOTO, K. (1967). Autonomic control of cerebral blood flow measured by electromagnetic flowmeters. *Neurology* (Minneapolis), 17, 638-648.
- MEYER, J. S. and WELCH, K. M. A. (1972). Relationship of cerebral blood flow and metabolism to neurological symptoms. *Prog. Brain Res.*, 35, 285-347.
- NELSON, E. and RENNELS, M. (1970). Innervation of intracranial arteries. *Brain*, 93, 475-490.
- NIELSEN, K. C. and OWMAN, C. (1967). Adrenergic innervation of pial arteries related to the circle of Willis in the cat. *Brain Res.*, 6, 773-776.
- NIELSEN, K. C. and OWMAN, C. (1971). Contractile response and amine receptor mechanisms in isolated middle cerebral artery of the cat. *Brain Res.*, 27, 33-42.
- NIELSEN, K. C., OWMAN, C. H. and SPORRONG, B. (1971). Ultrastructure of the autonomic innervation apparatus in the main pial arteries of rats and cats. *Brain Res.*, 27, 25-32.
- PATTERSON, J. L., HEYMAN, A., BATTLEY, L. L. and FERGUSON, R. W. (1955). Threshold of response of the cerebral vessels of man to increase in blood carbon dioxide. *J. Clin. Invest.*, 34, 1957-1864.
- PEERLESS, S. J. and YASARGIL, M. G. (1971). Adrenergic innervation of cerebral blood vessels in the rabbit. *J. Neurosurg.*, 35, 148-154.
- PEERLESS, S. J., YASARGIL, M. G. and KENDALL, M. J. (1972). The adrenergic and cholinergic innervation of the cerebral blood vessels. In *Present Limits of Neurosurgery*. Edit. Fusek, I. and Kunc, Z., Avicenum, Czechoslovak Medical Press, Prague, 1972.
- PEERLESS, S. J. and KENDALL, M. J. (1975). The innervation of cerebral blood vessels. Chapter in *Subarachnoid Hemorrhage and Cerebrovascular Spasm*. Edit. Robert R. Smith and James T. Robertson, Charles C. Thomas, Springfield, Illinois, 1975.
- PENFIELD, W. (1932). Intracerebral vascular nerves. *Arch. Neurol. Psychiat.*, 27, 30-44.
- REIVICH, M. (1964). Arterial pCO₂ and cerebral hemodynamics. *Amer. J. Physiol.*, 206, 25-35.
- REIVICH, M. (1969). Regulation of the cerebral circulation. *Clin. Neurosurg.*, 16, 378-418.
- SCHIEVE, J. F. and WILSON, W. P. (1953). The changes in cerebral vascular resistance of man in experimental alkalosis and acidosis. *J. Clin. Invest.*, 32, 33-38.
- SEVERINGHAUS, J. W. (1965). Regulation of pH on the cerebral cortex. *J. Physiol.* (Lond.), 181, 35P.
- SEVERINGHAUS, J. W. (1965). Role of cerebrospinal fluid pH in normalization of cerebral blood flow in chronic hypocapnia. *Acta Neurol. Scand.*, Suppl. 14, 116-120.
- SEVERINGHAUS, J. W., CHIODI, H., EGER II, E. I., BRANDSTATER, B. and HORNBEIN, T. F. (1966). Cerebral blood flow in man at high altitude. *Circ. Res.*, 19, 274-282.
- SEVERINGHAUS, J. W. and LASSEN, N. A. (1967). Step hypocapnia to separate arterial from tissue pCO₂ in the regulation of cerebral blood flow. *Circ. Res.*, 20, 272-278.
- SEVERINGHAUS, J. W. and LASSEN, N. A. (1968). Cerebral blood flow control by arterial and not by tissue pCO₂ as evidence from CBF changes after step hypocapnia. *Scand. J. Lab and Clin. Invest.*, Suppl. 102, VII B.
- SOKOLOFF, L. (1959). The action of drugs on the cerebral circulation. *Pharmacol. Rev.*, 11, 1-85.
- SOKOLOFF, L. (1960). The effects of carbon dioxide on the cerebral circulation. *Anesthesiology*, 21, 664-673.
- SUNDT, T. M. (1973). The cerebral autonomic nervous system. *Mayo Clin. Proc.*, 48, 127-137.
- UCHIDA, E., BOHR, D. F. and HOUBLER, S. W. (1967). A method for studying isolated resistance vessels from rabbit mesentery and brain and their responses to drugs. *Circ. Res.*, 21, 525-536, 1967.
- WOLFF, H. G. (1936). The cerebral circulation. *Physiol. Rev.*, 16, 545-595.